

Model #

3512GAC

3512CAF

McKenzie Round Cocktail Table (40"D)

GAC = Glazed Antique Cherry finish

CAF = Caffè finish

Assembly Instructions

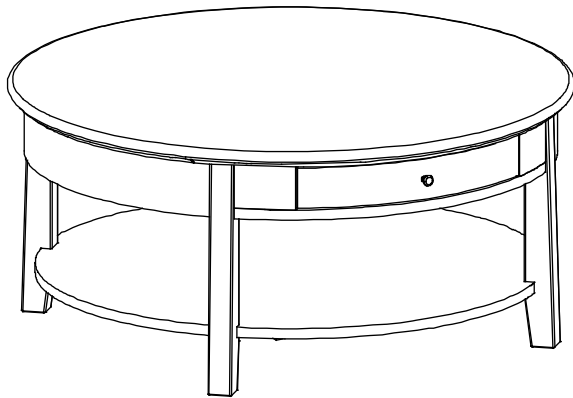

Thank you for allowing us to help you furnish your home. We are certain you will be delighted with your new furniture for many years to come.

IMPORTANT NOTES:

- For normal household use only. *Not* recommended for commercial use.
- Do not climb, sit or stand on this piece of furniture.
- Unload items before you move this unit.
- Do not overload the shelf or drawer.

WARNING

Drilling, sawing, sanding or machining wood products can expose you to wood dust, a substance known to the state of California to cause cancer. Avoid inhaling wood dust or use a dust mask or other safeguards for personal protection.

For more information go to: www.p65warnings.ca.gov/wood

This product can expose you to chemicals, including formaldehyde, which are known to the State of California to cause cancer.

For more information go to: www.p65warnings.ca.gov/furniture

DESIGN SUBJECT TO CHANGE WITHOUT NOTICE.

CUSTOMER SERVICE

If you ever have questions about your furniture, please do not hesitate to contact us. In the unlikely event you need a replacement part; we can make those parts available through an authorized Whittier Wood Furniture dealer. If you cannot order replacement parts through your dealer, please contact our customer service department.

Hours: Our friendly customer service staff can be reached:

Monday-Friday 8:00 a.m. to 5:00 p.m. (Pacific Time).

You may leave a message 24 hours a day, seven days a week.

Customer Service: 800-653-3336 • **Outside the U.S.:** 541-687-0213

Fax: 541-687-2060 • **Email:** info@whittierwood.com

**Whittier
Wood**
FURNITURE

P.O. Box 2827
Eugene, OR 97402 USA

Production Code:











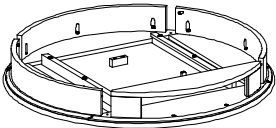

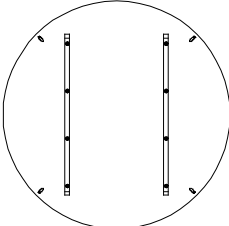
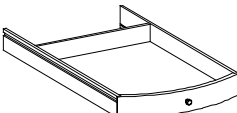
VN

12/19

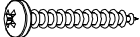
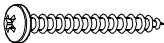
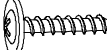
3512GAC 3512CAF McKenzie Round Cocktail Table (40"D)

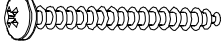
Parts List

Please identify the parts and check that quantities received match those on this list.
If you need to replace a part, refer to the following letter and part name.

Part	Description		Quantity
A	Top Assembly		1
B	Leg		4
C	Shelf		1
D	Drawer (inserted)		1
E	Wood Slide (installed)		2
F	Drawer Stop (attached)		1
G	#8 x 1-3/8" Lo-Profile Screw (inserted)		9
H	#8 x 1" Pan Head Screw (inserted)		16
I	#8 x 1-1/4" Pan Head Screw		24 (12 inserted)
J	#8 x 7/8" Black Lo-Profile Screw (inserted)		1
K	4 x 25mm Machine Screw (installed)		1
L	#10 x 2" Pan Head Screw (inserted)		6
M	#8 Washer (inserted)		14
N	1/4" x 20mm Insert Nut (inserted)		4
O	Knob (attached)		1
P	Adjustable Glide (installed)		4

3512GAC 3512CAF McKenzie Round Cocktail Table (40"D)

Assembly Instructions

Tools Required: Phillips Screwdriver, Rubber Mallet or Padded Hammer

1. Turn the Top Assembly (A) upside down on a clean, protected surface. Position the Drawer Stop (F) so that it is unlocked, remove the Drawer (D) and place it off to the side. See Figures 1, 1a and 1b.

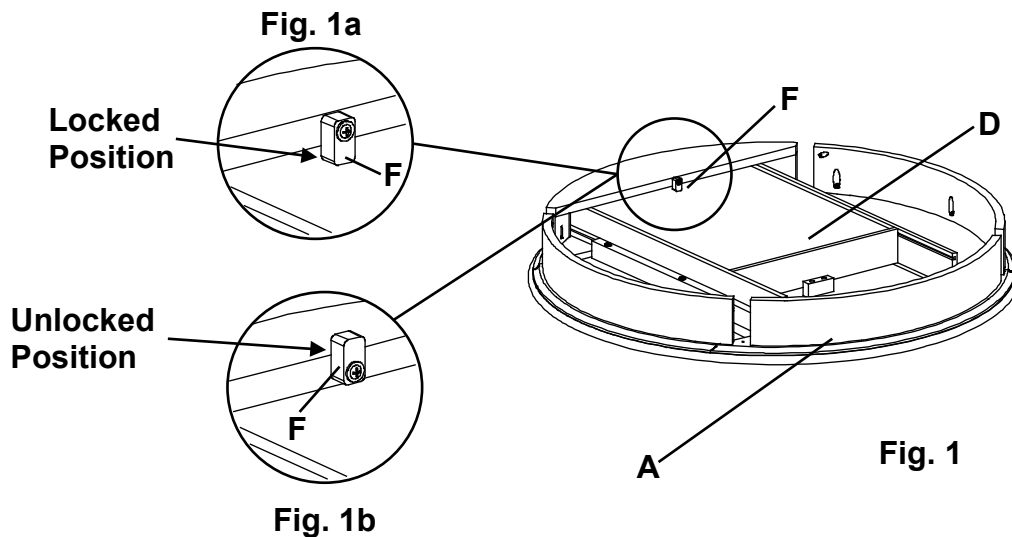

2. Place a Leg (B) in a corner of the Top Assembly (A). See Figure 2.

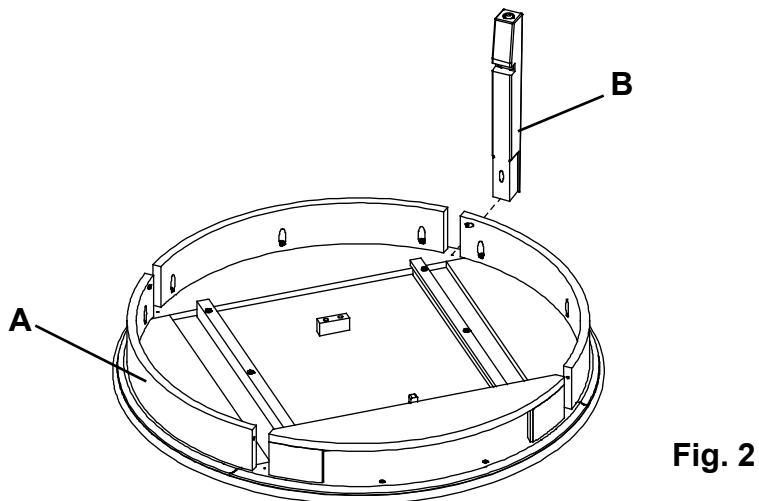

3512GAC 3512CAF McKenzie Round Cocktail Table (40"D)

Assembly Instructions

3. Using the pocket hole as a guide, secure the Leg (B) to the Top Assembly (A) with one #8 x 1-1/4" Pan Head Screw (I). See Figures 3 and 3a.

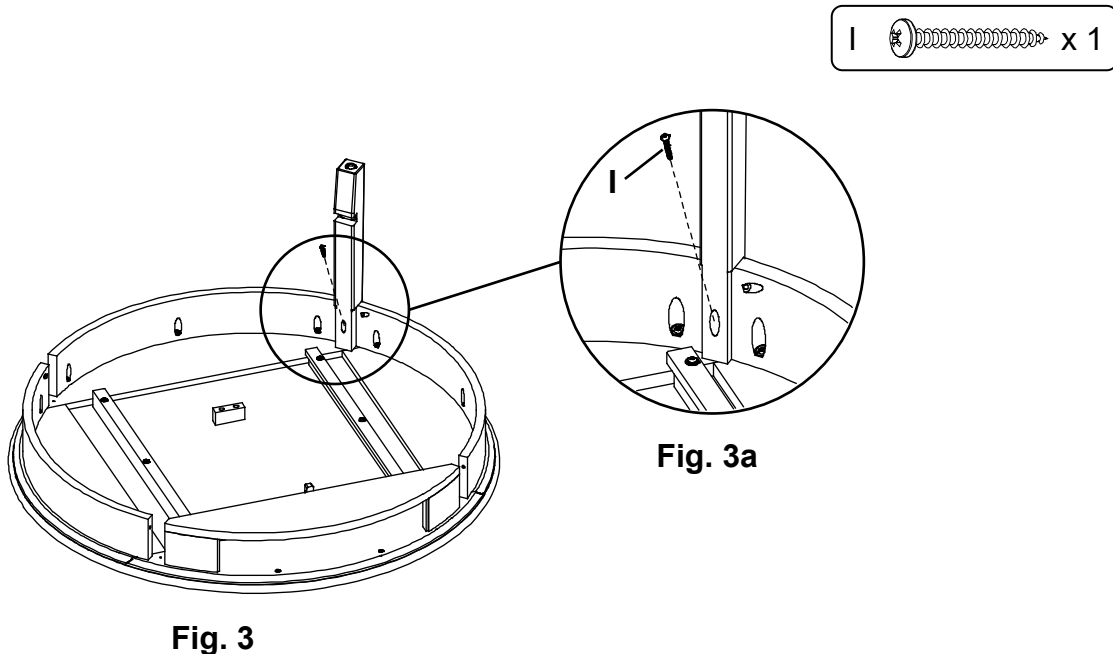

4. Place a second Leg (B) in a corner of the Top Assembly (A) and using the pocket hole as a guide, secure the Leg (B) with one #8 x 1-1/4" Pan Head Screw (I). See Figure 4.

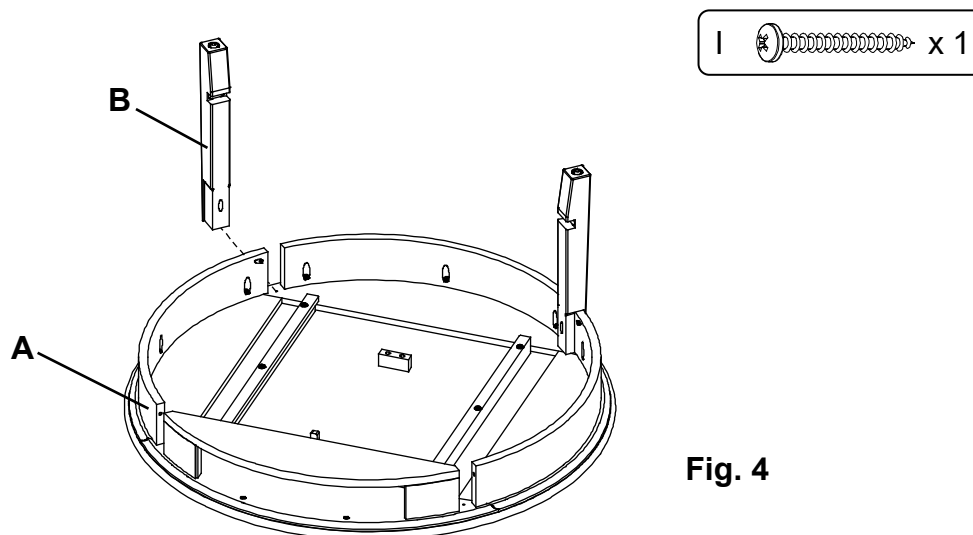

3512GAC 3512CAF McKenzie Round Cocktail Table (40"D)

Assembly Instructions

5. Place a third Leg (B) in a corner of the Top Assembly (A) and using the pocket hole as a guide, secure the Leg (B) with one #8 x 1-1/4" Pan Head Screw (I). See Figure 5.

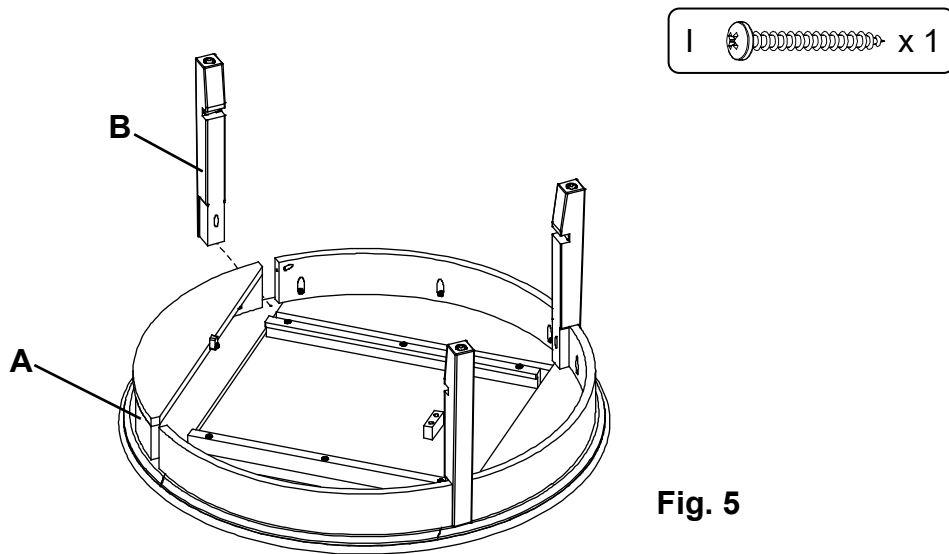

6. To attach the Shelf (C) align three of the pocket screw holes with the notches of the legs and slide the Shelf (C) into the notches. Be sure the grain of the Shelf (C) is in line with the grain of the top. Place the final Leg (B) in the remaining corner, using the pocket hole as a guide, secure the Leg (B) with one #8 x 1-1/4" Pan Head Screw (I). See Figure 6.

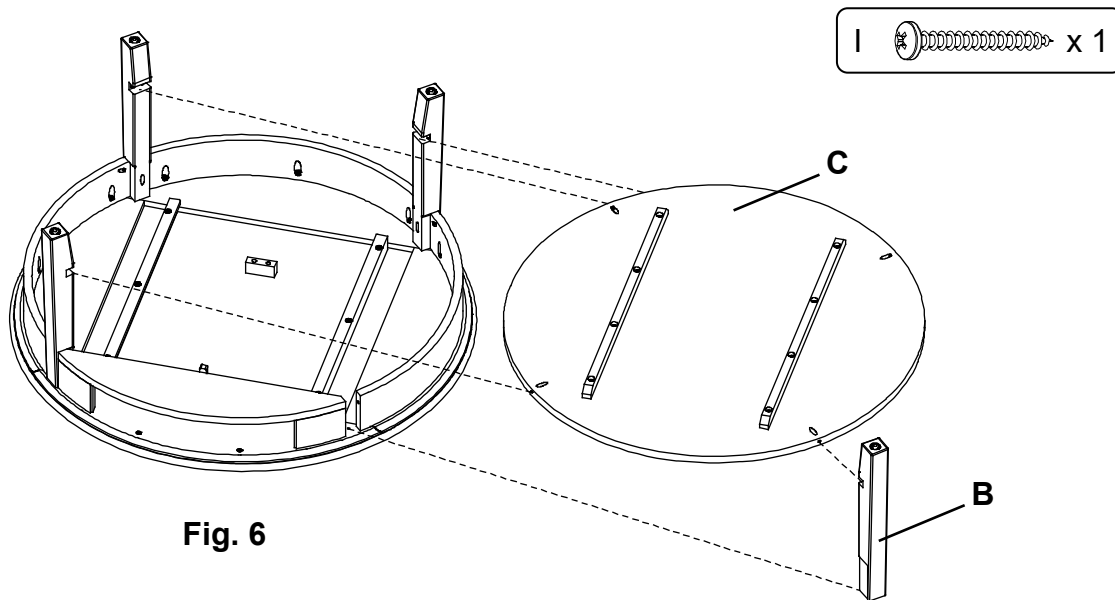

3512GAC 3512CAF McKenzie Round Cocktail Table (40"D)

Assembly Instructions

7. Using the pocket holes as guides, secure the Shelf (C) to the Legs (B) with four #8 x 1-1/4" Pan Head Screws (I). See Figures 7 and 7a.

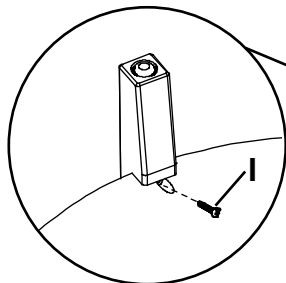
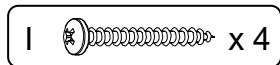

Fig. 7a

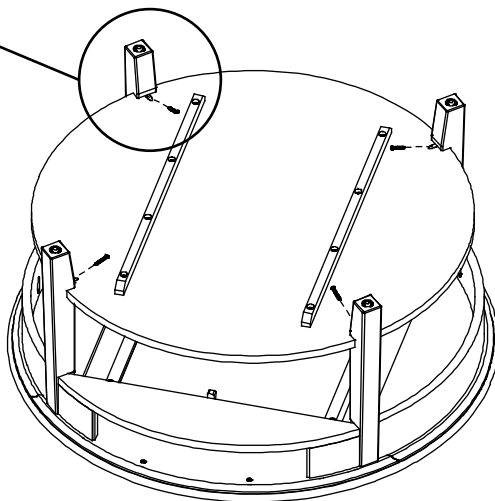

Fig. 7

8. Using the pocket holes as guides, secure the side aprons to the Legs (B) with four #8 x 1-1/4" Pan Head Screws (I). See Figures 8 and 8a.

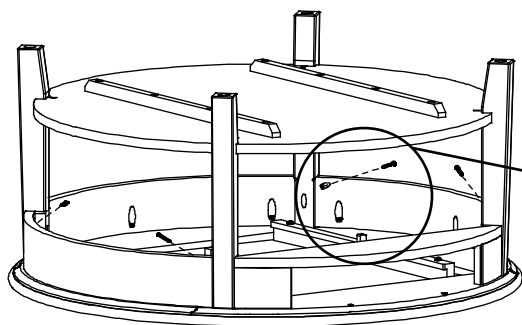
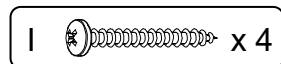

Fig. 8

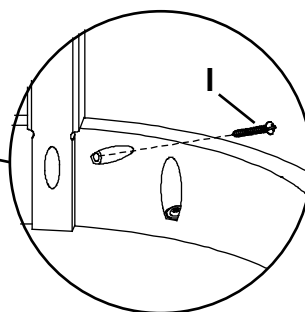
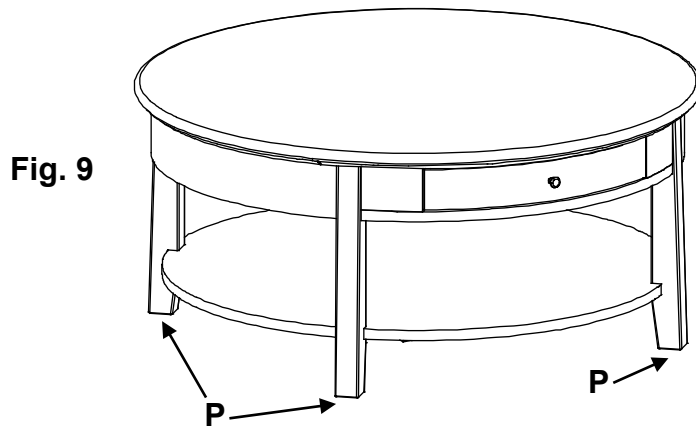

Fig. 8a

3512GAC 3512CAF McKenzie Round Cocktail Table (40"D) Assembly Instructions

9. Turn the table upright and insert the Drawer (D). Rotate the Drawer Stop (F) back to the locked position. See Figure 9.



10. Place the table at its final destination. To level the table, rotate the Adjustable Glides (P) found on the bottoms of the legs. See Figure 9.