

PWVH18-448

Halogen lights. WBAR warming light bar is available on selected models.

Dimensional Information

Width	48.0
Depth	24.0
Height	18.0
CFM @ 0.0" SP	1200.0
Sones	6.6
Amps	7.3
# Lights	3.0

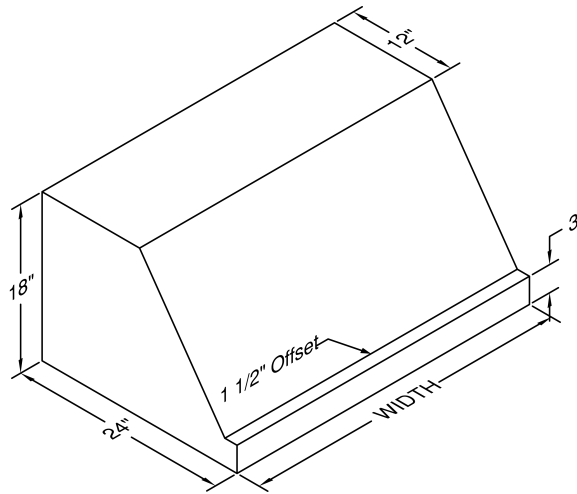

Connection Diagram

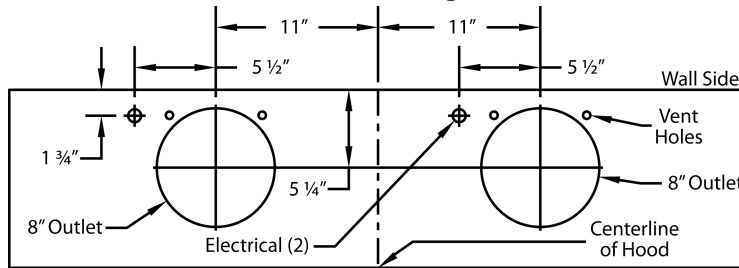

1200 CFM Double B200 Dual Blowers (Top View)

Recommended Mounting Height*

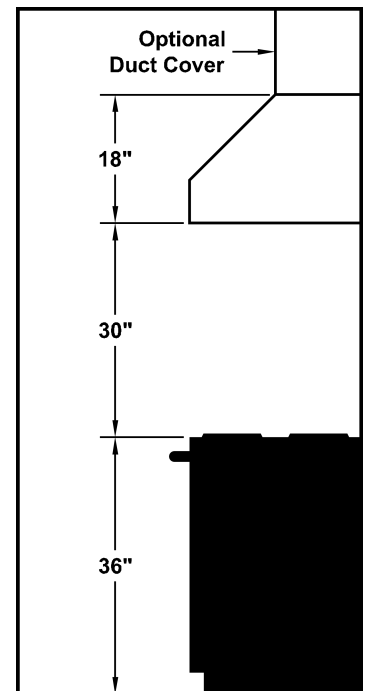

*Exceeding recommended mounting height may compromise performance.

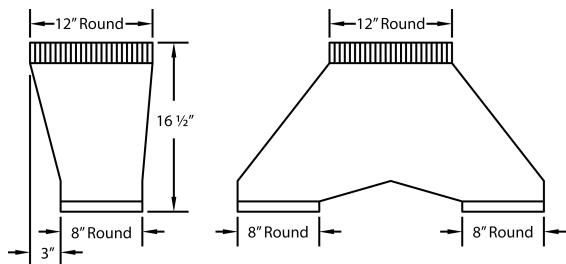

VP563 Transition (Optional) For B400 (Double B200 Dual Blowers)

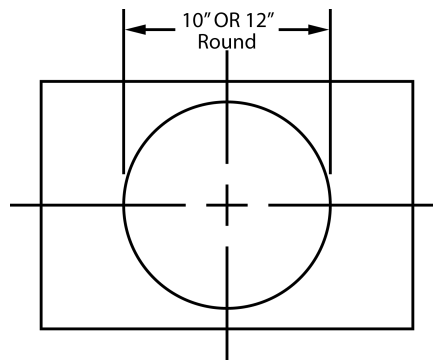

VP563 transition centers outlet over top of hood.

Electrical/Mechanical Specifications For Blower Unit

Model	Volts	Amps*	Hz	RPM	CFM SP@0.0"	Equivalent CFM	CFM SP@0.1"	CFM SP@0.2"	CFM SP@0.3"	Minimum Round Duct Size	Sones#
Two B200 Duals	115.0	5.8	60.0	1550.0	1200.0	1800.0	1062.0	960.0	860.0	12" (113 sq. in.)	6.6

+ Add 2.5 amps for each warming light. This model is equipped with halogen lighting: (2 lights: 30" - 41", 3 lights: 42" - 48").

\$ Because the Magic Lung® blower uses centrifugal filtration rather than conventional baffle or mesh filters, the Magic Lung® blower can handle cooking equipment with higher cubic feet per minute (CFM) requirements and can deliver equivalent CFM much more efficiently than other filtration systems. When comparing the Magic Lung® with other blower units made by other manufacturers, use the "Equivalent CFM".

Ratings in accordance with the Standard Test Code by the Energy Systems Laboratory of the Texas Engineering Experiment Station.