

Model Number: JPH360/C1

Special Notes: LED lights. This model is not available with heat lamps.

WIDTH:	60"
DEPTH:	24"
HEIGHT:	30"
CFM:	900
SONES:	6.3
AMPS:	6.0
# LIGHTS:	4

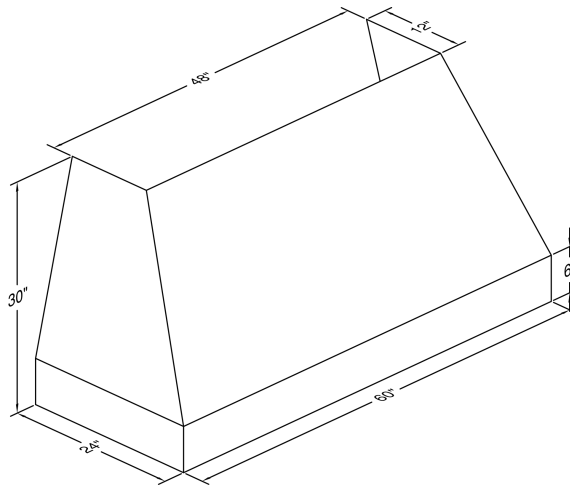

CONNECTION DIAGRAM

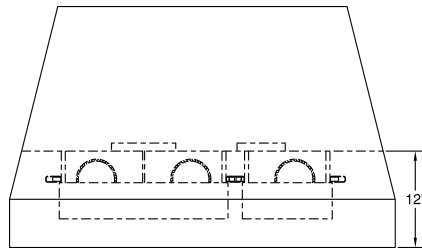
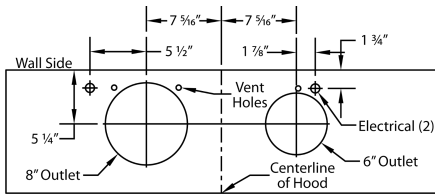

REC. MOUNTING HEIGHT*

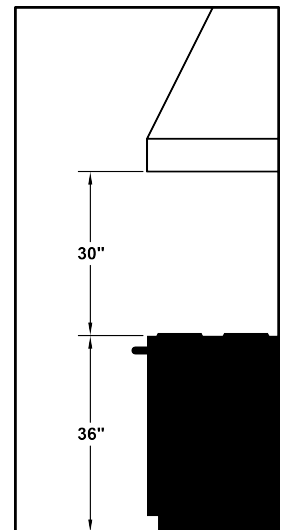

* Exceeding recommended mounting height may compromise performance.

900 CFM B200 Dual & B100 Single Blower (Top View)

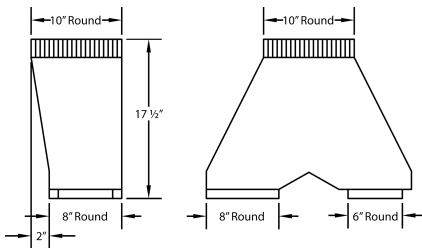

(Front View)

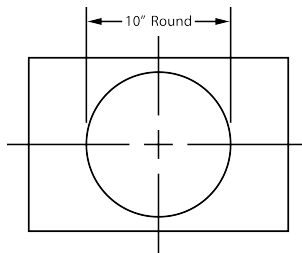

VP562 Transition (Optional) For B300 (B200 Dual Blower & B100 Single Blower)

VP562 transition centers outlet over top of hood.

ELECTRICAL/MECHANICAL SPECIFICATIONS FOR BLOWER UNIT

MODEL	VOLTS	AMPS+	HZ	RPM	CFM SP@0.0"	EQUIV CFM\$	CFM SP@0.1"	CFM SP@0.2"	CFM SP@0.3"	MIN. ROUND DUCT SIZE	SONES#
B200 Dual & B100 Single	115	6.0	60	1550	900	1350	804	725	655	10" (79 sq. in.)	6.3

+ This model is equipped with LED lighting: (2 lights: 30" - 41", 3 lights: 42" - 53", 4 lights: 54" - 66").

\$ Because the Magic Lung blower uses centrifugal filtration rather than conventional baffle or mesh filters, the Magic Lung blower can handle cooking equipment with higher cubic feet per minute (CFM) requirements and can deliver equivalent CFM much more efficiently than other filtration systems. When comparing the Magic Lung with other blower units made by other manufacturers, use the "Equivalent CFM".

Ratings in accordance with the Standard Test Code by the Energy Systems Laboratory of the Texas Engineering Experiment Station.