

WIDTH:	66"
DEPTH:	30"
HEIGHT:	30"
CFM:	1100
SONES:	6.4
AMPS:	7.5
# LIGHTS:	4

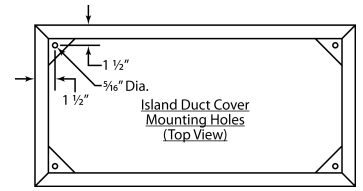

CONNECTION DIAGRAM

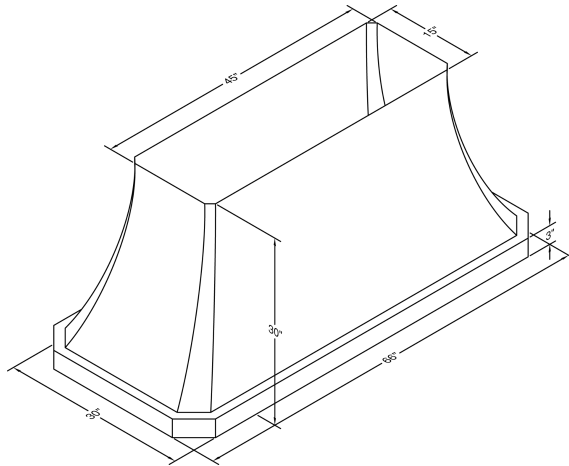
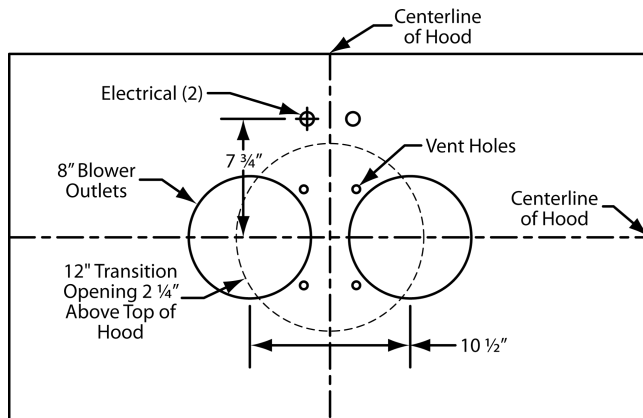

1100 CFM T400 Cluster Blower (Top View)

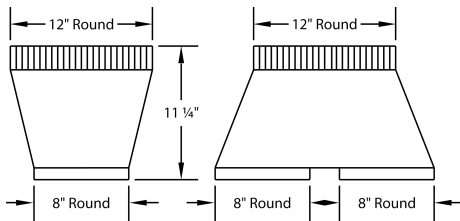

VP564 Standard Transition (Included)

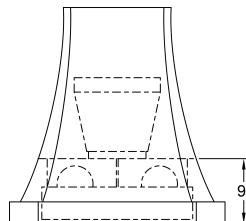

Transition Installed (Side View)

REC. MOUNTING HEIGHT*

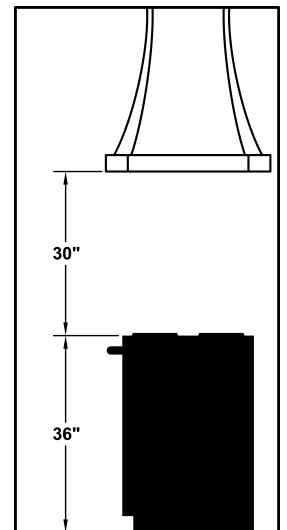

* Exceeding recommended mounting height may compromise performance.

ELECTRICAL/MECHANICAL SPECIFICATIONS FOR BLOWER UNIT

MODEL	VOLTS	AMPS+	HZ	RPM	CFM SP@0.0"	EQUIV CFM\$	CFM SP@0.1"	CFM SP@0.2"	CFM SP@0.3"	MIN. ROUND DUCT SIZE	SONES#
T400 Island Cluster	115	7.5	60	1550	1100	1800	998	855	774	12" (113 sq. in.)	6.4

+ This model is equipped with LED lighting (one in each corner).

\$ Because the Magic Lung blower uses centrifugal filtration rather than conventional baffle or mesh filters, the Magic Lung blower can handle cooking equipment with higher cubic feet per minute (CFM) requirements and can deliver equivalent CFM much more efficiently than other filtration systems. When comparing the Magic Lung with other blower units made by other manufacturers, use the "Equivalent CFM".

Ratings in accordance with the Standard Test Code by the Energy Systems Laboratory of the Texas Engineering Experiment Station.