

Model Number: JCIH242/A1

Special Notes: LED lights. This model is not available with heat lamps. Shown with optional 8' ceiling duct cover (sold separately). Optional duct covers are available in standard sizes. Duct cover top sizes may vary with height.

WIDTH:	42"
DEPTH:	30"
HEIGHT:	30"
CFM:	550
SONES:	6.0
AMPS:	4.0
# LIGHTS:	4

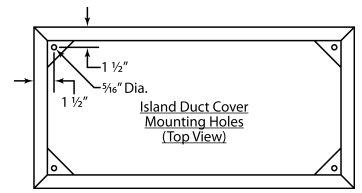
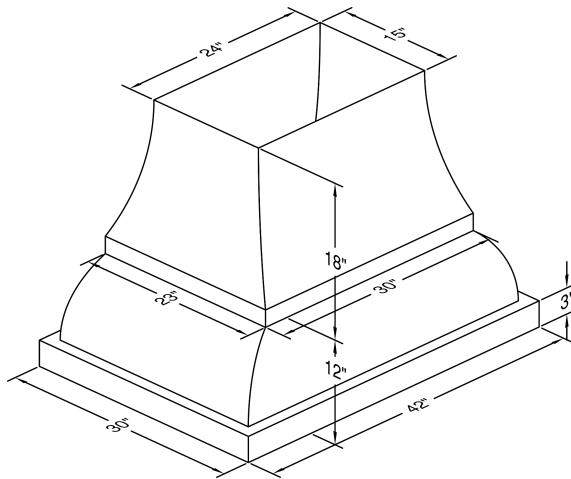

CONNECTION DIAGRAM

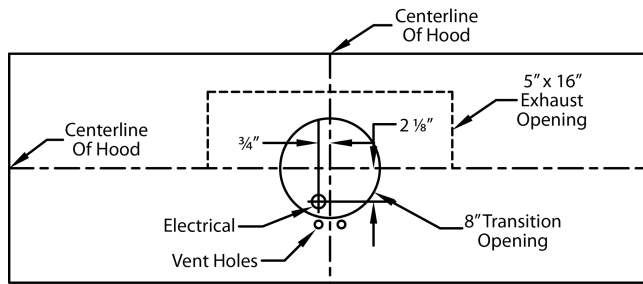

REC. MOUNTING HEIGHT*

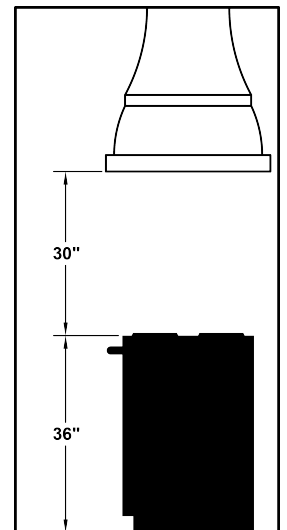

* Exceeding recommended mounting height may compromise performance.

550 CFM T200 Dual Blower (Top View)

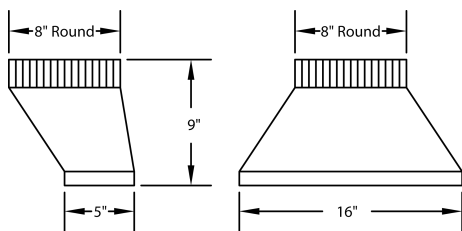

VP565 Standard Transition (Included)

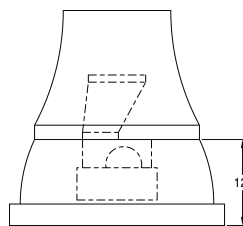

Transition Installed (Side View)

ELECTRICAL/MECHANICAL SPECIFICATIONS FOR BLOWER UNIT

MODEL	VOLTS	AMPS+	HZ	RPM	CFM SP@0.0"	EQUIV CFM\$	CFM SP@0.1"	CFM SP@0.2"	CFM SP@0.3"	MIN. ROUND DUCT SIZE	SONES#
T200 Island Dual	115	4.0	60	1550	550	900	507	471	431	8" (50 sq. in.)	6.0

+ This model is equipped with LED lighting (one in each corner).

\$ Because the Magic Lung blower uses centrifugal filtration rather than conventional baffle or mesh filters, the Magic Lung blower can handle cooking equipment with higher cubic feet per minute (CFM) requirements and can deliver equivalent CFM much more efficiently than other filtration systems. When comparing the Magic Lung with other blower units made by other manufacturers, use the "Equivalent CFM".

Ratings in accordance with the Standard Test Code by the Energy Systems Laboratory of the Texas Engineering Experiment Station.