

### CXH30-136

Halogen lights. WBAR warming light bar is available on selected models.

#### Dimensional Information

Width	36.0
Depth	24.0
Height	30.0
CFM @ 0.0" SP	300.0
Sones	5.4
Amps	2.5
# Lights	2.0

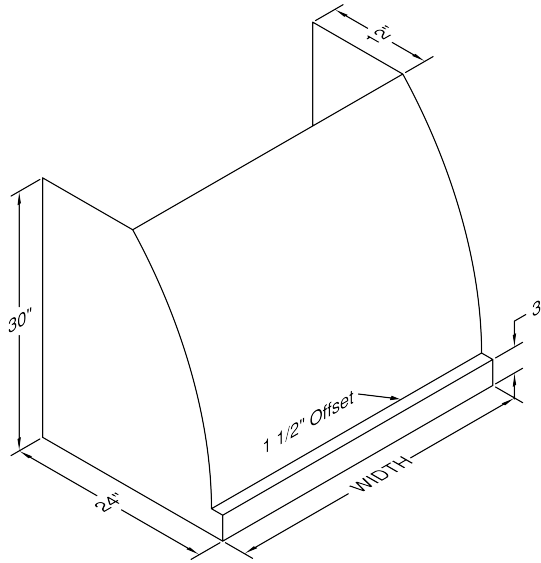

#### Connection Diagram

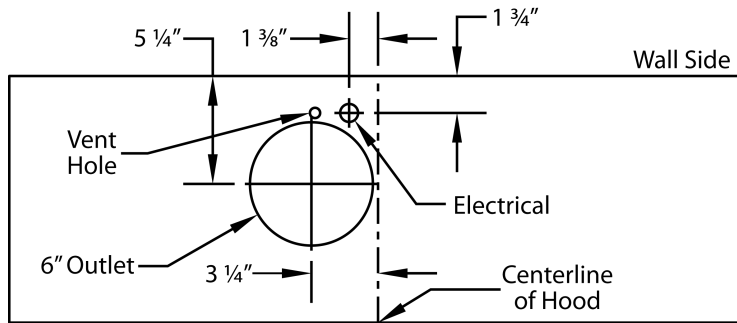

300 CFM B100 Single Blower (Top View)

#### Recommended Mounting Height\*

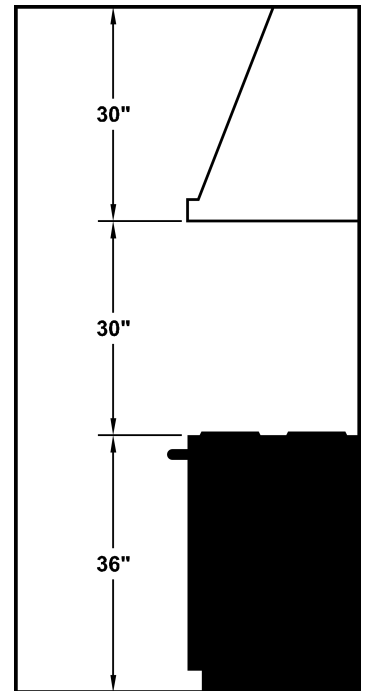

\*Exceeding recommended mounting height may compromise performance.

#### Electrical/Mechanical Specifications For Blower Unit

Model	Volts	Amps*	Hz	RPM	CFM SP@0.0"	Equivalent CFM	CFM SP@0.1"	CFM SP@0.2"	CFM SP@0.3"	Minimum Round Duct Size	Sones#
B100 Single	115.0	1.5	60.0	1550.0	300.0	450.0	273.0	245.0	225.0	6" (28 sq. in.)	5.4

+ Add 2.5 amps for each warming light. This model is equipped with halogen lighting: (2 lights: 30" - 41", 3 lights: 42" - 53", 4 lights: 54" - 66").

\$ Because the Magic Lung® blower uses centrifugal filtration rather than conventional baffle or mesh filters, the Magic Lung® blower can handle cooking equipment with higher cubic feet per minute (CFM) requirements and can deliver equivalent CFM much more efficiently than other filtration systems. When comparing the Magic Lung® with other blower units made by other manufacturers, use the "Equivalent CFM".

# Ratings in accordance with the Standard Test Code by the Energy Systems Laboratory of the Texas Engineering Experiment Station.