

**Model Number: CWSH3-1/042-21**

Special Notes: LED lights. This model is not available with heat lamps. Shown with included duct cover for 7' ceiling.

|                  |     |
|------------------|-----|
| <b>WIDTH:</b>    | 42" |
| <b>DEPTH:</b>    | 21" |
| <b>HEIGHT:</b>   | 24" |
| <b>CFM:</b>      | 300 |
| <b>SONES:</b>    | 5.4 |
| <b>AMPS:</b>     | 2.5 |
| <b># LIGHTS:</b> | 3   |

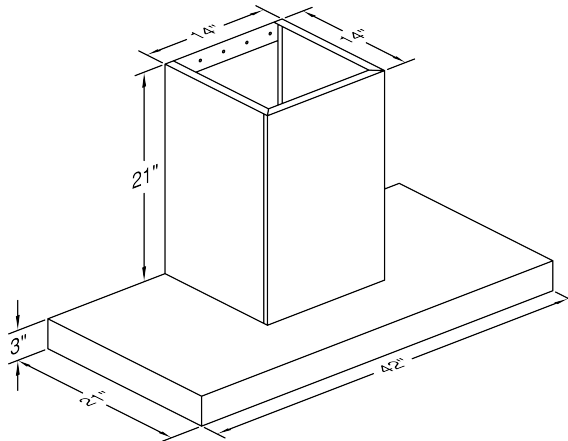

**CONNECTION DIAGRAM**

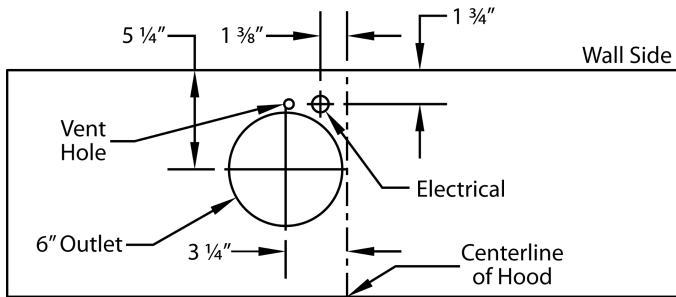

300 CFM B100 Single Blower (Top View)

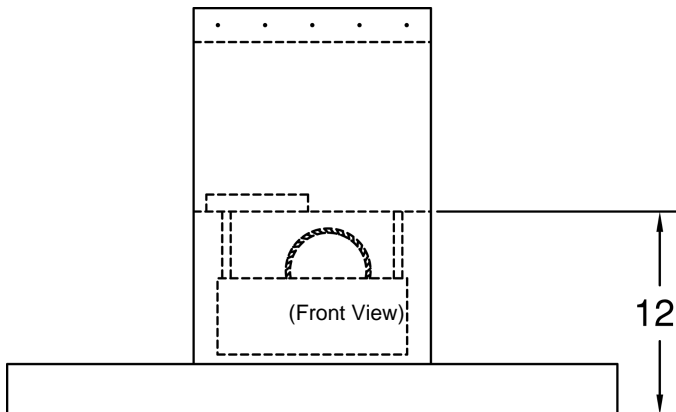

**ELECTRICAL/MECHANICAL SPECIFICATIONS FOR BLOWER UNIT**

| MODEL       | VOLTS | AMPS+ | HZ | RPM  | CFM SP@0.0" | EQUIV CFM\$ | CFM SP@0.1" | CFM SP@0.2" | CFM SP@0.3" | MIN. ROUND DUCT SIZE | SONES# |
|-------------|-------|-------|----|------|-------------|-------------|-------------|-------------|-------------|----------------------|--------|
| B100 Single | 115   | 2.5   | 60 | 1550 | 300         | 450         | 273         | 245         | 225         | 6" (28 sq. in.)      | 5.4    |

+ This model is equipped with LED lighting: (2 lights: 30" - 41", 3 lights: 42" - 53", 4 lights: 54" - 66").

\$ Because the Magic Lung blower uses centrifugal filtration rather than conventional baffle or mesh filters, the Magic Lung blower can handle cooking equipment with higher cubic feet per minute (CFM) requirements and can deliver equivalent CFM much more efficiently than other filtration systems. When comparing the Magic Lung with other blower units made by other manufacturers, use the "Equivalent CFM".

# Ratings in accordance with the Standard Test Code by the Energy Systems Laboratory of the Texas Engineering Experiment Station.

**REC. MOUNTING HEIGHT\***

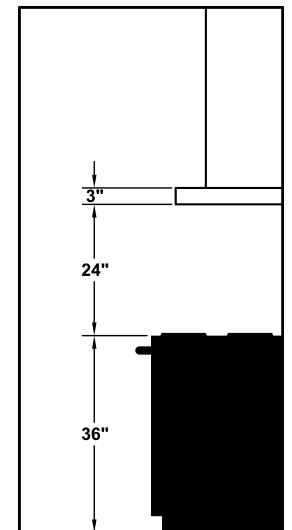

\* Exceeding recommended mounting height may compromise performance.