

Model Number: CWEH9-248

Special Notes: LED lights. WL-1 warming lights are available on selected models. Shown with optional duct cover (sold separately). Optional duct covers are available in standard and custom sizes.

WIDTH:	48"
DEPTH:	21"
HEIGHT:	9"
CFM:	600
SONES:	6.5
AMPS:	4.0
# LIGHTS:	3

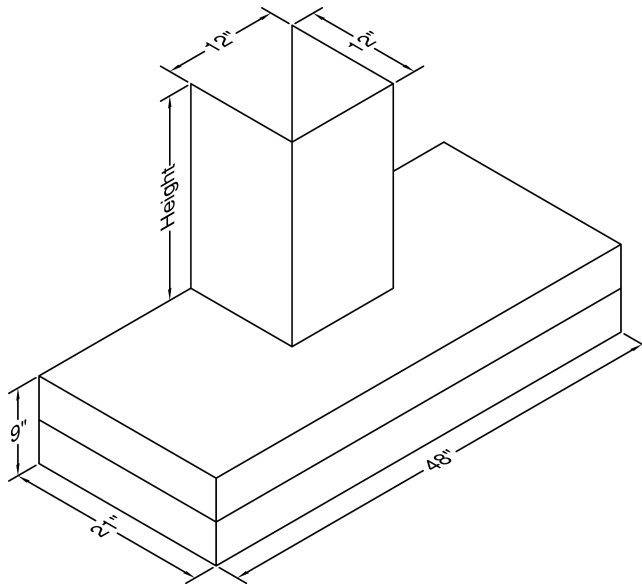

CONNECTION DIAGRAM

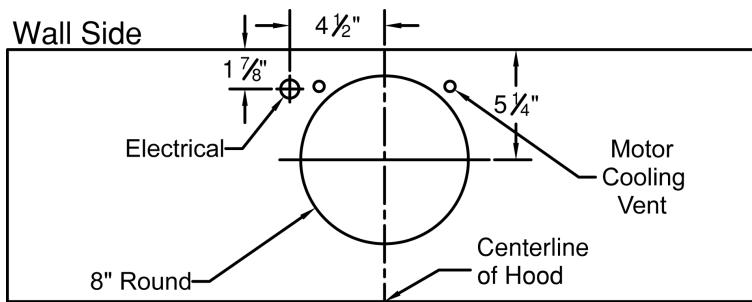

600 CFM B200 Dual Blower (Top View)

REC. MOUNTING HEIGHT*

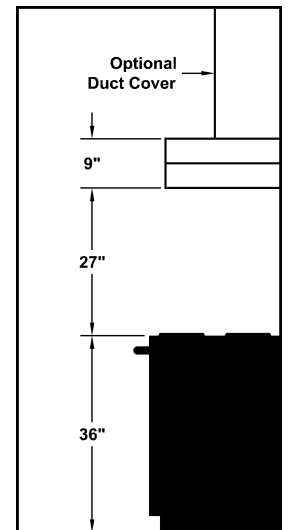

* Exceeding recommended mounting height may compromise performance.

ELECTRICAL/MECHANICAL SPECIFICATIONS FOR BLOWER UNIT

MODEL	VOLTS	AMPS+	HZ	RPM	CFM SP@0.0"	EQUIV CFM\$	CFM SP@0.1"	CFM SP@0.2"	CFM SP@0.3"	MIN. ROUND DUCT SIZE	SONES#
B200 Dual	115	4.0	60	1550	600	900	531	480	430	8" (50 sq. in.)	6.5

+ This model is equipped with LED lighting: (2 lights: 30" - 41", 3 lights: 42" - 53", 4 lights: 54" - 66").

\$ Because the Magic Lung blower uses centrifugal filtration rather than conventional baffle or mesh filters, the Magic Lung blower can handle cooking equipment with higher cubic feet per minute (CFM) requirements and can deliver equivalent CFM much more efficiently than other filtration systems. When comparing the Magic Lung with other blower units made by other manufacturers, use the "Equivalent CFM".

Ratings in accordance with the Standard Test Code by the Energy Systems Laboratory of the Texas Engineering Experiment Station.