

quick start guide



English

1. Safety Information









Safety information

- Before using your new Samsung Side-By-Side Refrigerator, please read this manual thoroughly to ensure that you know how to operate the features and functions that your new appliance offers safely and efficiently.
- This appliance is not intended for use by persons (including children) with reduced physical, sensory, or mental capabilities, or those who lack experience and knowledge, unless they have been given supervision or instruction concerning the use of the appliance by a person responsible for their safety.
- Because the following instructions cover various models, the characteristics of your refrigerator may differ slightly from the refrigerator described in this manual.
- If you have any question, contact us at 1-800-SAMSUNG or find help and information online at www.samsung.com.

Important safety symbols and precautions:

	Hazards or unsafe practices that may result in severe personal injury or death.
	Hazards or unsafe practices that may result in minor personal injury or property damage.

OTHER SYMBOLS USED

	NOTE
	Do NOT attempt.
	Do NOT disassemble.
	Do NOT touch.
	Follow directions carefully.
	Unplug the power plug from the wall socket.
	Make sure the machine is grounded to prevent electric shock.
	Call the contact center for help.

**These warning signs are here to prevent injury to you and others.
Please follow them carefully.
After reading this section, keep it in a safe place for future reference.**

CRITICAL INSTALLATION WARNINGS

- ⊘ • Do not install the refrigerator in a damp location or place where it may come in contact with water.
 - Deteriorated insulation on electrical parts may cause an electric shock or fire.
 - Do not place this refrigerator in direct sunlight or expose it to the heat from stoves, room heaters, or other appliances.
 - Do not plug several appliances into the same multiple power strip.
The refrigerator should always be plugged into its own individual electrical outlet which has a voltage rating that matches the voltage listed on the refrigerator's rating plate.
 - This provides the best performance and also prevents overloading of house wiring circuits, which could cause a fire hazard from overheated wires.
 - If the wall socket is loose, do not insert the power plug.
 - There is a risk of electric shock or fire.
 - Do not use a power cord that has cracks or abrasion damage along its length or at either end.
 - Do not bend the power cord excessively or place heavy objects on it.
 - Do not twist or tie the power cord.
 - Do not hook the power cord over a metal object, place a heavy object on the power cord, insert the power cord between objects, or push the power cord into the space behind the appliance.
 - When moving the refrigerator, be careful not to roll over or damage the power cord.
 - This may result in an electric shock or fire.
 - Never unplug your refrigerator by pulling on the power cord.
Always grip the plug firmly and pull straight out from the outlet.
 - Damage to the cord may cause a short-circuit, fire, and/or electric shock.
 - Do not use aerosols near the refrigerator.
 - Using aerosols near the refrigerator may cause an explosion or fire.
 - Do not install this appliance near a heater or inflammable material.
 - Do not install this appliance in a humid, oily, or dusty location, or in a location exposed to direct sunlight or water (rain, etc.).
 - Do not install this appliance in a location where gas may leak.
 - This may result in an electric shock or fire.
-

- ★ • This refrigerator must be properly located and installed in accordance with the instructions in this manual before you use it.
 - Connect the power plug in the proper position with the cord hanging down.
 - If you connect the power plug upside down, the wire can get cut off and cause a fire or electric shock.
 - When moving the refrigerator, be careful not to roll over or damage the power cord.
 - This constitutes a fire hazard.
 - Make sure that the power plug is not crushed or damaged by the back of the refrigerator.
 - Keep the packing materials out of reach of children.
 - There is a risk of death from suffocation if a child puts the packing materials on his or her head.
 - The appliance must be positioned so that the plug is accessible after installation.
 - Failing to do so may result in an electric shock or fire due to electric leakage.
 - You need to remove all the protective plastic film before you initially plug the product in.
-



- The refrigerator must be safely grounded.
 - Always make sure that you have grounded the refrigerator before attempting to investigate or repair any part of the appliance.
Power leakages can cause severe electric shock.
 - Never use gas pipes, telephone lines, or other potential lightning attractors as an electrical ground.
 - Improper use of the grounding plug can result in a risk of electric shock.
If it is necessary to use an extension cord, use only a 3-wire extension cord that has a 3-blade grounding plug and a 3-slot receptacle that will accept the plug on the appliance.
The marked rating of the extension cord should be AC 115-120 V, 10 A, or more.
If a grounding adapter is used, make sure the receptacle box is fully grounded.
 - Plug the power plug into the wall socket firmly. Do not use a damaged power plug, damaged power cord, or loose wall socket.
 - This may result in an electric shock or fire.
-



- If the power cord is damaged, have it replaced immediately by the manufacturer or one of its service agents.

INSTALLATION CAUTIONS



- Allow sufficient space around the refrigerator and install it on a flat surface.
 - If your refrigerator is not level, the internal cooling system may not work correctly.
 - Keep the ventilation space in the appliance enclosure or mounting structure clear of obstructions.
- Allow the appliance to stand for 2 hours after installation.
- We strongly recommend you have a qualified technician or service company install the refrigerator.
 - Failing to do so may result in an electric shock, fire, explosion, problems with the product, or injury.

CRITICAL USAGE WARNINGS



- Do not insert the power plug into a wall socket with wet hands.
- Do not store articles on the top of the appliance.
 - When you open or close the door, the articles may fall and cause personal injury and/or material damage.
- Do not insert hands, feet or metal objects (such as knives, etc.) into the bottom or the back of the refrigerator.
 - This may result in an electric shock or injury.
 - Any sharp edges may cause a personal injury
- Do not put a container filled with water on the refrigerator.
- If spilled, there is a risk of fire or electric shock.
- Children should be supervised to ensure that they do not play with the appliance.
 - Keep fingers out of "pinch point" areas. Clearances between the doors and cabinet are necessarily small. Be careful when you open the doors if children are in the area.
- Do not let children hang on the door.
A serious injury may occur.
- Do not let children go inside the refrigerator. They could become trapped.
- Do not insert your hands into the bottom area under the appliance.
 - Any sharp edges may cause personal injury.
- Do not let children step on a drawer cover.
 - The drawer may break and cause them to slip.

- Do not overfill the refrigerator with food.
 - When you open the door, an item may fall out and cause personal injury or material damage.
- Do not touch the inside walls of the freezer or products stored in the freezer with wet hands.
 - This may cause frostbite.
- Never put fingers or other objects into the water dispenser hole, ice chute, or ice maker bucket.
 - It may cause personal injury or material damage.
- Do not use or place any substances sensitive to temperature such as inflammable sprays, inflammable objects, dry ice, medicine, or chemicals near or inside of the refrigerator.
- Do not keep volatile or inflammable objects or substances (benzene, thinner, propane gas, alcohol, ether, LP gas, and other such products) in the refrigerator.
 - This refrigerator is for storing food only.
 - This may result in fire or explosion.
- Do not store pharmaceutical products, scientific materials, or temperature sensitive products in the refrigerator.
 - Products that require strict temperature controls must not be stored in the refrigerator.
- Do not place or use an electrical appliance inside the refrigerator, unless it is of a type recommended by the manufacturer.
- Do not stand on top of the appliance or place objects (such as laundry, lighted candles, lighted cigarettes, dishes, chemicals, metal objects, etc.) on the appliance.

This may result in an electric shock, fire, problems with the product, or injury.
Do not put a container filled with water on the appliance.

 - If spilled, there is a risk of fire or electric shock.
- Do not use mechanical devices or any other means to accelerate the defrosting process, other than those recommended by the manufacturer.
- Do not damage the refrigerant circuit.
- Do not spray volatile material such as insecticide onto the surface of the appliance.
 - As well as being harmful to humans, it may also result in an electric shock, fire, or problems with the product.
- Never stare directly at the UV LED lamp for long periods of time.
 - This may result in eye strain due to the ultraviolet rays.



- Do not attempt to repair, disassemble, or modify the appliance yourself.
- Do not use any fuse (such as cooper, steel wire, etc.) other than a standard fuse.
- If your appliance needs to be repaired or reinstalled, contact your nearest service center.
 - Failing to do so may result in an electric shock, fire, problems with the product, or injury.
- If the interior or exterior LED lamp has gone out, please contact your nearest service center.



- Children should be supervised to ensure that they do not play with the appliance.
 - Keep fingers out of “pinch point” areas. : Clearances between the doors and cabinet are necessarily small. Be careful when you open the doors if children are in the area.
 - Do not let children hang on the door.

A serious injury may occur.
 - Do not let children go inside the refrigerator. They could become trapped.
 - Bottles should be stored tightly together so that they do not fall out.
 - This product is intended only for the storage of food in a domestic environment.
 - If a gas leak is detected, avoid any naked flames or potential sources of ignition, and air the room in which the appliance is standing for several minutes.
 - Do not touch the appliance or power cord.
 - Do not use a ventilating fan.
 - A spark may result in explosion or fire.
 - Use only the LED Lamps provided by the manufacturer or its service agents.
-

- If the refrigerator emits a burning smell or smoke, unplug the refrigerator immediately and contact your Samsung Electronics service center.
- If you experience difficulty changing a non-LED light, contact a Samsung service center.
- If the product is equipped with LED Lamps, do not disassemble the Lamp Covers and LED Lamps yourself.
 - Please contact your service agents.
- If dust or water enters the refrigerator, unplug the refrigerator and contact your Samsung Electronics service center.
 - There is a risk of fire.

USAGE CAUTIONS

- Do not re-freeze frozen foods that have thawed completely.
Do not place carbonated or fizzy drinks in the freezer compartment.
Do not put bottles or glass containers in the freezer.
 - When the contents freeze, the glass may break and cause personal injury.
- Use only the ice maker provided with the refrigerator.
- Have the refrigerator's water supply installed by a suitably qualified person and connected only to a potable water supply.
To operate the ice maker properly, water pressure of 20 ~ 125 psi (138 ~ 862 kPa) is required.
If you will be away from home for a long period of time (on vacation, for example) and won't be using the water or ice dispensers, close the water valve.
 - Otherwise, water leakage may occur.
- If you won't be using the refrigerator for a very long period of time, (3 weeks or more) empty the refrigerator, unplug it, close the water valve, wipe excess moisture from the inside walls, and leave the doors open to prevent odors and mold.

- Service Warranty and Modification.
- Any changes or modifications performed by a 3rd party on this finished appliance are not covered under Samsung warranty service, nor is Samsung responsible for safety issues that result from 3rd party modifications.
- Do not block the air vents inside the refrigerator.
 - If the air vents are blocked, especially with a plastic bag, the refrigerator can be over cooled. If this cooling period lasts too long, the water filter may break and cause water leakage.
- If the refrigerator is disconnected from the power supply, you should wait for at least five minutes before plugging it back in.
- If you have a long vacation planned or do not intend to use the refrigerator for a long period of time, (3 weeks or more) empty the refrigerator, pull out the power plug, close the water valve, wipe excess moisture from the inside walls, and leave the doors open to prevent odors and mold.
 - Letting the refrigerator run long periods of time without using it can cause the insulation to deteriorate and may cause a fire.
- To get the best performance from the product:
 - Do not place food too close to the vents at the rear of the appliance as it can obstruct free air circulation in the refrigerator compartment.
 - Wrap food up properly or place it in airtight containers before putting it into the refrigerator.
 - Do not place glass bottles or carbonated beverages into the freezer.
They can freeze and break.
Broken beverage containers can cause injury.
 - Please observe maximum storage times and expiration dates of frozen goods.
 - There is no need to disconnect the refrigerator from the power supply if you will be away for less than three weeks. However, if you will be away for more than three weeks, remove all the food, unplug the refrigerator, close the water valve, wipe excess moisture from the inside walls, and leave the doors open to prevent odors and mold.
- Fill the water tank and ice cube trays with potable water only (tap water, mineral water, or purified water).
 - Do not fill the tank with tea or a Sports drink. This may damage the refrigerator.
 - Do not strike or apply excessive force to any glass surface.
 - Broken glass may result in a personal injury and/or property damage.

- If the product is flooded, make sure to contact your nearest service center.
 - There is a risk of electric shock or fire.

CLEANING CAUTIONS



- Do not spray water directly on the inside or outside the refrigerator.
 - There is a risk of fire or electric shock.
 - Do not use a hair dryer to dry the inside of the refrigerator.
 - Do not place a lighted candle in the refrigerator to remove bad odors.
 - This may result in an electric shock or fire.
-



- Use a clean, dry cloth to remove any foreign matter or dust from the power plug blades. Do not use a wet or damp cloth when cleaning the plug.
 - Otherwise, there is a risk of fire or electric shock.
-



- Before cleaning or performing maintenance, unplug the appliance from the wall socket.
 - Failing to do so may result in an electric shock or fire.



- This product contains chemicals known to the State of California to cause cancer and reproductive toxicity.

CRITICAL DISPOSAL WARNINGS



- DANGER : Risk of child entrapment.
Before you throw away your old refrigerator or freezer:
 - Take off the doors and door latch.
 - Leave the shelves in place so that children cannot easily climb inside.
 - Children trapped inside a refrigerator can hurt themselves or suffocate to death.
- Please dispose of the packaging material from this product in an environmentally friendly manner.
- Ensure that none of the pipes on the back of the appliance are damaged prior to disposal.
- R-600a or R-134a is used as a refrigerant. Check the compressor label on the rear of the appliance or the rating label inside the fridge to see which refrigerant is used for your refrigerator.
If this product contains flammable gas (Refrigerant R-600a), contact your local authority in regard to safe disposal of this product.
- When disposing of this refrigerator, remove the door/door seals and door latch so that small children or animals cannot become trapped inside.
Children should be supervised to ensure that they do not play with the appliance.
If trapped inside, the child may get hurt or suffocate to death.
- Cyclopentane is used in the insulation.
The gases in the insulation material require a special disposal procedure.
Please contact your local authorities in regard to the environmentally safe disposal of this product.
- Keep all packaging materials well out of the reach of children, as packaging materials can be dangerous to children.
 - If a child places a bag over his or her head, the child could suffocate.

ADDITIONAL TIPS FOR PROPER USAGE



- In the event of a power failure, call the local office of your Electricity Company and ask how long it is going to last.
 - Most power failures that are corrected in an hour or two will not affect your refrigerator temperatures. However, you should minimize the number of door openings while the power is off.
 - Should the power failure last more than 24 hours, remove and discard all frozen food.
- If a key is provided with refrigerator, the keys should be kept out of the reach of children and not be kept in the vicinity of the appliance.
- The appliance might not operate consistently (frozen contents can thaw or temperatures can become too warm in the frozen food compartment) when sited for an extended period of time in a location where ambient air temperatures are constantly below the temperatures for which the appliance is designed.
- Do not store food which goes bad easily at low temperature, such as bananas and melons.
- Your appliance is frost free, which means there is no need to manually defrost your appliance. This will be carried out automatically.
- Temperature rise during defrosting complies with ISO requirements.
But If you want to prevent an undue rise in the temperature of frozen food while the appliance defrosts, wrap the frozen food in several layers of newspaper.
- Any increase in the temperature of frozen food during defrosting can shorten its storage life.
- Do not re-freeze frozen foods that have thawed completely.

2. Setting up

Getting ready to install the refrigerator

Congratulations on your purchase of this Samsung French Door Refrigerator.

We hope you enjoy the state-of-art features and efficiencies that this new appliance offers.

Selecting the best location for the refrigerator

Choose :

- A location with easy access to a water supply.
- A location without direct exposure to sunlight.
- A location with level (or nearly level) flooring.
- A location with enough space for the refrigerator doors to open easily.
- A location that allows sufficient space to the right, left, back, and top for air circulation.
If the refrigerator does not have enough space, it can cause the bad influence to refrigeration efficiency and power consumption.
- A location that allows you to move the refrigerator easily if it needs maintenance or service.
- Do not install the refrigerator in locations where the temperature is over 110 °F (43 °C) or below 50 °F (10 °C).

If your refrigerator is not level, the internal cooling system may not work correctly.

Refer to drawing and dimensions below for overall space required for use.

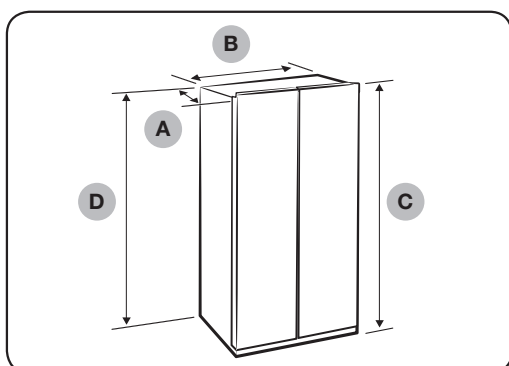

Depth	"A"	36 1/5" (919 mm)
Width	"B"	35 3/4" (908 mm)
Height	"C"	68 3/5" (1742.5 mm)
Overall Height	"D"	69 9/10" (1776 mm)

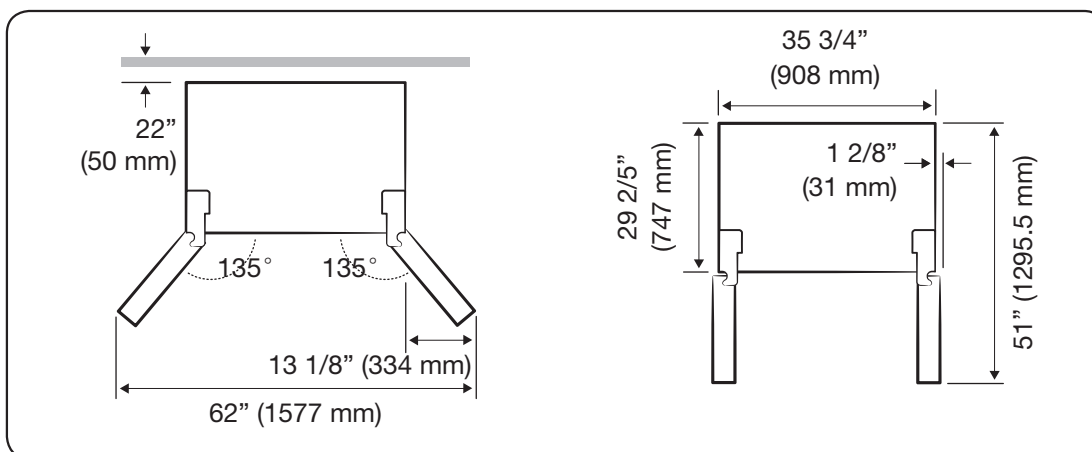

Each measurement based on the design dimension, so it may differ depending on the measuring method.



FLOORING

For proper installation, you must place this refrigerator on a level, hard surface that is the same height as the rest of the floor.

This surface should be strong enough to support a fully loaded refrigerator. To protect the finish of the flooring during installation, cut a large section of the cardboard carton and place it under the refrigerator where you are working.

When moving the refrigerator, you need to pull and push it straight forwards or back.

Do not wiggle it from side to side.



- When installing, servicing or cleaning behind the refrigerator, be sure to pull the unit straight out and push back in straight after finishing.

3. Names and basic functions

STORING FOOD

The Samsung Side-By-Side Refrigerator has been designed to provide you with maximum space saving features and functions.

Here are some of the customized compartments we have created to keep your food fresher, longer.

Important : To prevent odors from penetrating the ice in the ice maker, store all food securely in wraps or containers that are as airtight as possible.

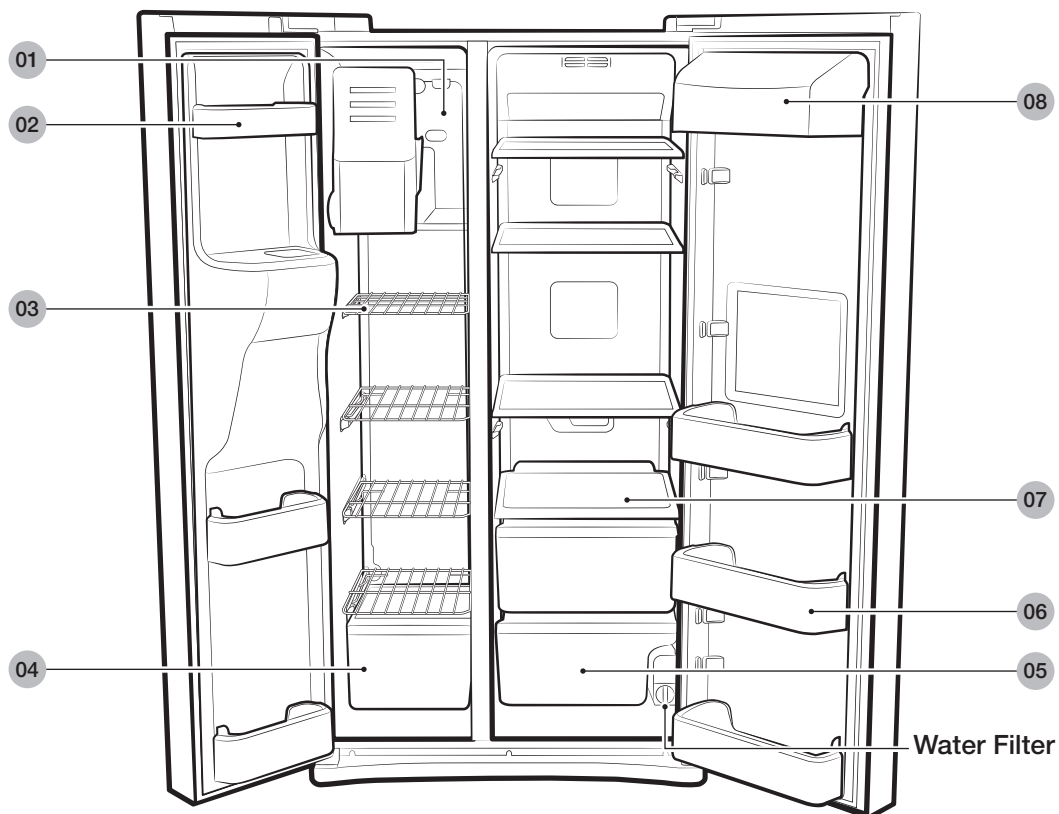

Because the following operating instructions cover various models, the instructions for your refrigerator may differ slightly from the instructions in this manual.

4. Operating the SAMSUNG side-by-side refrigerator

CHECKING THE CONTROL PANEL

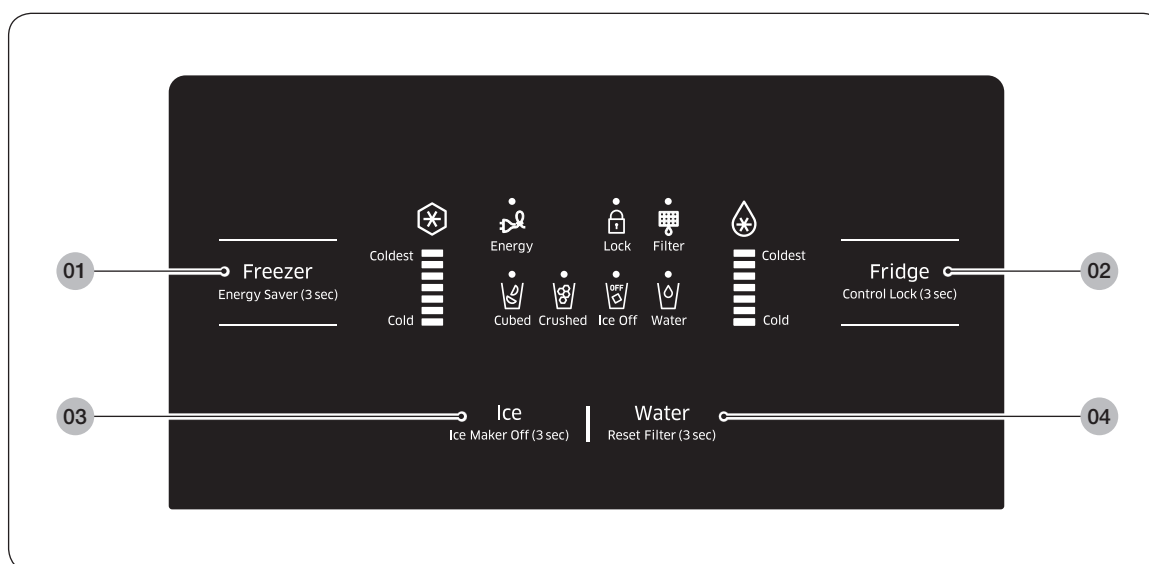

<p>01 Freezer / Energy Saver (3 sec)</p>	<p>Press the Freezer button to set the freezer temperature between cold and coldest. Press Freezer button for several times to activate the Power Freeze icon which speeds up the freezing process in the freezer. This can be helpful if you need to quickly freeze items that spoil easily or if the temperature in the freezer has warmed dramatically (For example, if the door was left open). If you need to freeze a large amount of food, activate the Power Freeze function at least 20 hours before you put the food into the freezer. Press and hold the Freezer button for 3 seconds to activate the Energy Saver function for better energy efficiency. If condensation occurs on the doors, turn the Energy Saver function off.</p>
<p>02 Fridge / Control Lock (3 sec)</p>	<p>Press the Fridge button to set the Fridge temperature between cold and coldest. Press and hold the Fridge button for several times to activate the Power Cool function which speeds up the cooling process in the refrigerator. If you press and hold the Fridge button for 3 seconds, all buttons will be locked and the dispenser pad will not work.</p>
<p>03 Ice / Ice Maker Off (3 sec)</p>	<p>Press the Ice button to select cubed ice or crushed ice. Press and hold the Ice button for 3 seconds to turn the ice making function off. Press and hold the Ice button again for 3 seconds to turn the ice making function back on.</p>
<p>04 Water / Reset Filter (3 sec)</p>	<p>Press the Water button to turn the water dispenser on. Press and hold the Water button for 3 seconds after changing the filter to reset the water filter indicator.</p>

 To deactivate the secondary functions (such as Ice Off and Control Lock), press and hold the corresponding button again for 3 seconds.

5. Troubleshooting

PROBLEM	SOLUTION
<p>The refrigerator does not work at all or it does not chill sufficiently.</p>	<ul style="list-style-type: none"> • Confirm that the power plug is properly connected. • Is the temperature control on the display panel set to the correct temperature? Try setting it to a lower temperature. • Is the refrigerator in direct sunlight or located too near a heat source? • Is the back of the refrigerator too close to the wall and therefore keeping air from circulating? • Check if the Cooling Off function is on. If the Freezer/Fridge temperature indicator is moving, refer to page <?> to cancel the Cooling Off function.
<p>The food in the fridge is frozen.</p>	<ul style="list-style-type: none"> • Is the temperature control on the display panel set to the correct temperature? Try setting it to a warmer temperature. • Is the temperature in the room very low? • Did you store the food with a high water content in the coldest part of the fridge?
<p>You hear unusual noise or sounds.</p>	<ul style="list-style-type: none"> • Confirm that the refrigerator is level and stable. • If the refrigerator's water supply line is not connected and water is not being supplied to the refrigerator, the refrigerator will make unusual noises if the ice maker is on or if you push the water dispenser lever. To stop the noises, press the Ice button for at least 3 seconds until the Ice Off icon lights indicating that the ice maker is off. • You hear a ticking sound from inside the refrigerator. This is normal and occurs because various parts in the refrigerator's interior contract or expand in response to temperature changes.
<p>The front corners of the appliance are hot and condensation is occurring.</p>	<ul style="list-style-type: none"> • Some heat is normal as anti-condensators are installed in the front corners of the refrigerator to prevent condensation. • Is the refrigerator door ajar? Condensation can occur when you leave the door open for a long time.
<p>Ice is not dispensing.</p>	<ul style="list-style-type: none"> • Did you wait for 12 hours after installation of the water supply line before making ice? • Is the water line connected and the shut-off valve open? • Did you manually stop the ice making function? Make sure Ice Type is set to Cubed or Crushed. • Is there any ice clumped in the ice maker bucket? • Is the freezer temperature too warm? Try setting the freezer temperature lower.
<p>You can hear water bubbling in the refrigerator.</p>	<ul style="list-style-type: none"> • This is normal. The bubbling comes from the refrigerant coolant liquid circulating through the refrigerator.
<p>There is a bad smell in the refrigerator.</p>	<ul style="list-style-type: none"> • Has a food item spoiled? • Make sure that strong smelling food (for example, fish) is wrapped so that it is airtight. • Clean out your freezer periodically and throw away any spoiled or suspect food.
<p>Frost forms on the walls of the freezer.</p>	<ul style="list-style-type: none"> • Is the air vent blocked? Remove any obstructions so air can circulate freely. • Allow sufficient space between the foods stored for efficient air circulation. • Is the freezer door closed properly?
<p>Water dispenser is not functioning.</p>	<ul style="list-style-type: none"> • Is the water line connected and the shut-off valve open? • Has the water supply line tubing been crushed or kinked? Make sure the tubing is free and clear of any obstruction. • Is the water tank frozen because the refrigerator temperature is too low? Try selecting a warmer setting on the main display panel.