



RF18**

RF20**

Refrigerator user manual

Planet
First

100 %
Recycled Paper

This manual is made with 100% recycled paper.

English

imagine the possibilities

Thank you for purchasing this Samsung product.

To receive more complete service,
please register your product at

www.samsung.com/register

Free Standing Appliance

条形码

DA68-01845C-15

SAMSUNG

Features of your new Refrigerator

KEY FEATURES OF YOUR NEW REFRIGERATOR

Your Samsung Refrigerator comes equipped with various innovative storage and energy-efficient features.

- **Twin Cooling System**

The Refrigerator and Freezer have separate evaporators. Due to this independent cooling system, the Freezer and Refrigerator cool more efficiently.

Additionally, this separate air flow system prevents food odor of one compartment from seeping into other compartments.

- **Bigger & Wider Space**

The wide shelf area provides enough space for larger items.

The wide freezer drawer also provides enough space for 2-3 turkeys.

- **Secure Auto Close**

The Secure Auto Close feature will automatically close a door that is slightly open.

- **Digital Display and Temperature Control**

The easy-to-read Digital Display enhances the look of your kitchen and allows you precise temperature control.

- **Door Alarm**

A helpful beeper alerts you if a door is ajar.

- **Easy Handle**

Freezer door can be opened with less effort.

- **Inverter compressor (RF18*RF20*)**

Its imported high effective inverter compressor reduces power consumption of the refrigerator, lowers noise while operation, operates different states at different frequency, and is advantageous in freezing capacity and cooling speed.



For easy future reference, write the model and serial number down. You will find your model number and serial number on the left side of the refrigerator.

Model # _____

Serial # _____



Safety Information

SAFETY INFORMATION











Before operating the appliance, please read this manual thoroughly and retain it for your reference. Use this appliance only for its intended purpose as described in this instruction manual.

This appliance is not intended for use by persons (including children) with reduced physical, sensory or mental capabilities, or lack of experience and knowledge, unless they have been given supervision or instruction concerning use of the appliance by a person responsible for their safety.

This appliance is not intended for use by persons (including children) with reduced physical, sensory or mental capabilities, or lack of experience and knowledge, unless they have been given supervision or instruction concerning use of the appliance by a person responsible for their safety.

Because the following instruction covers various models, the characteristics of your Refrigerator may differ slightly from the Refrigerator described in this manual. If you have any question, contact us at 1-800-SAMSUNG or find help and information online at www.samsung.com.

Important safety symbols and precautions:

 WARNING	Hazards or unsafe practices that may result in severe personal injury or death .
 CAUTION	Hazards or unsafe practices that may result in minor personal injury or property damage .
	Do NOT attempt.
	Do NOT disassemble.
	Do NOT touch.
	Follow directions carefully.
	Unplug the power plug from the wall socket.
	Make sure the machine is grounded to prevent electric shock.
	Call the contact center for help.
	Note.

These warning signs are here to prevent injury to you and others.

Please follow them carefully.

After reading this section, keep it in a safe place for future reference.



SEVERE WARNING SIGNS FOR INSTALLATION

-  • Do not install the refrigerator in a damp place or place where it may come in contact with water.
 - Deteriorated insulation of electrical parts may cause an electric shock or fire.
- Do not place this refrigerator in direct sunlight or expose to the heat from stoves, room heaters or other appliance.



Safety Information

- **Do not plug several appliances into the same multiple power board. The refrigerator should always be plugged into its own individual electrical which has a voltage rating that matched the rating plate.**
 - This provides the best performance and also prevents overloading house wiring circuits, which could cause a fire hazard from overheated wires.
- **If the wall socket is loose, do not insert the power plug.**
 - There is a risk of electric shock of fire.
- **Do not use a cord that shows cracks or abrasion damage along its length or at either end.**
- **Do not bend the power cord excessively or place heavy articles on it.**
- **Never unplug your refrigerator by pulling on the power cord. Always grip plug firmly and pull straight out from the outlet.**
 - Damage to the cord may cause a short-circuit, fire and/or electric shock.
- **Do not use aerosols near the Refrigerator.**
 - Aerosols used near the Refrigerator may cause an explosion or fire.



- **This refrigerator must be properly installed and located in accordance with the manual before it is used.**
- **Connect the power plug in proper position with the cord hanging down.**
 - If you connect the power plug upside down, the wire can get cut off and cause a fire or electric shock.
- **When moving the refrigerator, be careful not to roll over or damage the power cord.**
 - This constitutes a fire hazard.
- **Make sure that the power plug is not squashed or damaged by the back of the refrigerator.**
- **Keep the packing materials out of reach of children.**
 - There is a risk of death from suffocation if children put them on their head.
- **The appliance must be positioned so that the plug is accessible after installation.**



- **The Refrigerator must be safely grounded**
 - Always make sure that you have grounded the Refrigerator before attempting to investigate or repair any part of the appliance. Power leakages can cause severe electric shock.
- **Never use gas pipes, telephone lines or other potential lightning attractors as an electrical ground.**

WARNING

- Improper use of the grounding plug can result in a risk of electric shock.

If it is necessary to use an extension cord, use only a 3-wire extension cord that has a 3-blade grounding plug and a 3-slot receptacle that will accept the plug on the appliance. The marked rating of the extension cord should be AC115-120 V, 10 A, or more. If a grounding adapter is used, make sure the receptacle box is fully ground

Note: GFI (ground fault interrupter) is not recommended.



- **If the power cord is damaged, have it replaced immediately by the manufacturer or its service agent.**



CAUTION SIGNS FOR INSTALLATION

- ★ • **Allow sufficient space to install the refrigerator on a flat surface.**
 - If your refrigerator is not level, the internal cooling system may not work correctly.
- **Keep ventilation opening in the appliance enclosure or mounting structure clear of obstruction.**
- **Allow the appliance to stand for 2 hours after installation.**



WARNING SEVERE WARNING SIGNS FOR USING

- ☒ • **Do not insert the power plug with wet hands.**
- **Do not store articles on the top of the appliance.**
 - When you open or close the door, the articles may fall and cause personal injury and/or material damage.
- **Do not put a container filled with water on the refrigerator.**
 - If spilled, there is a risk of fire or electric shock.
- **Children should be supervised to ensure that they do not play with the appliance.**
 - Keep fingers out of "pinch point" areas : clearances between the doors and cabinet are necessarily small. Be careful when you open the doors when children are in the area.
- **Do not let children hang on the door. A serious injury may occur.**
- **Do not let children enter inside of the refrigerator. There is a risk of children entrapment.**
- **Do not insert your hands into the bottom area under the appliance.**
 - Any sharp edges may cause personal injury.
- **Do not let children step on drawer's cover.**
 - The drawer may break and cause them to slip.
- **Do not overfill the refrigerator with food.**
 - When you open the door, an item may fall out and cause personal injury or material damage.
- **Do not touch the inside walls of the freezer or products stored in the freezer with wet hands.**
 - This may cause frostbite.
- **Do not spray inflammable gas near the refrigerator.**
 - There is a risk of explosion or fire.
- **Do not store volatile or flammable substances in the refrigerator.**
 - The storage of benzene, thinner, alcohol, ether, LP gas and other such products may cause explosions.
- **Do not store pharmaceuticals products, scientific materials or temperature sensitive products in the refrigerator.**
 - Products that require strict temperature controls must not be stored in the refrigerator.
- **Do not place or use an electrical appliance inside the refrigerator, unless it is of a type recommended by the manufacturer.**
- **Do not use mechanical devices or any other means to accelerate the defrosting process, other than those recommended by the manufacturer.**
- **Do not damage the refrigerant circuit.**



- **Do not disassemble or repair the refrigerator by yourself.**
 - You run risk of causing a fire, malfunction and/or personal injury.
-



Safety Information



WARNING SEVERE WARNING SIGNS FOR USING

- ★ • Children should be supervised to ensure that they do not play with the appliance.
 - Bottles should be stored tightly together so that they do not fall out.
 - This product is intended only for the storage of food in a domestic environment.
 - If a gas leak is detected, avoid any naked flames or potential sources of ignition and air the room in which the appliance is standing for several minutes.
-
- 🔌 • Pull the power plug out of the socket before changing the interior lamps of the refrigerator.
 - Otherwise, there is a risk of electric shock.
-
- 🔧 • If the appliance generates a strange noise, a burning smell or smoke, unplug the power plug immediately and contact your nearest service center.
 - If you experience difficulty when changing the light, contact service agents.
 - If any dust or water is in Refrigerator, pull out power plug and contact your Samsung Electronics service center.
 - Otherwise there is a risk of fire



CAUTION CAUTION SIGNS FOR USING

- ☒ • Do not re-freeze frozen foods that have thawed completely.
 - Do not place carbonated or fizzy drinks in the freezer compartment. Do not put bottles or glass containers in the freezer.
 - When the contents freeze, the glass may break and cause personal injury.
-
- ★ • **Service warranty and Modification.**
 - Any changes or modifications performed by a 3rd party on this finished appliance is not covered under Samsung warranty service, nor can Samsung be responsible for safety issues that result from 3rd party modifications.
 - **Do not block air holes.**
 - If the air holes are blocked, especially with a plastic bag, the refrigerator can be over cooled. If this cooling period lasts too long, the water filter may break and cause water leakage.
 - **If the refrigerator is disconnected from the power supply, you should wait for at least five minutes before plugging it back.**
 - **If you have a long vacation planned or the refrigerator is not to be used for a long period of time, you must empty the refrigerator and pull out the power plug.**
 - Deterioration in the insulation may cause fire.
 - **Wipe excess moisture from the inside and leave the doors open.**
 - Otherwise, door and mold may develop.
 - **To get Best performance of product,**
 - Do not place foods too closely in front of the vents at the rear of the appliance as it can obstruct free air circulation in the refrigerator compartment.
 - Wrap the food up properly or place it in airtight containers before putting it into the refrigerator.
 - **Fill water tank, ice tray, water cubes only with potable water.**
 - **Do not apply strong shock or excessive force onto the surface of glass.**
 - Broken glass may result in a personal injury and/or property damage.



CAUTION CAUTION SIGNS FOR USING



- When the product is flooded, make sure to contact your nearest service center.
- There is a risk of electric shock or fire.
-



- Do not directly spray water inside or outside the refrigerator.
- There is a risk of fire or electric shock.
-



- Remove any foreign matter or dust from the power plug pins. Do not use a wet or damp cloth when cleaning the plug, remove any foreign material or dust from the power plug pins.
- Otherwise there is a risk of fire or electric shock.
-



- Unplug the refrigerator before cleaning and making repairs.
-



WARNING SEVERE WARNING SIGNS FOR DISPOSAL



- ★ **DANGER : Risk of child entrapment. Before you throw away your old refrigerator or freezer:**
 - Take off the doors.
 - Leave the shelves in place so that children may not easily climb inside.
- Please dispose of the packaging material for this product in an environmentally friendly manner.
- Leave the shelves in place so that children may not easily climb inside. Ensure that none of the pipes on the back of the appliance are damaged prior to disposal.
- When disposing of this refrigerator, remove the door/door seals and door latch so that small children or animals cannot become trapped inside.
Children should be supervised to ensure that they do not play with the appliance.
- Cyclopentane is used as in the insulation. The gases in the insulation material require a special disposal procedure. Please contact your local authorities in regard to the environmentally safe disposal of this product. Ensure that none of the pipes on the back of the refrigerator are damaged prior to disposal.



WARNING

This product contains chemicals known to the State of California to cause cancer and reproductive toxicity.



There is protective film on the surface of some refrigerator models, which is used to protect the refrigerator from scratches during transport. To avoid static electricity, please peel off the protective film slowly. If the protective film is not removed for a long time, it may cause color shading of the steel plate.

Contents

SETTING UP YOUR FRENCH DOOR REFRIGERATOR

09

- 09 Getting ready to install the refrigerator
- 10 Setting up the refrigerator
- 10 Removing the refrigerator doors
- 15 Adjusting the doors
- 16 Making minor adjustments between doors
- 17 Installation of the water line

OPERATING YOUR SAMSUNG REFRIGERATOR

19

- 19 Parts and features
- 20 Using the control panel
- 21 Controlling the temperature
- 24 Storing food in the refrigerator
- 24 Storing food in the freezer drawer
- 25 Food storage tips
- 27 Removing the fridge accessories
- 28 Removing the freezer accessories
- 29 Cleaning the refrigerator
- 30 Changing the interior light

TROUBLESHOOTING

31

- 31 Troubleshooting

WARRANTY

32

- 32 Warranty

Setting up your French Door Refrigerator

GETTING READY TO INSTALL THE REFRIGERATOR

Congratulations on your purchase of this Samsung French Door Refrigerator. We hope you enjoy the state-of-art features and efficiencies that this new appliance offers.

Selecting the best location for the Refrigerator

- A location with easy access to the water supply.
- A location without direct exposure to sunlight.
- A location with level (or nearly level) flooring.
- A location with enough space for the Refrigerator doors to open easily.
- Allow sufficient space to the right, left, back and top for air circulation.
- Please ensure that appliance can be moved freely in the event of maintenance & service.
- If you install the Refrigerator where is below 50°F (10°C), it may not function optimally.
- Do not locate the refrigerator where the wet condition.

First thing! Make sure that you can easily move your Refrigerator to its final location by measuring doorways (both width and height), thresholds, ceilings, stairways, etc.

The following chart details the exact height and depth of Samsung French Door Refrigerator.

Model		RF18**	RF20**	
Dimension (inch/mm)	Width (A)	32 1/8(817)		
	Depth	without door (B)	24 1/4(617)	26 1/4(667)
		with door (C)	30 4/8(775)	32 4/8(825)
	Height	without hinge (D)	70 1/8(1780)	70 1/8(1780)
		with hinge (E)	70 1/8(1780)	70 1/8(1780)
total		70 6/8(1798)	70 6/8(1798)	

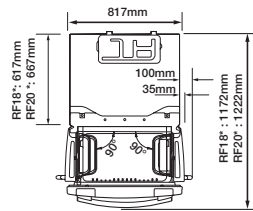
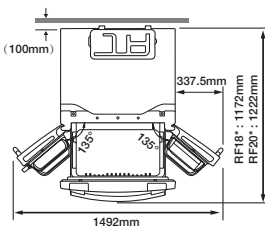
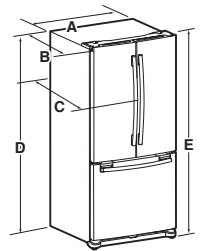

- The measurements here are based on the design dimension, which may differ depending on the measuring method.



When moving your refrigerator

To prevent floor damage, be sure the front adjusting legs are in the up position (above the floor). Refer to 'Adjusting the doors' (on page 15).

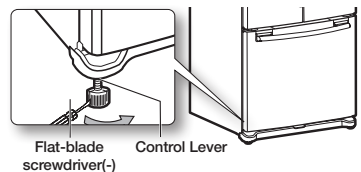

Flat-blade screwdriver(-) Control Lever

Setting up your French Door Refrigerator

FLOORING

For proper installation, this refrigerator must be placed on a level surface of hard material that is the same height as the rest of the flooring. This surface should be strong enough to support a fully loaded refrigerator, or approximately 223lbs(106kg). To protect the finish of the flooring, cut a large section of the cardboard carton and place under the refrigerator where you are working. When moving the refrigerator, be sure to pull it straight out and return it to position by pushing it straight in.

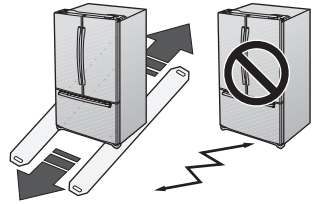

SETTING UP THE REFRIGERATOR

Now that you have your new Refrigerator installed in place, you are ready to set up and enjoy the features and functions of the appliance. By completing the following steps, your Refrigerator should be fully operational.

1. Place the Refrigerator in an appropriate location with reasonable clearance between it and the wall. Refer to installation instructions in this manual. (page 9, selecting the best location for the Refrigerator)
2. Once the Refrigerator is plugged in, make sure the interior light comes on when you open the doors.
3. Set the Temperature control to the coldest temperature and wait for an hour. The Freezer will get slightly chilled and the motor will run smoothly.
4. After powering the Refrigerator, it will take a few hours to reach the appropriate temperature. You can store food and drinks in the Refrigerator after the temperature is sufficiently cool.



Check the accessories listed below.



Compression fitting



Compression nut



Hex Wrench



Fastener

Required Tools (Not provided)



Phillips screwdriver(+)



Flat-blade screwdriver(-)

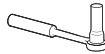

Socket Wrench
(10mm) (for bolts)



Hex Wrench (3/16")
(for Mid hinge)



Pliers

REMOVING THE REFRIGERATOR DOORS

Some installations require door/drawer removal to transport the Refrigerator to its final location. Do not remove the door/drawer if it is not needed. Before removing the door/drawer make sure you read following items.



WARNING Disconnect power to the Refrigerator before removing the door or drawer.



- Be careful not to drop, damage or scratch the door/drawer while removing them.
- Be careful not to get injured while removing the door/drawer.
- Reattach the door/drawer properly to avoid:
 - Moisture from air leakage.
 - Uneven door alignment.
 - Wasting energy due to improper door seal.

Disassembling the fridge door



Be careful not to drop and scratch the fridge door while removing the fridge door!

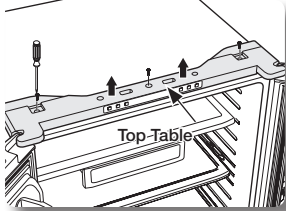

1. Remove the 3 screws holding down the top table and remove it.

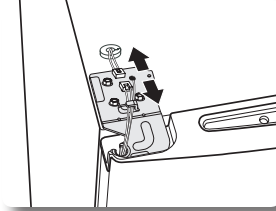

2. Disconnect electric wire on the top of the refrigerator.

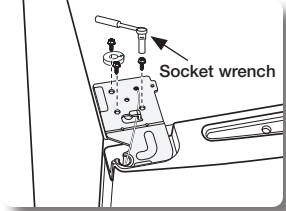

3. Remove the 3 hex bolts that hold the hinge on the top of the refrigerator with the 10mm socket wrench.

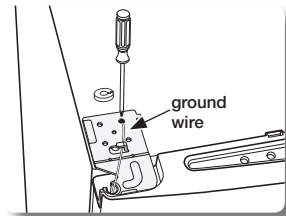

4. Remove the screw that holds the ground wire with a philips screwdriver(+).

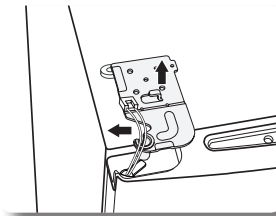

5. Separate the hinge from the electric wire and ground wire as shown above.

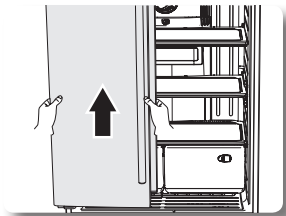

6. Lift the door straight up to remove. Be careful not to drop and scratch the doors while removing them.

Disassembling the freezer door

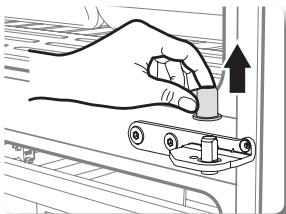

1. Separate the cap on the middle hinge.

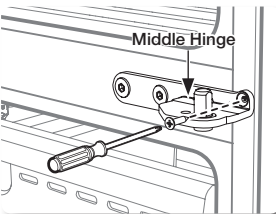

2. Remove the screw attached to the left and right middle hinges with a philips screwdriver(+). Remove the 2 hex head bolts attached to the left and right middle hinges with an allen wrench(3/16").

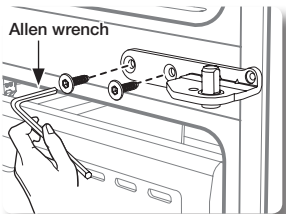

Setting up your French Door Refrigerator

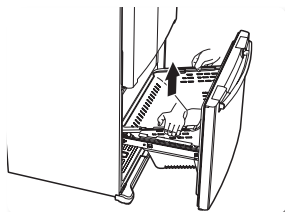

3. After opening the Freezer door, lift the drawer box.

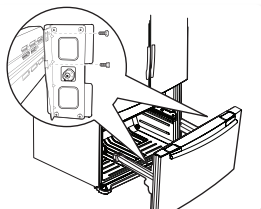

4. Remove 4 hex head bolts from both sides with a socket wrench(10mm)

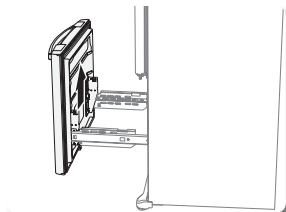

5. Lift up the freezer door from the rails.
Be careful not to drop and scratch the freezer door.

Reassembling the fridge door

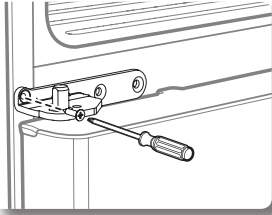

1. Insert and tighten the screw into the left and right middle hinges with a philips screwdriver(+).

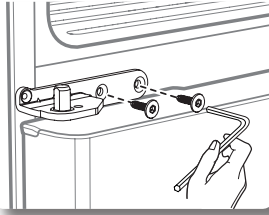

2. Insert and tighten the 2 hex head bolts into the left and right middle hinges with an allen wrench(3/16").

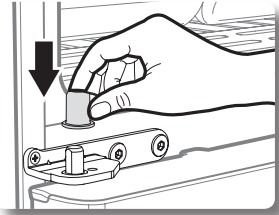

3. Replace the middle hinge cap.

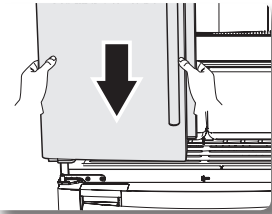

4. Place the hole in the bottom of the left door over the middle hinge.

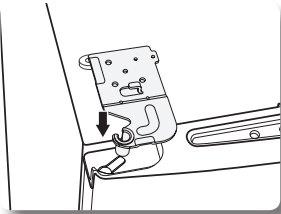

5. Insert the left upper hinge shaft into the hole on the corner of the fridge door.

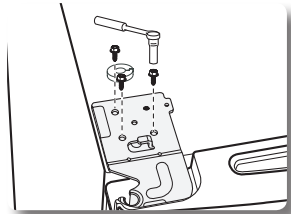

6. Insert the upper hinges into the holes at the top of the door. Insert and tighten the 3 hex head bolts into the left and right upper hinges with a socket wrench.

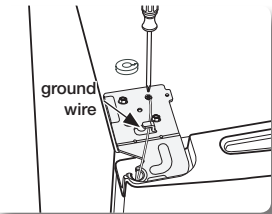

7. Insert and tighten the ground screw into the left and right upper hinges with a philips screwdriver(+).

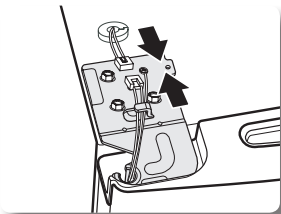

8. Connect the electronic wire on the top of the refrigerator.

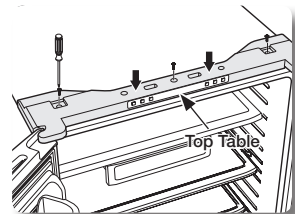

9. Position the top table in place. Insert and tighten the 3 screws into the top table with a philips screwdriver(+).

Setting up your French Door Refrigerator

Reassembling the freezer door (DRAWER TYPE - RF18,RF20)

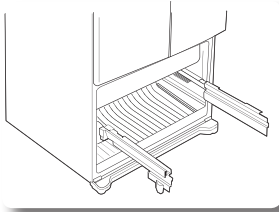

1. Pull out the rails to the full length on each side of the cabinet evenly.

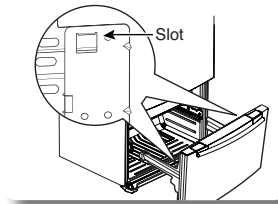

2. Hang the freezer door front onto open slot on the sides.

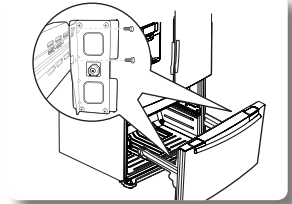

3. With the 10mm wrench, reattach 4 bolts to connect the rail with the door.

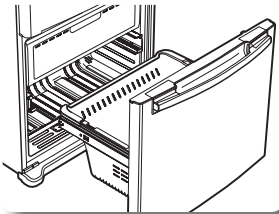

4. With the drawer pulled out fully, insert the drawer box into the rail system.

ADJUSTING THE DOORS

Now that the doors are back on the Refrigerator, you want to make sure the Refrigerator is level so that you can make final adjustments. If the Refrigerator is not level, it will not be possible to get the doors perfectly even.

When the Left door is lower than the Right door.

Insert a flat-blade screwdriver into a notch on the left control lever, turn it clockwise or counter-clockwise to level the left door.

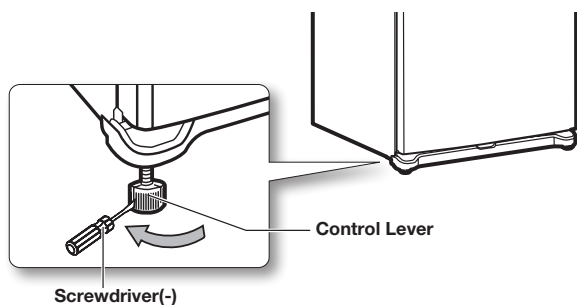

When the Left door is higher than the Right door.

Insert a flat-blade screwdriver into a notch on the right control lever, turn it clockwise or counter-clockwise to level the right door.

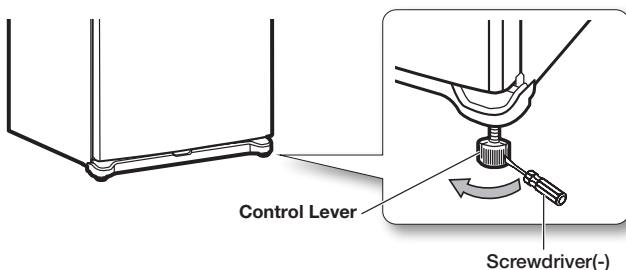

Both control levers must be surely touching the floor to avoid the possible personal injury or property damage because of tipping.

Setting up your French Door Refrigerator

MAKING MINOR ADJUSTMENTS BETWEEN DOORS

Remember, a level Refrigerator is necessary for getting the doors perfectly even. If you need help, review the previous section on leveling the Refrigerator.

When the left door is lower than the right door.

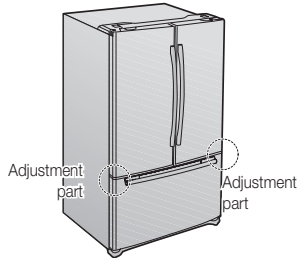
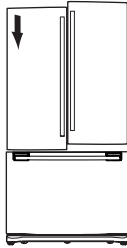

When the left door is higher than the right door.

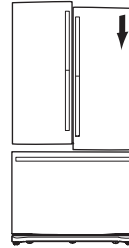

1. Pull out the freezer drawer (1), then you can see the middle hinge (2).
2. Insert the supplied hex wrench (3) into the shaft (4) of the middle hinge.
3. Please adjust the height by turning the hex wrench (3) clockwise (↻) or counter-clockwise (↺).

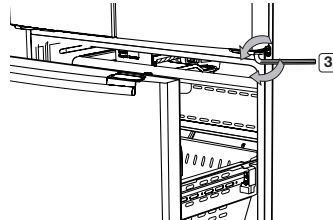
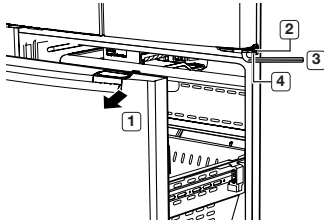

When you turn the hex wrench counter-clockwise (↺), the door will move up.

1. After adjusting the doors, please insert the supplied fastener (5) using Pliers (6) in the gap between the hinge-grommet (7) and the middle hinge (8). The number of fasteners you'll need to insert depends on the gap.

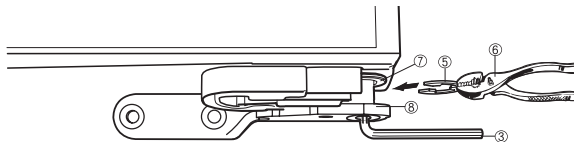

2 fastener are enclosed with the refrigerator.
The thickness of each fastener is 0.04".

INSTALLATION OF THE WATER LINE

Before You Install the water line

- The water line installation is not warranted by the refrigerator manufacturer.
So before you install the water line, read the whole steps for installing and follow these instructions carefully to minimize the risk of expensive water damage.
 - Banging pipes (water banging in the pipes) in house plumbing can cause damage to fridge parts and lead to water leakage or flooding. Call a qualified plumber to correct the problem before installing the water supply line to the fridge.
 - To prevent burns and product damage, do not hook up the water line to the hot water line.
 - Do not install the water line in areas where temperatures fall below freezing.
 - When using any electrical device (such as a power drill) during installation, be sure the device is insulated or wired in a manner to prevent electric shock.
 - All installations must be in a accordance with local plumbing code requirements.
-  • Water line Kit and water filter are not covered by Samsung's Warranty. The manufacturer (or dealer, installer) of them is responsible for any defects and all the loss caused by water filter & water line kit .
- The filter should be replaced according to manufacturer (or dealer)'s instruction.
 - To order additional water filters, please contact the manufacturer (or dealer) of the filter.

Using the water filter (not provided)

Connecting to water supply line

- Shut off the main water supply line and turn the Ice maker to the off position.
 - Locate the nearest cold drinking water line.
 - Follow the instructions in the water filter installation kit.
 - After connecting the water supply line to the Cartridge Holder inlet (insert plastic line in fully), install the Filter Cartridge.
 - Turn on water supply and Flush 3 gallons through filter before use (flush approximately 6 minutes)
-  • If you want to install a water filter, it must be installed outside the refrigerator.
It is not provided with your new refrigerator. The filter cartridge (8) and holder (9) kit can be purchased from the retailer where you purchased this refrigerator.
- Do not use copper line.
 - Cut the tubing, making sure the ends are square and clean.

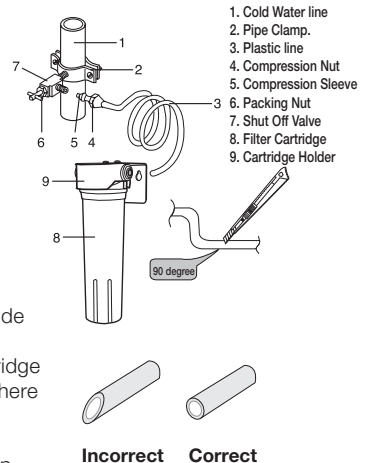

Setting up your French Door Refrigerator

Connect the water line to the fridge

- Connect the plastic line on the back of your fridge to the cartridge holder outlet (fully insert the plastic line to the cartridge holder outlet).
- Insert plastic clip to the cartridge holder inlet and outlet.
- Turn water on and check for any leakage.

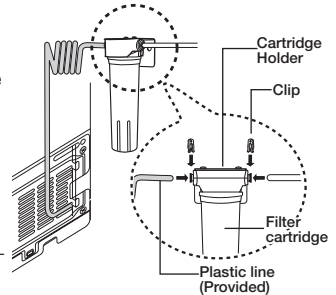

- You can purchase the necessary filter cartridge at the retailer where you purchased this refrigerator. Make sure you buy the SAMSUNG filter cartridge (Replacement cartridge No : DA29-00015A) to ensure the best performance.
- The water line must be connected to drinkable water only
- A compression fitting and nut kit is supplied with the unit and it is inside the fridge drawer.
- When pushing the Refrigerator back, make sure you don't roll over the power cord or water line (Icemaker supply line)

To use without the water filter

Connecting to the water supply line

- Shut off the main water supply line and turn the Ice maker to the off position.
- Locate the nearest cold water drinking line.

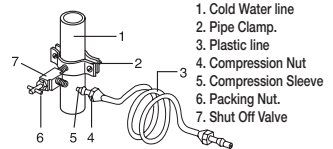

Connect the water line to the fridge

- 1) Slip the compression nut through the plastic tubing.
- 2) After inserting the compression nut into plastic tubing, tighten the compression nut onto 1/4" compression fitting(Provided).

- Do not overtighten the compression nut.
- Using Copper Tubing
 - Slip the compression nut and ferrule on copper tubing as shown.
- Using Plastic Tubing
 - Insert the molded end(Bulb) of the plastic tubing into the compression fitting.

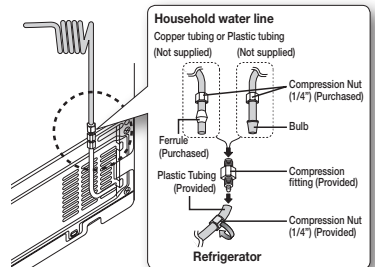

Do not use without the molded end(Bulb) of the plastic tubing.

- 3) Tighten the compression nut onto the compression fitting.
- 4) Turn water on and check for any leakage.

- Water line must be connected to drinkable water only.
- When pushing the Refrigerator back, make sure you don't roll over the power cord or water line (Icemaker supply line).

Operating your SAMSUNG Refrigerator

PARTS AND FEATURES

Use this page to become more familiar with the parts and features of the Refrigerator.

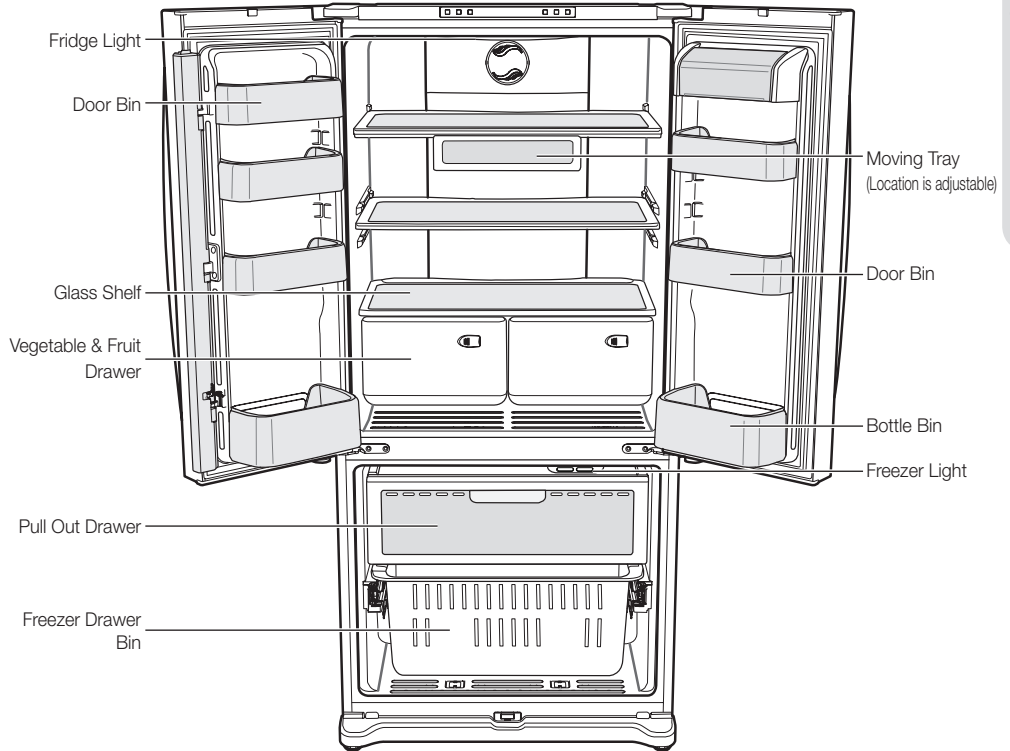

Operating your SAMSUNG Refrigerator

USING THE CONTROL PANEL

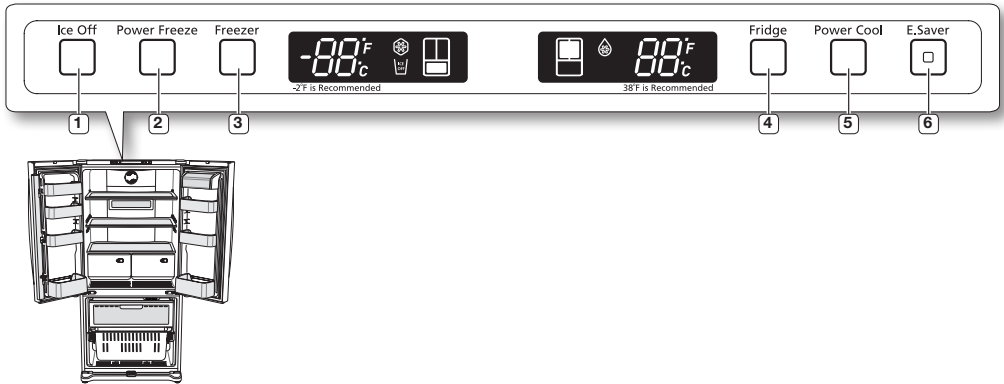

Temperature & Function select / control panel

(1) Ice Off Button

When the **Ice Off Button** is pressed, ice will not be produced.
Use this function only when it is needed.

(2) Power Freeze Button

Press this button to freeze food quickly.
(Power Freeze will last 2 and a half hours.)

(3) Freezer Button

Freezer temperature set button.
Press this button to set the Freezer temp between 8°F and -8°F.
(At initial power on, the default setting is -2°F.)

(4) Fridge Button

Fridge temperature set button.
Press this button to set the Fridge temperature in 2°F intervals between 46°F and 34°F.
(At initial power on, the default setting is 38°F.)

(5) Power Cool Button

Press this button to cool the food in the fridge quickly.
(Power Cool will shut off when 25°F is reached or after 2 and a half hours.)

(6) E.Saver Button

Press the Energy Saver button for better energy efficiency. If water drops appear on the doors, turn the Energy Saver function off.

CONTROLLING THE TEMPERATURE



Setting the freezer temperature

If you want to control the freezer temperature, follow as below.

Press the **Freezer** Button (Refer the picture)

- The temperature can be set in 2°F interval between -8°F and 8°F.
- Each time the **Freezer** Button is pressed, the temperature setting will change as follows; (-2°F → -4°F → -6°F → -8°F → 8°F → 6°F → 4°F → 2°F → 0°F → -2°F)

When selecting the temperature, the set temperature is displayed initially for 5 seconds, then the actual temperature is displayed. (There may be slight difference between the set temperature and displayed actual temperature, but it will be corrected to the set temperature automatically.)

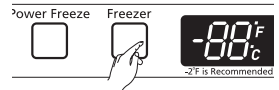

-  - The Freezer temperature will change depending on the number of door openings, quantity of food, ambient temperature, etc.
 - The temperature display will blink when freezer temperature increases due to frequent door opening, keeping warm food, etc.
- (Blinking will stop when the refrigerator reaches normal temperature. If for some reason it does not stop after a long period of time, contact a Samsung service center.)

Setting the fridge temperature

If you want to control the fridge temperature, follow as below.

Press the **Fridge** Button (Refer the picture)

- The temperature can be set in 2°F interval between 34°F and 46°F.
- Each time the **Fridge** Button is pressed, the temperature setting will change as follows; (38°F → 36°F → 34°F → 46°F → 44°F → 42°F → 40°F → 38°F)

Operating your SAMSUNG Refrigerator

When selecting the fridge temperature, the set temperature is displayed initially for 5 seconds, then the actual temperature is displayed. (There may be slight difference between the set temperature and displayed actual temperature, but it will be corrected to the set temperature automatically.)

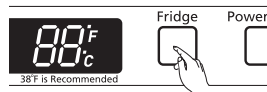

- The Fridge temperature will change depending on the number of door openings, quantity of food, ambient temperature, etc.
 - Temperature of each shelf or container in the fridge may be different.
 - The temperature display will blink when fridge temperature is increases due to frequent door opening, keeping warm food, etc.
- (Blinking will stop when the refrigerator reaches normal temperature. If for some reason it does not stop after a long period of time, contact a Samsung service center.)

If you want to make ice faster (Controlling the Power Freeze)

Press the **Power Freeze** Button. (Refer to the picture.)

- The power Freeze light on the display goes on (see the arrow mark) and this function begins to operate regardless of the set freezer temperature.

Press the **Power Freeze** Button again to cancel this function.

- The light goes off and it operates at the set freezer temperature again.

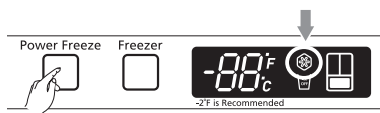

- The Power Freeze function operates for 2 and a half hours regardless of the set temperature.

If you want to speed up the cooling in the Fridge (Power Cool)

Press the **Power Cool** Button. (Refer to the picture.)

- The Power cool light on the display goes on (see the arrow mark) and this function begins to operate regardless of the set fridge temperature.

Press the **Power Cool** Button again to cancel this function.

- The light goes off and it operates at the set fridge temperature again.

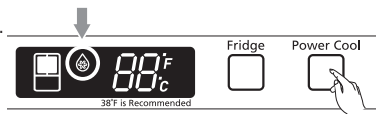

- The Power Cool function operates for 2 and a half hours regardless of the set temperature.

Cooling Off Mode (“OF & OF” code on the display)

 This function is for store display refrigerators. It is not for customer use.



In Cooling Off Mode, the refrigerator works but doesn't make cool air. To cancel this mode, press the Power Freeze and Freezer buttons at the same time for 3 seconds until a “Ding-dong” sound is heard. The unit will now cool.

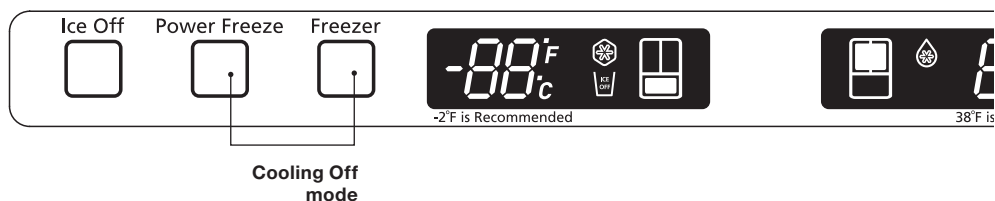

Ice Maker Operation

The ice maker will produce 8 cubes per cycle - approximately 100~130 cubes in a 24-hour period, depending on freezer compartment temperature, room temperature, number of door openings and other use conditions.

Throw away the first few batches of ice to allow the water line to clear.

Be sure nothing interferes with the sweep of the feeler arm.

When the bin fills to the level of the feeler arm, the icemaker will stop producing ice.

After the icemaker has been turned on again, there will be a time delay before the icemaker resumes operation.

It is normal for several cubes to be joined together.

If ice is not used frequently, old ice cubes will become cloudy, taste stale and shrink.

So if you don't want to make ice, press the Ice Off button.

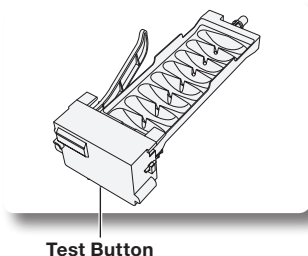





-  - When “Ice making” function is selected, ice-making is priority. Then the temperature of freezer will be lower than the setting temperature. If you don't need the “Ice making” function, please press the button of “Ice Off”.

Operating your SAMSUNG Refrigerator



STORING FOOD IN THE REFRIGERATOR



The Samsung Refrigerator has been designed to provide you with maximum space saving features and functions. Here are some of the customized compartments we have created to keep your food fresher longer. In order to further prevent odor from seeping into the ice compartment, stored food should be wrapped securely and as airtight as possible.

Moving Tray	Can be used to store small dairy items like butter or margarine, yogurt or cream cheese bricks	 butter/cheese
Bottle Bin	Designed to handle large, bulky items such as gallons of milk or other large bottles and containers.	
Fridge Shelves	Designed to be crack-resistant, the shelves can be used to store all types of food and drinks. Circular marks on the glass surface are a normal phenomenon and can usually be wiped clean with a damp cloth.	
Vegetable & Fruit Drawers	Used for preserving the freshness of your stored vegetables and fruits. This drawer has been specifically designed to control the level of humidity within the compartment. Keep vegetables and fruits separate when possible.	

-  Do not place any large articles of food under the lamp in the Refrigerator. An air sensor is located near the lamp and if the sensor is blocked, your Refrigerator may become too cold. Please place Vegetable and Fruits in the Vegetable and Fruits Drawers to avoid freezing them. If the food in your Refrigerator becomes frozen, please set the temperature higher.

STORING FOOD IN THE FREEZER DRAWER

Pull Out Drawer	Best used to store meats or dry foods. Stored food should be placed in a container or wrapped securely using plastic wrap or other suitable wrapping materials.	
Freezer Drawer Bin	Can be used to store meat and dry foods. Stored food should be placed in a container or wrapped securely using plastic wrap or other suitable wrapping materials.	

-  Bottles should be stored tightly together so that they do not tip and fall out when the Refrigerator door is opened.
-  If you plan to go away for a long time, empty the Refrigerator and turn it off. Wipe the excess moisture from the inside of the appliance and leave the doors open. This helps keep odor and mold from developing.

FOOD STORAGE TIPS

Foods	Refrigerator	Freezer	Storage Tips
DAIRY PRODUCTS			
Butter	2-3 Weeks	6-9 Months	Wrap or cover tightly.
Milk	1-2 Weeks	Not recommended	Check date code. Most milk and similar products are sold in date-coded cartons that indicate a product's peak freshness. Re-seal with cap or wrap tightly. Do not return unused portions to original container.
Cream Cheese, cheese food, and cheese spread	2-4 Weeks	Not recommended	Check date code. Keep all cheese tightly packed in moisture proof wrap
Hard Cheese (un-opened)	3-4 Months	6 Months	
Hard Cheese (opened)	2 Months	Not recommended	
Cottage Cheese	10-15 Days	Not recommended	
Cream	7-10 Days	2 Months	Check date code. Most yogurt, creams, and similar products are sold in date-coded cartons that indicate a product's peak freshness. Re-seal or cover tightly. Do not return unused portions to original container.
Sour Cream	2 Weeks	Not recommended	
Cream Dips (opened)	1 Week	Not recommended	
Yogurt	10-14 Days	Not recommended	Check date code. Keep covered.
Frozen Yogurt	n/a	2 Months	
EGGS			
Eggs (uncooked)	3-4 Weeks	Not recommended	Check date code. Store eggs in coldest part of refrigerator and in their original container.
Eggs (cooked)	1 weeks	Not recommended	Store in covered container
Leftover egg dishes	3-4 Days	Not recommended	Store in covered container
FRESH FRUITS			
Apples	1 Month	Not recommended	If storing in refrigerator, do not wash fruit before storing. Store in moisture resistant bags or containers. Wrap cut fruits. Some fruits darken when refrigerated.
Bananas	2-4 Days	Not recommended	
Peaches, Melons, Pears, Avocados	3-5 Days	Not recommended	
Berries and Cherries	2-3 Days	12 Months	
Apricots	3-5 Days	Not recommended	
Grapes	2-5 Days	n/a	
Pineapple (un-cut)	2-3 Days	Not recommended	
Pineapple (cut)	5-7 Days	6-12 Months	
Citrus	1-2 Weeks	Not recommended	Store uncovered.
Juice	6 Days	Not recommended	Check date code and re-seal in original container. Do not return unused portions to original container.
Frozen Juice	Thawing only	12 Months	Check date code. Do not re-freeze.
FISH AND SHELLFISH			

Operating your SAMSUNG Refrigerator

Foods	Refrigerator	Freezer	Storage Tips
Fish			
Fatty Fish (mackerel, trout, salmon)	1-2 Days	2-3 Months	Keep in original wrapper and store in coldest part of refrigerator. Package in vapor-proof and moisture proof wrap for freezer. Freeze at 0°F. Thaw in refrigerator or Check date code. Freeze in original packaging.
Lean Fish (cod, flounder, etc)	1-2 Days	6 Months	
Frozen or Breaded	n/a	3 Months	
Shellfish			
Shrimp (uncooked)	1-2 Days	12 Months	Freeze package in vapor and moisture-proof container.
Crab	3-5 Days	10 Months	
Cooked Fish or Shellfish	2-3 Days	3 Months	
MEAT			
Fresh, Uncooked			
Chops	2-4 Days	6-12 Months	Check date code for use. Store in coldest part of refrigerator in original packaging. Use additional moisture and vapor-proof container for freezing. Recommended refrigerator temperature 33°F to 36°F and freezer temperature 0°F to 2°F
Ground	1 Day	3-4 Months	
Roast	2-4 Days	6-12 Months	
Bacon	1-2 Weeks	1-2 Months	
Sausage	1-2 Days	1-2 Months	
Steak	2-4 Days	6-9 Months	
Poultry	1 Day	12 Months	
Lunch meat	3-5 Days	1 Month	
Cooked			
Meat	2-3 Days	2-3 Months	Check date code for use. Store in coldest part of refrigerator in original packaging. Place package in moisture and vapor-proof container for freezing.
Poultry	2-3 Days	4-5 Months	
Ham	1-2 weeks	1-2 Months	

Sources:

American Meat Institute Foundation. 1994. Yellow pages: answers to predictable questions consumers ask about meat and poultry.
 American Meat Institute Food Marketing Institute. 1999. The food keeper. Food Marketing Institute, Washington, D.C. Freeland-Graves, J.H. and G.C. Peckham. 1996. Foundations of food preparation, 6th ed. Prentice-Hall, Inc. Englewood Cliffs, NJ. Hillers, V.N. 1993. Storing foods at home. Washington State University Cooperative Extension, Pullman, WA. Publ. EB 1205.
 National Restaurant Association. 2001. Be cool-chill out! Refrigerate promptly. National Restaurant Association Education Foundation^{1/4}
 International Food Safety Council, Washington, D.C. USDA. 1997. Basics for handling food safely. U.S. Department of Agriculture, Food Safety and Inspection Service, Washington, D.C.

REMOVING THE FRIDGE ACCESSORIES

1. Door Bins

To remove - Simply lift the bin up and pull straight out.

To replace - Slide it in above the desired location and push down until it stops.



Injury may occur if the door bins are not firmly inserted. Do not allow children to play with bins. Sharp corners of the bins may cause injury.



Do not adjust a bin full of foods.

Dust removal method -Remove the guard and wash in water.

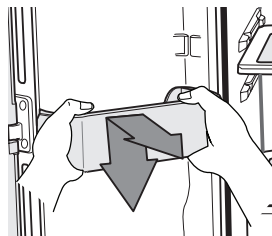

2. Fridge shelves

To remove - When pulling out the shelf, if it does not slide out easily, lift it up slightly and pull out again.

To replace - When pushing in the shelf, if it does not slide in easily, lift it up slightly and push in again.



The Glass shelves are heavy. Use special care when removing them.

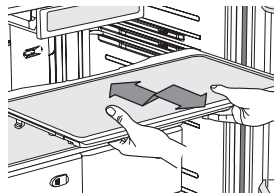

3. Vegetable & Fruit Drawers

To remove - Pull the drawer out to full extension. Tilt up the front of the drawer and pull straight out. (Refer to picture 1-3)

To replace - Insert the drawer into the frame rails and push back into place. (Refer to picture 4)

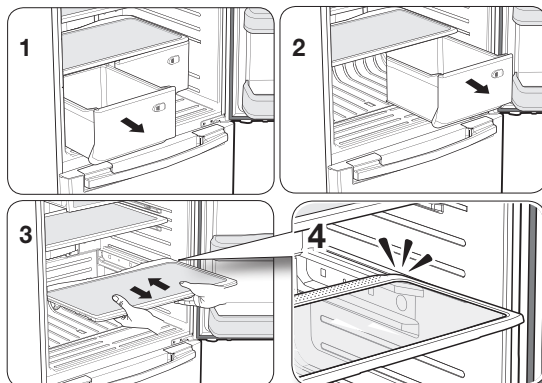

The drawers need to be removed before the glass shelf above them can be lifted out.

Operating your SAMSUNG Refrigerator

REMOVING THE FREEZER ACCESSORIES

1. Pull Out Drawer

To remove - Pull the drawer out to full extension.
Tilt up rear of drawer and lift straight out.
(Refer to picture 1 & 2)

Open the freezer door fully and remove the drawer.

To replace - Place the drawer onto the rails by tilting it up. Lower the drawer into place until it is horizontal and slide the drawer in.
(Refer to picture 3)

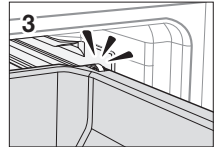
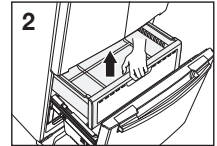
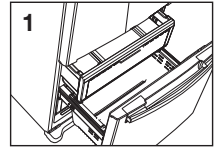

2. Freezer Drawer Bin

To remove the drawer - Pull the drawer out fully. Tilt up the rear of the bin and lift it out to remove.

To relocate the drawer - Place the bin into the rail assembly.

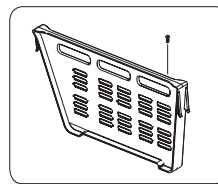
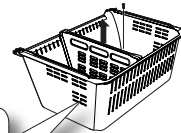
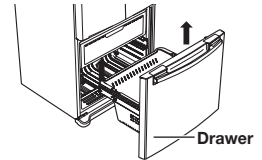

Do not allow baby or children go inside the drawer bin. They could damage the Refrigerator and seriously injure themselves. Do not sit on the Freezer door. The door may break. Do not allow children to climb into the Freezer basket.



If you remove the divider to clean the basket bin, you must reinstall the divider using 1 screw after cleaning to prevent children from getting trapped inside the basket.

CLEANING THE REFRIGERATOR

Caring for your Samsung Refrigerator prolongs the life of your appliance and helps keep it odor and germ-free.

Cleaning the Interior

Clean the inside walls and accessories with a mild detergent and then wipe dry with a soft cloth. You can remove the drawers and shelves for a more thorough cleaning. Just make sure to dry drawers and shelves before putting them back into place.

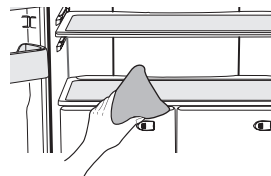

Cleaning the Exterior

Wipe the display panel with a damp, clean and soft cloth. Do not spray water directly on the surface of the Refrigerator.

The doors, handles and cabinet surfaces should be cleaned with a mild detergent and then wiped dry with a soft cloth. To keep your appliance looking its best, the exterior should be polished once or twice a year.

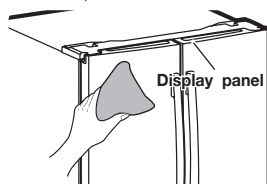

CAUTION Do not use Benzene, Thinner, car detergent, or Clorox for cleaning. They may damage the surface of the appliance and may cause fire.

Printed letters on the display may come off if you spray the cleaning products directly on the product.



Cleaning the Rubber door seals

If the rubber door seals are dirty, the doors may not close properly, and the Refrigerator will not operate efficiently. Keep the door seals free of grit or grime by cleaning the doors with a mild detergent and damp cloth. Wipe dry with a clean, soft cloth.

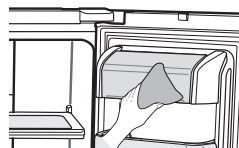

Cleaning behind the Refrigerator

To keep cords and exposed parts free of dust and dirt accumulation, vacuum behind the appliance once or twice a year.



CAUTION Do not remove the back cover. Doing so may cause an electric shock.

Operating your SAMSUNG Refrigerator

CHANGING THE INTERIOR LIGHTS



Do not disassemble or replace the LED type Lighting.

To change the LED Type Lighting contact Samsung service center or your authorised Samsung dealer.



If Users randomly exchange the LED lamp by yourself, this may result in electric shock or personal injury.



When the interior or exterior LED lamp has gone out, please contact your service agents.

SAMSUNG CUSTOMER CARE CENTER

Samsung Electronics America, Inc. 85 Challenger Road Ridgefield Park, NJ 07660
1-800-SAMSUNG (1-800-726-7864) and www.samsung.com



Clean the ice box if there are some small pieces of ice on the bottom.



Throw away the coherent ice if the ice maker is not used for long time.

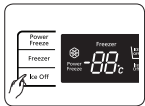

Set "Ice Off" for saving energy if the ice maker will not be used for long time.

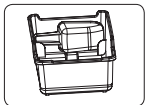

If you want to buy and use a tool of shoveling ice, put it into special place of ice box or take it out.

Troubleshooting

PROBLEM	SOLUTION
<p>The Refrigerator does not work at all or it does not chill sufficiently.</p>	<ul style="list-style-type: none"> • Check that the power plug is properly connected. • Is the temperature control on the display panel set to the correct temperature? Try setting it to a lower temperature. • Is the Refrigerator in direct sunlight or located near a heat source? • Is the back of the Refrigerator so close to the wall that air cannot keep circulating? (Refer to page 10 for the best location.)
<p>The food in the Refrigerator is frozen.</p>	<ul style="list-style-type: none"> • Is the temperature control on the display set to the correct temperature? Try setting it to a warmer temperature. • Is the temperature in the room too low? • Did you store the food too close to the air vent at the back of the Refrigerator? Move the food away from the air vent.
<p>You hear unusual noise or sounds.</p>	<ul style="list-style-type: none"> • Check that the Refrigerator is level and stable. • Is the back of the Refrigerator too close to the wall and therefore keeping air from circulating? • Was anything dropped behind or under the Refrigerator? • A “ticking” sound is heard from inside the Refrigerator. It is normal and occurs because various accessories are contracting or expanding according to the temperature of the Refrigerator interior. • When the automatic ice maker is on, ice is made in the ice container. After the ice is made, the container inverts and the ice falls into the storage compartment and water flows through the water valve. These operations cause noise at regular intervals, but that noise is normal.
<p>The front corners and vertical hinged section of the appliance are hot and condensation is occurring.</p>	<ul style="list-style-type: none"> • Some heat is normal as anti-condensators are installed in the vertical hinged section of the Refrigerator to prevent condensation. • Is the Refrigerator door ajar? Condensation can occur when you leave the door open for a long time.
<p>Ice Maker is not producing ice.</p>	<ul style="list-style-type: none"> • Did you wait for 12 hours after installation of the water supply line before making ice? • Is the water line connected and the shut-off valve opened? • Did you manually stop the ice making function? • Is the Freezer temperature too warm? Try setting the Freezer temperature lower.
<p>You hear water bubbling in the Refrigerator.</p>	<ul style="list-style-type: none"> • This is normal. The bubbling comes from the Refrigerator coolant liquid circulating through the Refrigerator.
<p>There is a bad smell in the Refrigerator.</p>	<ul style="list-style-type: none"> • Check for spoiled food. • Foods with strong odors(for example, fish) should be tightly covered. • Clean out your Freezer periodically and throw away any spoiled or suspicious food.
<p>Frost forms on the walls of the Freezer.</p>	<ul style="list-style-type: none"> • Is the air vent blocked? Remove any obstructions so air can circulate freely. • Allow sufficient space between the foods stored for efficient air circulation. • Is the Freezer drawer closed properly?
<p>Water dispenser is not functioning. (Water dispenser models only)</p>	<ul style="list-style-type: none"> • Is the water line connected and the shut-off valve opened? • Has the water supply line tubing been crushed or kinked? Make sure the tubing is free and clear of any obstruction. • Is the water tank frozen because the Refrigerator temperature is too low? Try selecting a warmer setting on the main display panel.

Warranty(USA)

WARRANTY ON SAMSUNG REFRIGERATOR

LIMITED WARRANTY TO ORIGINAL PURCHASER

This Samsung brand product, as supplied and distributed by Samsung Electronics America, Inc. (Samsung) and delivered new, in the original carton to the original consumer purchaser, is warranted by Samsung against manufacturing defects in materials and workmanship for a limited warranty period of:

One (1) year Parts and Labor on Refrigerator

Five (5) years Parts and Labor on sealed Refrigeration system only*

Ten (10) years Parts and Five (5) years Labor on Digital Inverter Compressor

(*Compressor, evaporator, condenser, drier, connecting tubing)

This limited warranty begins on the original date of purchase, and is valid only on products purchased and used in the United States. To receive warranty service, the purchaser must contact Samsung for problem determination and service procedures. Warranty service can only be performed by a Samsung authorized service center. The original dated bill of sale must be presented upon request as proof of purchase to Samsung or Samsung authorized service center.

Samsung will repair or replace any part found to be defective, at our option and at no charge as stipulated herein, with new or reconditioned parts during the limited warranty period specified above. All replaced parts and products become the property of Samsung and must be returned to Samsung. Replacement parts and products assume the remaining original warranty, or ninety (90) days, whichever is longer.

In-home service will be provided during the warranty labor period subject to availability within the contiguous United States. In-home service is not available in all areas. To receive in-home service, the product must be unobstructed and accessible from floor level to service personnel. If during in-home service repair cannot be completed, it may be necessary to remove, repair and return the product. If in-home service is unavailable, Samsung may elect, at our option, to provide for transportation of our choice to and from a Samsung authorized service center. Otherwise, transportation to and from the Samsung authorized service center is the responsibility of the purchaser.

This limited warranty covers manufacturing defects in materials and workmanship encountered in normal, noncommercial use of this product, and shall not apply to the following, including, but not limited to: damage which occurs in shipment; delivery and installation; applications and uses for which this product was not intended; altered product or serial numbers; cosmetic damage or exterior finish; accidents, abuse, neglect, fire, water, lightning or other acts of nature; use of products, equipment, systems, utilities, services, parts, supplies, accessories, applications, installations, repairs, external plumbing and leaks, external wiring, circuit breakers, fuses or connectors not supplied and authorized by Samsung, or which damage this product or result in service problems; incorrect electrical line voltage, fluctuations and surges; customer adjustments and failure to follow operating instructions, cleaning, maintenance and environmental instructions that are covered and prescribed in the instruction book; loss of food due to spoilage; consumable items including filters and light.

THERE ARE NO EXPRESS WARRANTIES OTHER THAN THOSE LISTED AND DESCRIBED ABOVE, AND NO WARRANTIES WHETHER EXPRESS OR IMPLIED, INCLUDING, BUT NOT LIMITED TO, ANY IMPLIED WARRANTIES OF MERCHANTABILITY OR FITNESS FOR A PARTICULAR PURPOSE, SHALL APPLY AFTER THE EXPRESS WARRANTY PERIODS STATED ABOVE, AND NO OTHER EXPRESS WARRANTY OR GUARANTY GIVEN BY ANY PERSON, FIRM OR CORPORATION WITH RESPECT TO THIS PRODUCT SHALL BE BINDING ON SAMSUNG. SAMSUNG SHALL NOT BE LIABLE FOR LOSS OF REVENUE OR PROFITS, FAILURE TO REALIZE SAVINGS OR OTHER BENEFITS, OR ANY OTHER SPECIAL, INCIDENTAL OR CONSEQUENTIAL DAMAGES CAUSED BY THE USE, MISUSE OR INABILITY TO USE THIS PRODUCT, REGARDLESS OF THE LEGAL THEORY ON WHICH THE CLAIM IS BASED, AND EVEN IF SAMSUNG HAS BEEN ADVISED OF THE POSSIBILITY OF SUCH DAMAGES. NOR SHALL RECOVERY OF ANY KIND AGAINST SAMSUNG BE GREATER IN AMOUNT THAN THE PURCHASE PRICE OF THE PRODUCT SOLD BY SAMSUNG AND CAUSING THE ALLEGED DAMAGE. WITHOUT LIMITING THE FOREGOING, PURCHASER ASSUMES ALL RISK AND LIABILITY FOR LOSS, DAMAGE OR INJURY TO PURCHASER AND PURCHASER'S PROPERTY AND TO OTHERS AND THEIR PROPERTY ARISING OUT OF THE USE, MISUSE OR INABILITY TO USE THIS PRODUCT SOLD BY SAMSUNG NOT CAUSED DIRECTLY BY THE NEGLIGENCE OF SAMSUNG. THIS LIMITED WARRANTY SHALL NOT EXTEND TO ANYONE OTHER THAN THE ORIGINAL PURCHASER OF THIS PRODUCT, IS NONTRANSFERABLE AND STATES YOUR EXCLUSIVE REMEDY.

Some states do not allow limitations on how long an implied warranty lasts, or the exclusion or limitation of incidental or consequential damages, so the above limitations or exclusions may not apply to you. This warranty gives you specific legal rights, and you may also have other rights, which vary from state to state. To obtain warranty service, please contact Samsung at:

SAMSUNG CUSTOMER CARE CENTER

Samsung Electronics America, Inc. 85 Challenger Road Ridgefield Park, NJ 07660
1-800-SAMSUNG (726-7864) and www.samsung.com/us/support

If your refrigerator needs service

Do not hesitate to call any Samsung Authorized Service Center nearby giving them your name, address and telephone number when your product is not functioning properly.

Warranty Information (CANADA)

Limited Warranty for Original Purchaser

This Samsung product is warranted by Samsung Electronics Canada Inc. against manufacturing defects in material or workmanship for the following periods:

Labor : 1 years (in-home)

Parts : 1 years

Inverter Compressor : 10 years

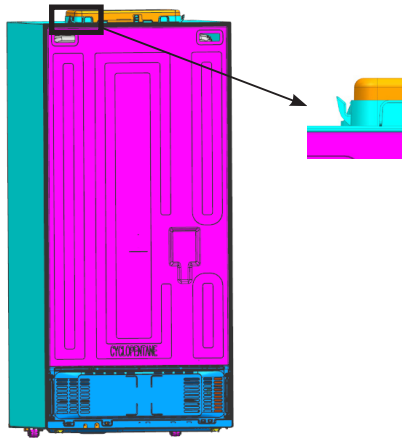

RF18**RF20**

Caution: Please clamp the power cord into the hook to prevent the power cord from being worn or damaged when the refrigerator isn't working or being moved.



 In an effort to promote recycling this user manual is printed on recycled paper.