

SALAMANDER
DESIGNS

REFERENCE GUIDE





FURNITURE
SHAPED BY YOUR NEEDS®



SALAMANDER DESIGNS

For over 25 years, Salamander Designs has been designing and manufacturing high-quality, customizable AV furniture.

"Salamander furniture is shaped by your needs"

We specialize in offering exceptional choice when shopping for functional products that integrate technology with your lifestyle.

We take pride that we build best-of-class AV furniture. Our Design Your Own concept allows Salamander customers to bring their personal visions to life.

Our approach to furniture manufacturing blends a specific design philosophy that fuses visual design, engineering and craftsmanship.

"Salamander systems start with a strong foundation"

And our products are Engineered to Perform, designed to enhance and evolve with changing technology needs and preferences.

Salamander Designs ... Elevating the Furniture Experience.



Sustainability is part of our DNA. We build things to last a lifetime. And we strive to tread lightly on our environment, from the materials we select, to manufacturing processes we employ, to our **100% solar powered factory**.



Throughout our history, we have been committed to building as many of our products as possible in the USA.



For 16 years straight Salamander leads the furniture category, according to CE Pro Magazine.



Our business is fueled by a passionate commitment to create the highest quality AV furniture on the market, shaped by the needs of our customers.

Salvatore Carrabba - Founder





6 AV Furniture

- 14 Chameleon Collection (C-Frame)
 - 32 Barcelona
 - 36 Berlin
 - 38 Chicago
 - 40 Corsica
 - 42 Denver
 - 46 Elba
 - 48 Hampton
 - 50 Lancaster
 - 52 Miami
 - 54 Milan
 - 56 Oslo
 - 58 Seattle
 - 60 Sonoma
 - 62 Venice
 - 64 Zurich

- 66 Synergy System (S-Frame)
- 82 Synergy Solutions
- 85 Synergy Pro Audio Racks
- 90 Archetype System (A-Frame)

93 AV Furniture Accessories

- 94 TV Integration
- 95 Speaker Integration
- 96 Interior Storage
- 97 Shelves
- 97 In-Cabinet Refrigerator
- 99 Pro Rack Mounting
- 100 Active Cooling & Rear Panels
- 101 Integrated Power
 - Power Conditioner
 - Power Distributor Unit
- 102 Footing
- 103 Wall Mount Kits
- 104 Accent Lighting
- 104 IR Repeater
- 104 Security Locks & Rears

105 Saddle iPad Holder

106 Custom Seating

- 114 Luca
- 116 Lilliana
- 118 Isabella
- 120 Olivia
- 122 Talia
- 124 Matteo
- 126 Alex
- 128 Tables, Ottomans & Accessories

130 AV Basics

- 132 AV Cabinets
- 134 Theater Seating

136 TV Mounts

- 137 Projector Mount
- 137 Motorized Mounts
- 137 Wall Mounts
- 94 Cabinet Integrated Mount

138 Office Collaboration Workspace Solutions

141 Product Warranties

LUCA & LILLIANA SEATING



NOW AVAILABLE IN
PREMIUM ALABASTER
LUXE LEATHER



Lilliana Seating in Luxe Premium Leather, Onyx with Oyster Piping

AV FURNITURE

Audio Video cabinets are essentially the control center for any media room's AV components. At Salamander, we don't build custom cabinets just to house and support your TV—but everything that comes with it. Every facet of our design process serves a purpose, from vibration damping construction and cabinet ventilation to cable management and storage options.



Corisca 339

DESIGN YOUR OWN

YOUR FURNITURE HELPS DEFINE YOUR SPACE



You may prefer a sleek contemporary look, or something more traditional. Having choices - being able to Design Your Own - is essential in finding the perfect furniture to match your decor. That is why we offer a wide range of style options and features, like exotic Wenge finish, textured natural wood doors, or high-gloss black glass for dramatic effect. And whether your cabinet is wall-mounted or “grounded” with stylish footings, you’ll find the perfect AV furniture solution.

DYO



Seattle 237

ON-WALL

The wall hanging cabinet is the ultimate way to create the look of custom cabinetry. It creates the illusion that your cabinet is floating above the floor. Best of all, installation is simple. Just remove the standard cabinet feet, install the specialized wall hanging brackets and presto. See wall bracket on Page 103.



Elba 247



Zurich 245

FIT YOUR STYLE & SPACE

Decorator feet and wheels fine tune the style and functional.



Chicago 245



Miami 247 on Tube Base



ENGINEERED TO PERFORM

THE ESSENTIAL FUNCTION

Salamander produces specialized AV furniture and accessories that are Engineered To Perform - designed to satisfy the functional requirements of both professional AV integrators and AV enthusiasts. Keen attention to the smallest details result in a heightened audio visual experience.

Thoughtful technology solutions such as our cabinet cooling features increase the performance and longevity of electronic components. Additionally, all cabinets feature Interior **Storage options**, **Cooling**, **IR Passing**, **Removable Rears** and **Interior Cable Raceways**, **Integrating TV's or Speakers** into the cabinet.

SPEAKER INTEGRATION

AV Cabinets accommodate a wide range of speaker types and sizes. Salamander has partnered with Leon Speakers to offer custom-made premium soundbars to fit most Salamander cabinets. These center channel and LCR speakers are designed specifically to fit any cabinet.



Synergy 236, Cherry/Black



Synergy 329, Cherry/Black



BUILT TO LAST

NOBODY BUILDS FURNITURE LIKE WE DO

At Salamander, we build things to last a lifetime, utilizing the finest, **sustainable materials** and **cutting edge construction** methods. We pay close attention to each component for its balance of function, durability, comfort and style. The **structural integrity** and **flexibility** of our systems are of utmost importance, and nowhere is this better illustrated than looking inside to the heart of each custom cabinet - a **precision-engineered** aluminium frame that puts us in a class by ourselves. All finished customized AV furniture is **built-to-order in the USA** and carries a **lifetime warranty**.



TECH RACK

Now, for the first time, it is possible to own Pro Audio Rack Mount cabinets that look like furniture.

All rack mount cabinets are constructed of premium components with exceptional attention to detail, reliability and durability. Mounting rails are compatible with industry EIA 19" component standards and include lacing bars to help manage wires.





CHAMELEON SYSTEM

Chameleon combines art and technology in sophisticated designs to fit in almost any decor.

CHAMELEON SYSTEM STYLES



*MULTIPLE TOP
OPTIONS AVAILABLE



FABRICATE YOUR OWN SKINS
Ask about our frame only option.



BARCELONA GLASS
Natural Walnut, Black Glass
Doors, Beveled Edge Top



BARCELONA WHITE
Natural Walnut, Warm White
Doors, Beveled Edge Top



BERLIN*
Wenge, Wave-Texture Doors,
with Black, Glass Top



CHICAGO*
Black Oak, Grass-Textured
with Black, Glass Top



CORSICA
American Cherry, Wood Rail &
Stile, Smoke Glass Door
with Hidden Finger Pull



DENVER - OAK*
Natural Oak, Bark-Textured
with Black, Glass Top



DENVER - WALNUT*
Medium Walnut, Bark-Textured
with Black, Glass Top



ELBA
American Cherry
Rail & Stile, Smoke Glass Door



HAMPTON
Distressed Black, Raised
Panel with Wood Knob



LANCASTER
Textured Barn Board Top,
Doors, and Side Panel



MIAMI*
Gloss Warm White Door,
with Black, Glass Top



MILAN*
Geometric Three-Dimensional,
Diamond Pattern, Black Glass Top



OSLO*
Wenge Sides, Black, Glass
Doors with Black, Glass Top



SEATTLE*
Alpi Gray Oak, Vertical Grass
Textured with Black, Glass Top



SONOMA
American Cherry
Mullions & Black Perf. Metal Door



VENICE
Antique Cherry, Miter Frame
and Panel Doors with Aged
Brass Knobs



ZURICH*
Opium Brown, Linear Textured
with Black, Glass Top



CHAMELEON AV CABINETS

Underneath the hood is the C-frame, a unique aluminum chassis that provides a strong and flexible furniture platform. Expertly finished furniture panels are attached to the C-frame to create various styles, and the internal chassis permits a wide variety of bolt-on options and accessories.



Denver Oak 247

Pinch-Out Rears
permit fast, easy access to components and wiring.



Wire Management



Customize Interiors



Infinitely Adjustable Shelves

Extruded Aluminum Frame
create a support skeleton.

Ventilation
Built-in louvers for better air flow to keep equipment cool.

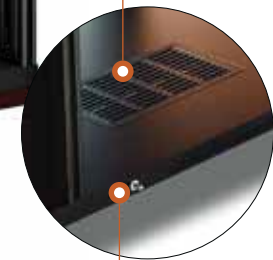

Soft-Close Doors

Customize
with designer feet,
wheels or mount on wall

CHAMELEON AV CABINETS

A - Single-Width Compartment
19.75"W x 19.5"D x 17.75"H

A1 - Subwoofer Compartment
19.75"W x 19.5"D x 17.75"H

B - Single-Width Compartment
19.75"W x 19.5"D x 27.75"H

C - Media Drawer
18.625"W x 18"D x 7.75"H
holds 75 DVD's and or 111 CD's

**D - Single-Width Center Speaker /
Multi-Functional Compartment**
19.75"W x 19.5"D x 9"H

**G - Double-Width Center Speaker /
Multi-Functional Compartment**
40.5"W x 19.5"D x 9"H

**F - Triple-Width Center Speaker /
Multi-Functional Compartment**
61.25"W x 19.5"D x 9"H

**H - Double-Width Center Speaker /
Multi-Functional Compartment**
40.5"W x 19.5"D x 8.15"H

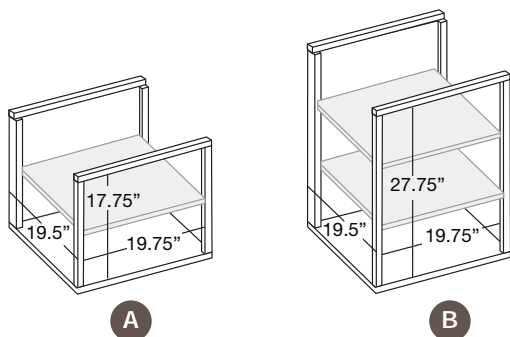

AUDIO CABINETS



217



317



517



617

AUDIO VIDEO CABINETS



221

*TV Size: up to 50"



323

*TV Size: up to 50"



237

*TV Size: up to 75"



337

*TV Size: up to 75"



247

*TV Size: up to 90"



347

*TV Size: up to 90"

SPEAKER INTEGRATED AV CABINETS – Includes Speaker Grill



329

*TV Size: up to 50"



326

*TV Size: up to 75"

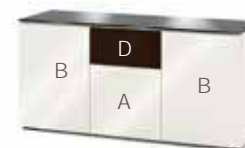

336

*TV Size: up to 75"



339

*TV Size: up to 75"



217

SUBWOOFER ENCLOSURE



245

*TV Size: up to 90"



345

*TV Size: up to 90"



CHAMELEON PROJECTOR CABINETS

A simple installation with no need to open the wall or ceiling to run cables. All supporting components including a speaker system can be enclosed in the credenza to provide a beautiful and simple solution.

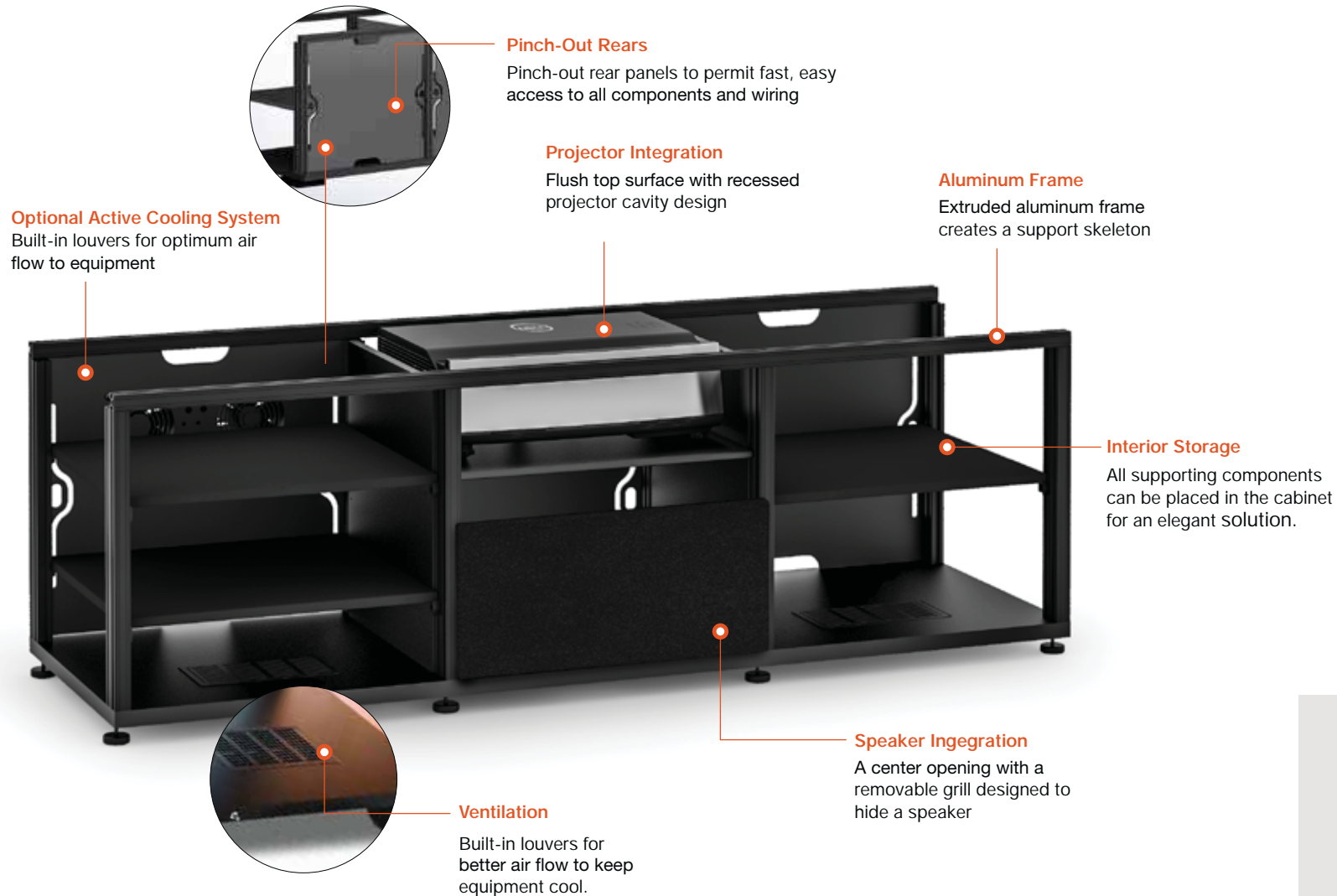

Advanced Accessories

- IR repeater system required to control projector
- Variety of bolt-on options and accessories are also available

SEAMLESS INTEGRATION FOR EVERY BRAND AND PROJECT

SONY



Dual Speaker Grill

Hisense

Model: 100L8D, 100L10E, 120L10E, 150L10E



Single Speaker

EPSON

Model: LS100



Single Speaker

vivitek
Vivid Color. Vivid Life.

Model: DH765Z-UST, DW763Z-UST



* SONY Projector Cabinet is available in Miami, Oslo and Chicago only.

LG

Model: LGHU85LA

Dual Speaker Grill



Single Speaker



* LG Projector Cabinet is available in Miami, Oslo, Chicago and Siena only.



CHAMELEON PRO AUDIO RACKS

All rack mount cabinets are constructed of premium components with exceptional attention to detail, reliability and durability. Mounting rails are compatible with industry EIA 19" component standards and include lacing bars to help manage wires.

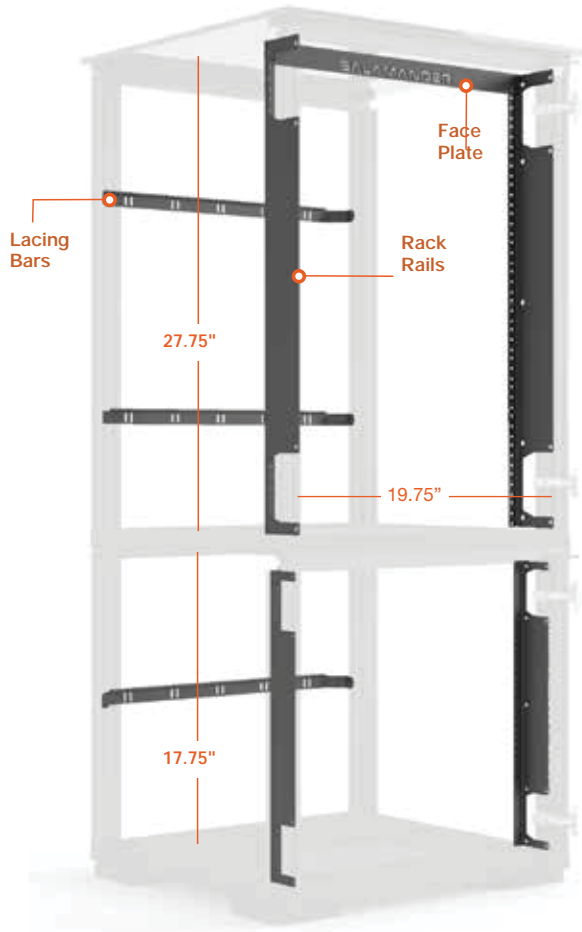

323RM
30 Rack Units
4 Lacing Bars



317RM
15 Rack Units
2 Lacing Bars

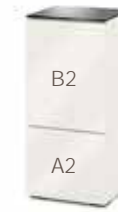

517RM
25 Rack Units
3 Lacing Bars



617RM
30 Rack Units
4 Lacing Bars

A2 19.75"W x 17.75"D x 17.75"H

B2 19.75"W x 19.5"D x 27.75"H

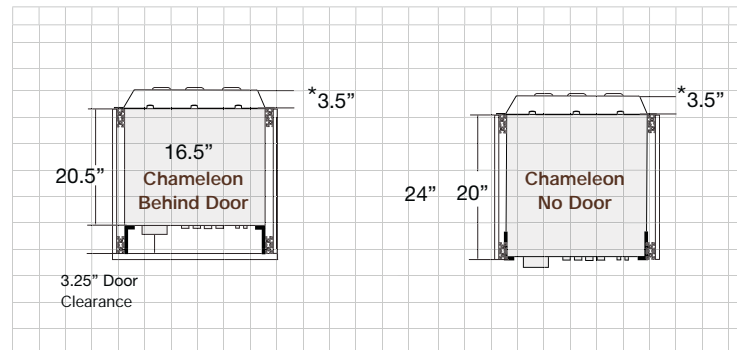

RETRO-FIT RAILS

Choose a dedicated Pro Audio Rack or retro-fit rails (Page 98) with adjustable shelves.





CHAMELEON CORNER AV CABINETS



Accommodating smaller spaces, our Corner Cabinets open up possibilities in a variety of living spaces. Corner Units available in three configurations and all Chameleon Styles.



221 CORNER
Rec. TV Size: up to 50"



323 CORNER
Rec. TV Size: up to 50"



329 CORNER
Rec. TV Size: up to 50"
Includes Speaker Grill

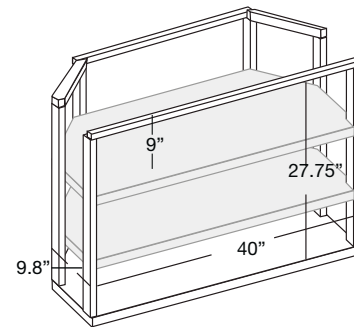
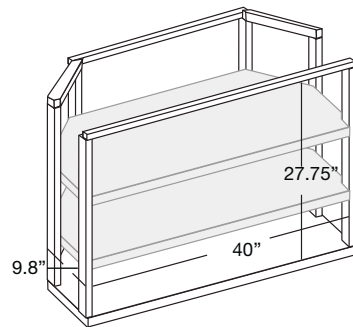
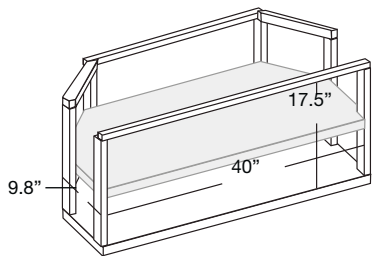

*CORNER INTERIOR

- 40" wide x 10" deep
- 32" wide x 14" deep
- 19" wide x 20" deep

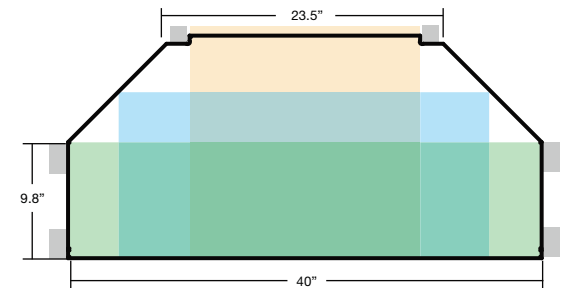

*CORNER EXTERIOR

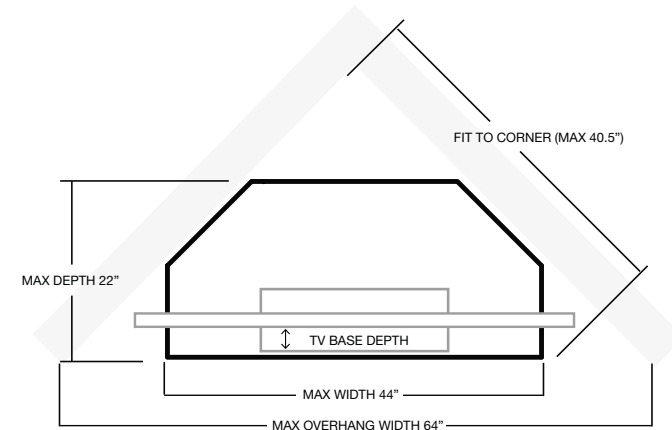

TV SIZING:

For every 1" of depth required by the TV base, subtract 1.8 from 64. This is the MAX TV width at the required depth. Note: Minor gains can be had by moving cabinet forward. This will cause a gap but will produce 1.8" in width per inch moved forward.



CHAMELEON LOW PROFILE AV CABINETS

Low-profile, shallow depth cabinets are sleek, streamlined solutions for supporting AV technology. Our innovative design conceals all equipment and cables, and simple installation allows them to be affixed to any wall without special preparation.

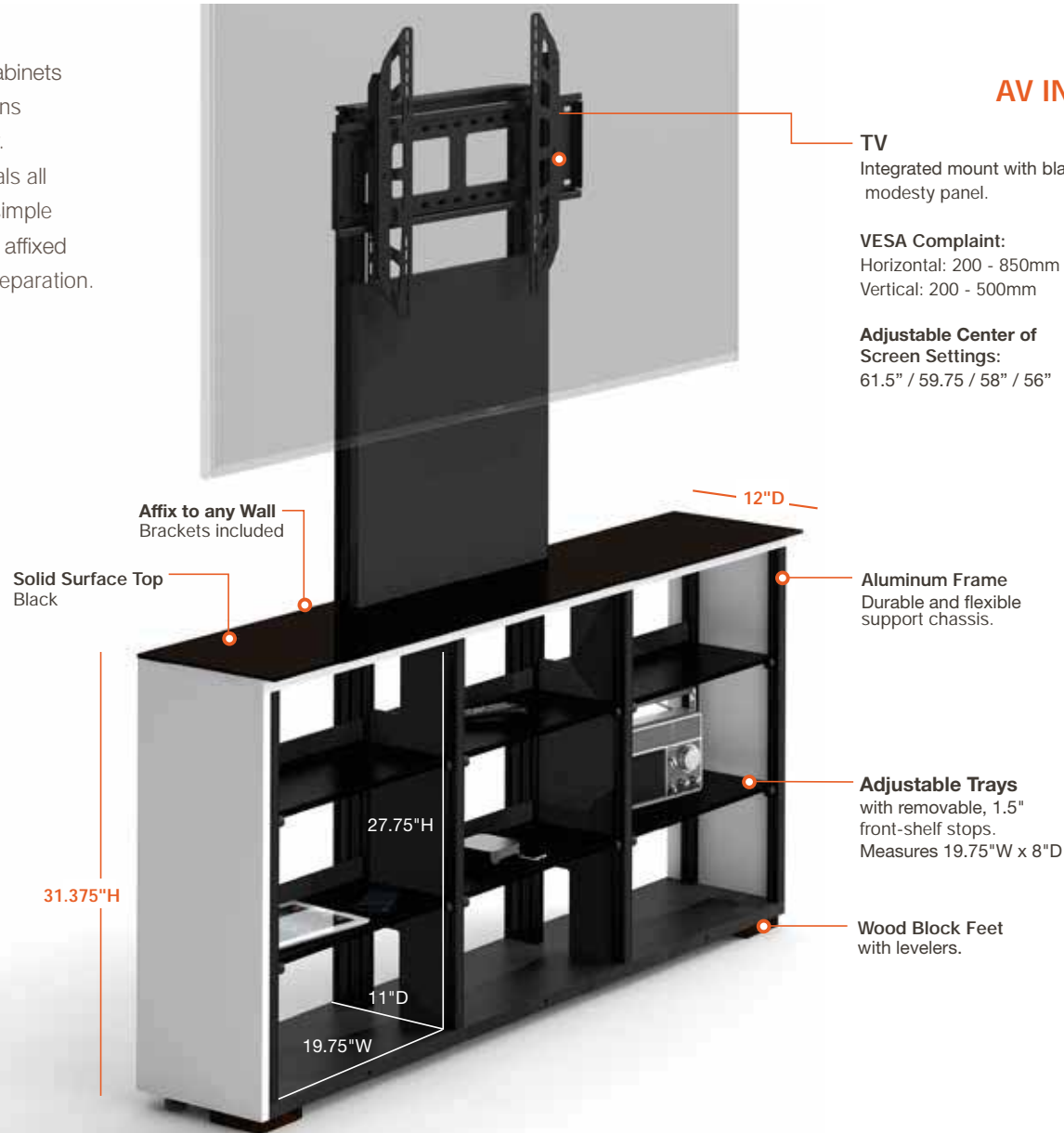

AV INTEGRATION

TV
Integrated mount with black modesty panel.

VESA Complaint:
Horizontal: 200 - 850mm
Vertical: 200 - 500mm

Adjustable Center of Screen Settings:
61.5" / 59.75" / 58" / 56"

Speaker
Model 345 features a center opening with a removable, grill designed to hide a speaker.



See our integrated Premium Soundbars (page 95)

3-U VERTICAL RACK

Optional Vertical Rack mounts (Page 99) to cabinet frame, for industry standard 19"



CHAMELEON LOW PROFILE AV CABINETS

Simple installation. Affix to wall with toggle bolts.

Interior Dimensions

A3 19.75"W x 11"D x 17.75"H

B3 19.75"W x 11"D x 27.75"H

G3 40.5"W x 11"D x 9"H



Low Profile 337

64.75"W x 31.375"H x 12"D



Low Profile 347

88"W x 31.375"H x 12"D



Low Profile 345

88"W x 31.375"H x 12"D

Speaker Compartment: 40"W x 11"D x 9"H



Low Profile 337 With TV Mount

64.75"W x 31.375"H x 12"D

Holds 50-70" TV's, 175 lbs (80kg)



Low Profile 347 With TV Mount

85.5"W x 31.375"H x 12"D

Holds 50-103" TV's, 175 lbs (80kg)



Low Profile 345 with TV Mount

85.5"W x 31.375"H x 12"D

Holds 50-103" TV's, 175 lbs (80kg)

Speaker Compartment: 40"W x 11"D x 9"H



CHAMELEON CUSTOM INTERIORS



STORING

Our personal electronics storage is a great all-in-one organizational space storing remotes and other media devices.

MULTI-FUNCTION

Solidly built, these multi-functional pull-out shelves are specifically designed to support turntables and other heavy equipment.

CHARGING

Conveniently charge and store your mobile devices in our pull-out trays. Now there really is a place for everything.

PRO AUDIO

Cabinets can be outfitted with Rack Mounting Rails that allows integration of professional equipment, conforming to EIA 19" rack standards.

CHAMELEON ACCESSORIES



All of our advanced accessories have been designed to enhance the functional or aesthetic aspects of our furniture systems. Each one has been built to our exacting standards for quality, reliability and durability to provide years of trouble-free operation.



Top Panel Surfaces
choose between tempered glass and solid surface in a variety of colors

Decorator Feet and Wheels
fine tune the style and function

Active Cooling
system protects delicate electronics



Power Conditioning
delivers better picture and sound

IR Repeater allows remote controls to operate through solid doors

Accent Light sets the mood and adds light just where you need it





**BARCELONA
WHITE**



**BARCELONA
BLACK GLASS**



BERLIN



CHICAGO



CORSICA



**DENVER
NATURAL OAK**



**DENVER
NATURAL WALNUT**



ELBA

LOW PROFILE CABINETS - See interior dimensions on page 23.

| | | | | | | | | |
|--|--|--|--|--|--|--|--|--|
| 337 Low-Profile Cabinet | | | C1/BL337/WE 64.75"W x 31.375"H x 12"D | C1/CH337/BO 64.75"W x 31.375"H x 12"D | | C1/DV337/NO 64.75"W x 31.375"H x 12"D | C1/DV337/MW 64.75"W x 31.375"H x 12"D | |
| 337 Low-Profile Cabinet with TV Mount | | | C1/BL337M/WE 64.75"W x 31.375"H x 12"D | C1/CH337M/BO 64.75"W x 31.375"H x 12"D | | C1/DV337M/NO 64.75"W x 31.375"H x 12"D | C1/DV337M/MW 64.75"W x 31.375"H x 12"D | |
| 345 Low-Profile, Wall Cabinet | | | C1/BL345/WE 85.5"W x 31.375"H x 12"D | C1/CH345/BO 85.5"W x 31.375"H x 12"D | | C1/DV345/NO 85.5"W x 31.375"H x 12"D | C1/DV345/MW 85.5"W x 31.375"H x 12"D | |
| 345 Low-Profile Cabinet with TV Mount | | | C1/BL345M/WE 85.5"W x 31.375"H x 12"D | C1/CH345M/BO 85.5"W x 31.375"H x 12"D | | C1/DV345M/NO 85.5"W x 31.375"H x 12"D | C1/DV345M/MW 85.5"W x 31.375"H x 12"D | |
| 347 Low-Profile Cabinet | | | C1/BL347/WE 85.5"W x 31.375"H x 12"D | C1/CH347/BO 85.5"W x 31.375"H x 12"D | | C1/DV347/NO 85.5"W x 31.375"H x 12"D | C1/DV347/MW 85.5"W x 31.375"H x 12"D | |
| 347 Low-Profile Cabinet with TV Mount | | | C1/BL347M/WE 85.5"W x 31.375"H x 12"D | C1/CH347M/BO 85.5"W x 31.375"H x 12"D | | C1/DV347M/NO 85.5"W x 31.375"H x 12"D | C1/DV347M/MW 85.5"W x 31.375"H x 12"D | |

AUDIO & AV CABINET - See interior dimensions on page 17.

| | | | | | | | | |
|--------------------------|--|--|---|---|---|---|---|---|
| 217 Audio Cabinet | C/BA217/NW/GW 24.25"W x 24.75"H x 22"D | C/BA217/NW/BG 24.25"W x 24.75"H x 22"D | C/BL217/WE 23.25"W x 21.5"H x 21.25"D | C/CH217/BO 25.75"W x 22.5"H x 21.25"D | C/CO217/AC 23.25"W x 21.5"H x 21.25"D | C/DV217/NO 23.25"W x 21.5"H x 21.25"D | C/DV217/MW 23.25"W x 21.5"H x 21.25"D | C/EL217/AC 23.25"W x 24.5"H x 21.25"D |
| 317 Audio Cabinet | C/BA317/NW/GW 24.25"W x 34.5"H x 22"D | C/BA317/NW/BG 24.25"W x 34.5"H x 22"D | C/BL317/WE 23.25"W x 31.25"H x 21.25"D | C/CH317/BO 25.75"W x 32"H x 21.25"D | C/CO317/AC 23.25"W x 31.25"H x 21.25"D | C/DV317/NO 23.25"W x 31.25"H x 21.25"D | C/DV317/MW 23.25"W x 31.25"H x 21.25"D | |
| 517 Audio Cabinet | C/BA517/NW/GW 24.25"W x 54.75"H x 22"D | C/BA517/NW/BG 24.25"W x 54.75"H x 22"D | C/BL517/WE 23.25"W x 50.875"H x 21.25"D | C/CH517/BO 25.75"W x 50.875"H x 21.25"D | C/CO517/AC 23.25"W x 50.875"H x 21.25"D | C/DV517/NO 23.25"W x 50.875"H x 21.25"D | C/DV517/MW 23.25"W x 50.875"H x 21.25"D | C/EL517/AC 23.25"W x 53.625"H x 21.25"D |
| 617 Audio Cabinet | C/BA617/NW/GW 24.25"W x 64.5"H x 22"D | C/BA617/NW/BG 24.25"W x 64.5"H x 22"D | C/BL617/WE 23.25"W x 60.625"H x 21.25"D | C/CH617/BO 25.75"W x 60.625"H x 21.25"D | C/CO617/AC 23.25"W x 60.625"H x 21.25"D | C/DV617/NO 23.25"W x 60.625"H x 21.25"D | C/DV617/MW 23.25"W x 60.625"H x 21.25"D | C/EL617/AC 23.25"W x 63.25"H x 21.25"D |
| 221 AV Cabinet | C/BA221/NW/GW 45"W x 24.75"H x 22"D | C/BA221/NW/BG 45"W x 24.75"H x 22"D | C/BL221/WE 44"W x 21.5"H x 21.25"D | C/CH221/BO 46.5"W x 22.5"H x 21.25"D | C/CO221/AC 44"W x 21.5"H x 21.25"D | C/DV221/NO 44"W x 21.5"H x 21.25"D | C/DV221/MW 44"W x 21.5"H x 21.25"D | C/EL221/AC 44"W x 24.5"H x 21.25"D |
| 323 AV Cabinet | C/BA323/NW/GW 45"W x 34.5"H x 22"D | C/BA323/NW/BG 45"W x 34.5"H x 22"D | C/BL323/WE 44"W x 31.375"H x 21.25"D | C/CH323/BO 44"W x 31.375"H x 21.25"D | C/CO323/AC 44"W x 31.25"H x 21.25"D | C/DV323/NO 44"W x 31.375"H x 21.25"D | C/DV323/MW 44"W x 31.375"H x 21.25"D | C/EL323/AC 44"W x 33.75"H x 21.25"D |
| 237 AV Cabinet | C/BA237/NW/GW 65.75"W x 24.75"H x 22"D | C/BA237/NW/BG 65.75"W x 24.75"H x 22"D | C/BL237/WE 64.75"W x 21.5"H x 21.25"D | C/CH237/BO 67.25"W x 22.5"H x 21.25"D | C/CO237/AC 64.75"W x 21.5"H x 21.25"D | C/DV237/NO 64.75"W x 21.5"H x 21.25"D | C/DV237/MW 64.75"W x 21.5"H x 21.25"D | C/EL237/AC 64.75"W x 24.5"H x 21.25"D |
| 247 AV Cabinet | C/BA247/NW/GW 86.5"W x 24.75"H x 22"D | C/BA247/NW/BG 85.5"W x 24.75"H x 22"D | C/BL247/WE 85.5"W x 21.5"H x 21.25"D | C/CH247/BO 88"W x 22.5"H x 21.25"D | C/CO247/AC 85.5"W x 21.5"H x 21.25"D | C/DV247/NO 85.5"W x 21.5"H x 21.25"D | C/DV247/MW 85.5"W x 21.5"H x 21.25"D | C/EL247/AC 85.5"W x 24.5"H x 21.25"D |
| 337 AV Cabinet | C/BA337/NW/GW 65.75"W x 34.5"H x 22"D | C/BA337/NW/BG 65.75"W x 34.5"H x 22"D | C/BL337/WE 64.75"W x 31.375"H x 21.25"D | C/CH337/BO 67.25"W x 32"H x 21.25"D | C/CO337/AC 64.75"W x 31.375"H x 21.25"D | C/DV337/NO 64.75"W x 31.375"H x 21.25"D | C/DV337/MW 64.75"W x 31.375"H x 21.25"D | C/EL337/AC 64.75"W x 33.75"H x 21.25"D |
| 347 AV Cabinet | C/BA347/NW/GW 86.5"W x 34.5"H x 22"D | C/BA347/NW/BG 85.5"W x 34.5"H x 22"D | C/BL347/WE 85.5"W x 31.375"H x 21.25"D | C/CH347/BO 88"W x 32"H x 21.25"D | C/CO347/AC 85.5"W x 31.375"H x 21.25"D | C/DV347/NO 85.5"W x 31.375"H x 21.25"D | C/DV347/MW 85.5"W x 31.375"H x 21.25"D | C/EL347/AC 85.5"W x 33.75"H x 21.25"D |



HAMPTON LANCASTER MIAMI MILAN OLSO SEATTLE SONOMA VENICE ZURICH

| | | | | | | | | |
|---|---|--|--|---|---|---|--|---|
| | C1/LA337/BBO 64.75"W x 31.75"H x 12"D | C1/MM337/GW/BK 64.75"W x 31.375"H x 12"D | | C1/OS337/BG 64.75"W x 31.375"H x 12"D | C1/SE337/GO 64.75"W x 31.375"H x 12"D | | | C1/ZU337/OB 64.75"W x 31.375"H x 12"D |
| | C1/LA337M/BBO 64.75"W x 31.75"H x 12"D | C1/MM337M/GW/BK 64.75"W x 31.375"H x 12"D | | C1/OS337M/BG 64.75"W x 31.375"H x 12"D | C1/SE337M/GO 64.75"W x 31.375"H x 12"D | | | C1/ZU337M/OB 64.75"W x 31.375"H x 12"D |
| | C1/LA345/BBO 85.5"W x 31.75"H x 12"D | C1/MM345/GW/BK 85.5"W x 31.375"H x 12"D | | C1/OS345/BG 85.5"W x 31.375"H x 12"D | C1/SE345/GO 85.5"W x 31.375"H x 12"D | | | C1/ZU345/OB 85.5"W x 31.375"H x 12"D |
| | C1/LA345M/BBO 85.5"W x 31.75"H x 12"D | C1/MM345M/GW/BK 85.5"W x 31.375"H x 12"D | | C1/OS345M/BG 85.5"W x 31.375"H x 12"D | C1/SE345M/GO 85.5"W x 31.375"H x 12"D | | | C1/ZU345M/OB 85.5"W x 31.375"H x 12"D |
| | C1/LA347/BBO 85.5"W x 31.75"H x 12"D | C1/MM347/GW/BK 85.5"W x 31.375"H x 12"D | | C1/OS347/BG 85.5"W x 31.375"H x 12"D | C1/SE347/GO 85.5"W x 31.375"H x 12"D | | | C1/ZU347/OB 85.5"W x 31.375"H x 12"D |
| | C1/LA347M/BBO 85.5"W x 31.75"H x 12"D | C1/MM347M/GW/BK 85.5"W x 31.375"H x 12"D | | C1/OS347M/BG 85.5"W x 31.375"H x 12"D | C1/SE347M/GO 85.5"W x 31.375"H x 12"D | | | C1/ZU347M/OB 85.5"W x 31.375"H x 12"D |
| | C/LA217/BBO 23.25"W x 21.75"H x 21.25"D | C/MM217/GW/BK 23.25"W x 21.5"H x 21.25"D | C/ML217/WH/BK 23.25"W x 21.5"H x 21.25"D | C/OS217/BG 23.25"W x 21.5"H x 21.25"D | C/SE217/GO 23.25"W x 21.5"H x 21.25"D | C/SO217/AC 23.25"W x 24.5"H x 21.25"D | | C/ZU217/OB 23.25"W x 21.5"H x 21.25"D |
| | C/LA317/BBO 23.25"W x 31.75"H x 21.25"D | C/MM317/GW/BK 23.25"W x 31.25"H x 21.25"D | C/ML317/WH/BK 23.25"W x 31.25"H x 21.25"D | C/OS317/BG 23.25"W x 31.25"H x 21.25"D | C/SE317/GO 23.25"W x 31.25"H x 21.25"D | C/SO317/AC 23.25"W x 33.75"H x 21.25"D | | C/ZU317/OB 23.25"W x 31.25"H x 21.25"D |
| | C/LA517/BBO 23.25"W x 51.25"H x 21.25"D | C/MM517/GW/BK 23.25"W x 50.875"H x 21.25"D | C/ML517/WH/BK 23.25"W x 50.875"H x 21.25"D | C/OS517/BG 23.25"W x 50.875"H x 21.25"D | C/SE517/GO 23.25"W x 50.875"H x 21.25"D | C/SO517/AC 23.25"W x 53.625"H x 21.25"D | | C/ZU517/OB 23.25"W x 50.875"H x 21.25"D |
| | C/LA617/BBO 23.25"W x 61"H x 21.25"D | C/MM617/GW/BK 23.25"W x 60.625"H x 21.25"D | C/ML617/WH/BK 23.25"W x 60.625"H x 21.25"D | C/OS617/BG 23.25"W x 60.625"H x 21.25"D | C/SE617/GO 23.25"W x 60.625"H x 21.25"D | C/SO617/AC 23.25"W x 63.25"H x 21.25"D | | C/ZU617/OB 23.25"W x 60.625"H x 21.25"D |
| C/HA221/DB 45.25"W x 24.5"H x 21.75"D | C/LA221/BBO 44"W x 21.75"H x 21.25"D | C/MM221/GW/BK 44"W x 21.5"H x 21.25"D | C/ML221/WH/BK 44"W x 21.5"H x 21.25"D | C/OS221/BG 44"W x 21.5"H x 21.25"D | C/SE221/GO 44"W x 21.5"H x 21.25"D | C/SO221/AC 44"W x 24.5"H x 21.25"D | | C/ZU221/OB 44"W x 21.5"H x 21.25"D |
| | C/LA323/BBO 44"W x 31.75"H x 21.25"D | C/MM323/GW/BK 44"W x 31.375"H x 21.25"D | C/ML323/WH/BK 44"W x 31.375"H x 21.25"D | C/OS323/BG 44"W x 31.375"H x 21.25"D | C/SE323/GO 44"W x 31.375"H x 21.25"D | C/SO323/AC 44"W x 33.75"H x 21.25"D | | C/ZU323/OB 44"W x 31.375"H x 21.25"D |
| C/HA237/DB 66"W x 24.5"H x 21.75"D | C/LA237/BBO 64.75"W x 21.75"H x 21.25"D | C/MM237/GW/BK 64.75"W x 21.5"H x 21.25"D | C/ML237/WH/BK 64.75"W x 21.5"H x 21.25"D | C/OS237/BG 64.75"W x 21.5"H x 21.25"D | C/SE237/GO 64.75"W x 21.5"H x 21.25"D | C/SO237/AC 64.75"W x 24.5"H x 21.25"D | | C/ZU237/OB 64.75"W x 21.5"H x 21.25"D |
| | C/LA247/BBO 85.5"W x 21.88"H x 21.25"D | C/MM247/GW/BK 85.5"W x 21.5"H x 21.25"D | C/ML247/WH/BK 85.5"W x 21.5"H x 21.25"D | C/OS247/BG 85.5"W x 21.5"H x 21.25"D | C/SE247/GO 85.5"W x 21.5"H x 21.25"D | C/SO247/AC 85.5"W x 24.5"H x 21.25"D | | C/ZU247/OB 85.5"W x 21.5"H x 21.25"D |
| | C/LA337/BBO 64.75"W x 31.75"H x 21.25"D | C/MM337/GW/BK 64.75"W x 31.375"H x 21.25"D | C/ML337/WH/BK 64.75"W x 31.375"H x 21.25"D | C/OS337/BG 64.75"W x 31.375"H x 21.25"D | C/SE337/GO 64.75"W x 31.375"H x 21.25"D | C/SO337/AC 64.75"W x 33.75"H x 21.25"D | | C/ZU337/OB 64.75"W x 31.375"H x 21.25"D |
| | C/LA347/BBO 85.5"W x 31.75"H x 21.25"D | C/MM347/GW/BK 85.5"W x 31.375"H x 21.25"D | C/ML347/WH/BK 85.5"W x 31.375"H x 21.25"D | C/OS347/BG 85.5"W x 31.375"H x 21.25"D | C/SE347/GO 85.5"W x 31.375"H x 21.25"D | C/SO347/AC 85.5"W x 33.75"H x 21.25"D | | C/ZU347/OB 85.5"W x 31.375"H x 21.25"D |



**BARCELONA
WHITE**



**BARCELONA
BLACK GLASS**



BERLIN



CHICAGO



CORSICA



**DENVER
NATURAL OAK**



**DENVER
NATURAL WALNUT**



ELBA

SPEAKER INTEGRATED AV CABINETS - See interior dimensions on page 17.

| | | | | | | | | |
|--------------------------------|---|---|---|---|---|---|---|---|
| 217 Subwoofer Enclosure | C/BA217SE/NW/GW 24.25"W x 24.25"H x 21.25"D | C/BA217SE/NW/BG 24.25"W x 24.25"H x 21.25"D | C/BL217SE/WE 23.25"W x 21.5"H x 21.25"D | C/CH217SE/BO 23.25"W x 21.5"H x 21.25"D | C/CO217SE/AC 25.75"W x 22.5"H x 21.25"D | C/DV217SE/NO 23.25"W x 21.5"H x 21.25"D | C/DV217SE/MW 23.25"W x 21.5"H x 21.25"D | C/EL217SE/AC 23.25"W x 24.5"H x 21.25"D |
| 236 AV Cabinet | C/BA236/NW/GW 65.75"W x 24.25"H x 21.25"D | C/BA236/NW/BG 65.75"W x 24.25"H x 21.25"D | C/BL236/WE 64.75"W x 21.5"H x 21.25"D | C/CH236/BO 64.75"W x 21.5"H x 21.25"D | C/CO236/AC 67.25"W x 22.5"H x 21.25"D | C/DV236/NO 64.75"W x 21.5"H x 21.25"D | C/DV236/MW 64.75"W x 21.5"H x 21.25"D | C/EL236/AC 64.75"W x 24.5"H x 21.25"D |
| 245 AV Cabinet | C/BA245/NW/GW 86.5"W x 24.25"H x 21.25"D | C/BA245/NW/BG 86.5"W x 24.25"H x 21.25"D | C/BL245/WE 85.5"W x 21.5"H x 21.25"D | C/CH245/BO 85.5"W x 21.5"H x 21.25"D | C/CO245/AC 88"W x 22.5"H x 21.25"D | C/DV245/NO 85.5"W x 21.5"H x 21.25"D | C/DV245/MW 85.5"W x 21.5"H x 21.25"D | C/EL245/AC 85.5"W x 24.5"H x 21.25"D |
| 329 AV Cabinet | C/BA329/NW/GW 45"W x 34.5"H x 21.25"D | C/BA329/NW/BG 45"W x 34.5"H x 21.25"D | C/BL329/WE 44"W x 31.25"H x 21.25"D | C/CH329/BO 44"W x 31.25"H x 21.25"D | C/CO329/AC 46.5"W x 32"H x 21.25"D | C/DV329/NO 44"W x 31.25"H x 21.25"D | C/DV329/MW 44"W x 31.25"H x 21.25"D | C/EL329/AC 44"W x 33.75"H x 21.25"D |
| 336 AV Cabinet | C/BA336/NW/GW 65.75"W x 34.5"H x 21.25"D | C/BA336/NW/BG 65.75"W x 34.5"H x 21.25"D | C/BL336/WE 64.75"W x 31.25"H x 21.25"D | C/CH336/BO 64.75"W x 31.25"H x 21.25"D | C/CO336/AC 67.25"W x 32"H x 21.25"D | C/DV336/NO 64.75"W x 31.25"H x 21.25"D | C/DV336/MW 64.75"W x 31.25"H x 21.25"D | C/EL336/AC 64.75"W x 33.75"H x 21.25"D |
| 339 AV Cabinet | C/BA339/NW/GW 65.75"W x 34.5"H x 21.25"D | C/BA339/NW/BG 65.75"W x 34.5"H x 21.25"D | C/BL339/WE 64.75"W x 31.25"H x 21.25"D | C/CH339/BO 64.75"W x 31.25"H x 21.25"D | C/CO339/AC 67.25"W x 32"H x 21.25"D | C/DV339/NO 64.75"W x 31.25"H x 21.25"D | C/DV339/MW 64.75"W x 31.25"H x 21.25"D | C/EL339/AC 64.75"W x 33.75"H x 21.25"D |
| 345 AV Cabinet | C/BA345/NW/GW 86.5"W x 34.5"H x 21.25"D | C/BA345/NW/BG 86.5"W x 34.5"H x 21.25"D | C/BL345/WE 85.5"W x 31.25"H x 21.25"D | C/CH345/BO 85.5"W x 31.25"H x 21.25"D | C/CO345/AC 88"W x 32"H x 21.25"D | C/DV345/NO 85.5"W x 31.25"H x 21.25"D | C/DV345/MW 85.5"W x 31.25"H x 21.25"D | C/EL345/AC 85.5"W x 33.75"H x 21.25"D |

CORNER & AV CABINETS - See interior dimensions on page 21.

| | | | | | | | | |
|------------------------------|--|--|---|---|---|---|---|---|
| 221 Corner AV Cabinet | C/BA221CR/NW/GW 45"W x 24.25"H x 21.25"D | C/BA221CR/NW/BG 45"W x 24.25"H x 21.25"D | C/BL221CR/WE 44"W x 21.5"H x 21.25"D | C/CH221CR/BO 44"W x 21.5"H x 21.25"D | C/CO221CR/AC 46.5"W x 22.5"H x 21.25"D | C/DV221CR/NO 44"W x 21.5"H x 21.25"D | C/DV221CR/MW 44"W x 21.5"H x 21.25"D | C/EL221CR/AC 44"W x 24.5"H x 21.25"D |
| 323 Corner AV Cabinet | C/BA323CR/NW/GW 45"W x 34.5"H x 21.25"D | C/BA323CR/NW/BG 45"W x 34.5"H x 21.25"D | C/BL323CR/WE 44"W x 31.25"H x 21.25"D | C/CH323CR/BO 44"W x 31.25"H x 21.25"D | C/CO323CR/AC 46.5"W x 32"H x 21.25"D | C/DV323CR/NO 44"W x 31.25"H x 21.25"D | C/DV323CR/MW 44"W x 31.25"H x 21.25"D | C/EL323CR/AC 44"W x 33.75"H x 21.25"D |
| 329 Corner AV Cabinet | C/BA329CR/NW/GW 45"W x 34.5"H x 21.25"D | C/BA329CR/NW/BG 45"W x 34.5"H x 21.25"D | C/BL329CR/WE 44"W x 31.25"H x 21.25"D | C/CH329CR/BO 44"W x 31.25"H x 21.25"D | C/CO329CR/AC 46.5"W x 31.25"H x 21.25"D | C/DV329CR/NO 44"W x 31.25"H x 21.25"D | C/DV329CR/MW 44"W x 31.25"H x 21.25"D | C/EL329CR/AC 44"W x 33.75"H x 21.25"D |

PRO AUDIO RACK - See interior dimensions on page 20.

| | | | | | | | | |
|---------------------------|--|--|---|---|--|---|---|---|
| 317 Pro Audio Rack | C/BA317RM/NW/GW 24.25"W x 34.5"H x 21.25"D | C/BA317RM/NW/BG 24.25"W x 34.5"H x 21.25"D | C/BL317RM/WE 23.25"W x 31.25"H x 21.25"D | C/CH317RM/BO 23.25"W x 31.25"H x 21.25"D | C/CO317RM/AC 25.75"W x 32"H x 21.25"D | C/DV317RM/NO 23.25"W x 31.25"H x 21.25"D | C/DV317RM/MW 23.25"W x 31.25"H x 21.25"D | C/EL317RM/AC 23.25"W x 33.75"H x 21.25"D |
| 323 Pro Audio Rack | C/BA323RM/NW/GW 45"W x 34.5"H x 21.25"D | C/BA323RM/NW/BG 45"W x 34.5"H x 21.25"D | C/BL323RM/WE 44"W x 31.25"H x 21.25"D | C/CH323RM/BO 44"W x 31.25"H x 21.25"D | C/CO323RM/AC 46.5"W x 32"H x 21.25"D | C/DV323RM/NO 44"W x 31.25"H x 21.25"D | C/DV323RM/MW 44"W x 31.25"H x 21.25"D | C/EL323RM/AC 44"W x 33.75"H x 21.25"D |
| 517 Pro Audio Rack | C/BA517RM/NW/GW 24.25"W x 54.5"H x 21.25"D | C/BA517RM/NW/BG 24.25"W x 54.5"H x 21.25"D | C/BL517RM/WE 23.25"W x 50.875"H x 21.25"D | C/CH517RM/BO 23.25"W x 50.875"H x 21.25"D | C/CO517RM/AC 25.75"W x 51.75"H x 21.25"D | C/DV517RM/NO 23.25"W x 50.875"H x 21.25"D | C/DV517RM/MW 23.25"W x 50.875"H x 21.25"D | C/EL517RM/AC 23.25"W x 53.625"H x 21.25"D |
| 617 Pro Audio Rack | C/BA617RM/NW/GW 24.25"W x 64.5"H x 21.25"D | C/BA617RM/NW/BG 24.25"W x 64.5"H x 21.25"D | C/BL617RM/WE 23.25"W x 60.625"H x 21.25"D | C/CH617RM/BO 23.25"W x 60.625"H x 21.25"D | C/CO617RM/AC 25.75"W x 61.25"H x 21.25"D | C/DV617RM/NO 23.25"W x 60.625"H x 21.25"D | C/DV617RM/MW 23.25"W x 60.625"H x 21.25"D | C/EL617RM/AC 23.25"W x 63.25"H x 21.25"D |



HAMPTON

LANCASTER

MIAMI

MILAN

OLSO

SEATTLE

SONOMA

VENICE

ZURICH

| | | | | | | | | |
|---|---|--|--|---|---|---|--|---|
| | C/LA217SE/BBO 23.25"W x 21.75"H x 21.25"D | C/MM217SE/GW/BK 23.25"W x 21.5"H x 21.25"D | C/ML217SE/WH/BK 23.25"W x 21.5"H x 21.25"D | C/OS217SE/BG 23.25"W x 21.5"H x 21.25"D | C/SE217SE/GO 23.25"W x 21.5"H x 21.25"D | C/SO217SE/AC 23.25"W x 24.5"H x 21.25"D | | C/ZU217SE/OB 23.25"W x 21.5"H x 21.25"D |
| C/HA236/DB 66"W x 24.5"H x 21.25"D | C/LA236/BBO 64.75"W x 21.75"H x 21.25"D | C/MM236/GW/BK 64.75"W x 21.5"H x 21.25"D | C/ML236/WH/BK 64.75"W x 21.5"H x 21.25"D | C/OS236/BG 64.75"W x 21.5"H x 21.25"D | C/SE236/GO 64.75"W x 21.5"H x 21.25"D | C/SO236/AC 64.75"W x 24.5"H x 21.25"D | | C/ZU236/OB 64.75"W x 21.5"H x 21.25"D |
| | C/LA245/BBO 85.5"W x 21.75"H x 21.25"D | C/MM245/GW/BK 85.5"W x 21.5"H x 21.25"D | C/ML245/WH/BK 85.5"W x 21.5"H x 21.25"D | C/OS245/BG 85.5"W x 21.5"H x 21.25"D | C/SE245/GO 85.5"W x 21.5"H x 21.25"D | C/SO245/AC 85.5"W x 24.5"H x 21.25"D | | C/ZU245/OB 85.5"W x 21.5"H x 21.25"D |
| | C/LA329/BBO 44"W x 31.75"H x 21.25"D | C/MM329/GW/BK 44"W x 31.25"H x 21.25"D | C/ML329/WH/BK 44"W x 31.25"H x 21.25"D | C/OS329/BG 44"W x 31.25"H x 21.25"D | C/SE329/GO 44"W x 31.25"H x 21.25"D | C/SO329/AC 44"W x 33.75"H x 21.25"D | C/VE329/CA 45.25"W x 33.25"H x 21.75"D | C/ZU329/OB 44"W x 31.25"H x 21.25"D |
| | C/LA336/BBO 64.75"W x 31.75"H x 21.25"D | C/MM336/GW/BK 64.75"W x 31.25"H x 21.25"D | C/ML336/WH/BK 64.75"W x 31.25"H x 21.25"D | C/OS336/BG 64.75"W x 31.25"H x 21.25"D | C/SE336/GO 64.75"W x 31.25"H x 21.25"D | C/SO336/AC 64.75"W x 33.75"H x 21.25"D | | C/ZU336/OB 64.75"W x 31.25"H x 21.25"D |
| | C/LA339/BBO 64.75"W x 31.75"H x 21.25"D | C/MM339/GW/BK 64.75"W x 31.25"H x 21.25"D | C/ML339/WH/BK 64.75"W x 31.25"H x 21.25"D | C/OS339/BG 64.75"W x 31.25"H x 21.25"D | C/SE339/GO 64.75"W x 31.25"H x 21.25"D | C/SO339/AC 64.75"W x 33.75"H x 21.25"D | C/VE339/CA 66"W x 33.25"H x 21.75"D | C/ZU339/OB 64.75"W x 31.25"H x 21.25"D |
| | C/LA345/BBO 85.5"W x 31.75"H x 21.25"D | C/MM345/GW/BK 85.5"W x 31.25"H x 21.25"D | C/ML345/WH/BK 85.5"W x 31.25"H x 21.25"D | C/OS345/BG 85.5"W x 31.25"H x 21.25"D | C/SE345/GO 85.5"W x 31.25"H x 21.25"D | C/SO345/AC 85.5"W x 33.75"H x 21.25"D | | C/ZU345/OB 85.5"W x 31.25"H x 21.25"D |
| C/HA221CR/DB 45.25"W x 24.5"H x 21.25"D | C/LA221CR/BBO 44"W x 21.75"H x 21.25"D | C/MM221CR/GW/BK 44"W x 21.5"H x 21.25"D | C/ML221CR/WH/BK 44"W x 21.5"H x 21.25"D | C/OS221CR/BG 44"W x 21.5"H x 21.25"D | C/SE221CR/GO 44"W x 21.5"H x 21.25"D | C/SO221CR/AC 44"W x 24.5"H x 21.25"D | C/VE221CR/CA 45.25"W x 24"H x 21.75"D | C/ZU221CR/OB 44"W x 21.5"H x 21.25"D |
| | C/LA323CR/BBO 44"W x 31.75"H x 21.25"D | C/MM323CR/GW/BK 44"W x 31.25"H x 21.25"D | C/ML323CR/WH/BK 44"W x 31.25"H x 21.25"D | C/OS323CR/BG 44"W x 31.25"H x 21.25"D | C/SE323CR/GO 44"W x 31.25"H x 21.25"D | C/SO323CR/AC 44"W x 33.75"H x 21.25"D | C/VE323CR/CA 45.25"W x 33.25"H x 21.75"D | C/ZU323CR/OB 44"W x 31.25"H x 21.25"D |
| | C/LA329CR/BBO 44"W x 31.75"H x 21.25"D | C/MM329CR/GW/BK 44"W x 31.25"H x 21.25"D | C/ML329CR/WH/BK 44"W x 31.25"H x 21.25"D | C/OS329CR/BG 44"W x 31.25"H x 21.25"D | C/SE329CR/GO 44"W x 31.25"H x 21.25"D | C/SO329CR/AC 44"W x 33.75"H x 21.25"D | C/VE329CR/CA 45.25"W x 33.25"H x 21.75"D | C/ZU329CR/OB 44"W x 31.25"H x 21.25"D |
| | C/LA317RM/BBO 23.25"W x 31.75"H x 21.25"D | C/MM317RM/GW/BK 23.25"W x 31.25"H x 21.25"D | C/ML317RM/WH/BK 23.25"W x 31.25"H x 21.25"D | C/OS317RM/BG 23.25"W x 31.25"H x 21.25"D | C/SE317RM/GO 23.25"W x 31.25"H x 21.25"D | C/SO317RM/AC 23.25"W x 33.75"H x 21.25"D | | C/ZU317RM/OB 23.25"W x 31.25"H x 21.25"D |
| | C/LA323RM/BBO 44"W x 31.75"H x 21.25"D | C/MM323RM/GW/BK 44"W x 31.25"H x 21.25"D | C/ML323RM/WH/BK 44"W x 31.25"H x 21.25"D | C/OS323RM/BG 44"W x 31.25"H x 21.25"D | C/SE323RM/GO 44"W x 31.25"H x 21.25"D | C/SO323RM/AC 44"W x 33.75"H x 21.25"D | C/VE323RM/CA 45.25"W x 33.25"H x 21.75"D | C/ZU323RM/OB 44"W x 31.25"H x 21.25"D |
| | C/LA517RM/BBO 23.25"W x 51.25"H x 21.25"D | C/MM517RM/GW/BK 23.25"W x 50.875"H x 21.25"D | C/ML517RM/WH/BK 23.25"W x 50.875"H x 21.25"D | C/OS517RM/BG 23.25"W x 50.875"H x 21.25"D | C/SE517RM/GO 23.25"W x 50.875"H x 21.25"D | C/SO517RM/AC 23.25"W x 53.625"H x 21.25"D | | C/ZU517RM/OB 23.25"W x 50.875"H x 21.25"D |
| | C/LA617RM/BBO 23.25"W x 61"H x 21.25"D | C/MM617RM/GW/BK 23.25"W x 60.625"H x 21.25"D | C/ML617RM/WH/BK 23.25"W x 60.625"H x 21.25"D | C/OS617RM/BG 23.25"W x 60.625"H x 21.25"D | C/SE617RM/GO 23.25"W x 60.625"H x 21.25"D | C/SO617RM/AC 23.25"W x 63.25"H x 21.25"D | | C/ZU617RM/OB 23.25"W x 60.625"H x 21.25"D |



BERLIN



CHICAGO



**DENVER
NATURAL OAK**



**DENVER
NATURAL WALNUT**



MIAMI

PROJECTOR CABINETS

| | | | | | |
|------------------------------------|--|--|--|--|---|
| Epson LS100 | X/EPS237BL/WE 64.75"W x 22.79"H x 21.28"D | X/EPS237CH/BO 64.75"W x 22.79"H x 21.28"D | X/EPS237DV/NO 64.75"W x 22.79"H x 21.28"D | X/EPS237DV/MW 64.75"W x 22.79"H x 21.28"D | X/EPS237MM/GW/BK 64.75"W x 22.79"H x 21.28"D |
| Vivitek DH765Z-UST, DW763Z-UST, | X/VIV237BL/WE 64.75"W x 21.5"H x 21.28"D | X/VIV237CH/BO 64.75"W x 21.5"H x 21.28"D | X/VIV237DV/NO 64.75"W x 21.5"H x 21.28"D | X/VIV237DV/MW 64.75"W x 21.5"H x 21.28"D | X/VIV237MM/GW/BK 64.75"W x 21.5"H x 21.28"D |

PROJECTOR CABINETS - SINGLE SPEAKER GRILL

| | | | | | |
|--------------------------------------|--|--|--|--|---|
| Epson LS100 | X/EPS236BL/WE 64.75"W x 22.79"H x 21.28"D | X/EPS236CH/BO 64.75"W x 22.79"H x 21.28"D | X/EPS236DV/NO 64.75"W x 22.79"H x 21.28"D | X/EPS236DV/MW 64.75"W x 22.79"H x 21.28"D | X/EPS236MM/GW/BK 64.75"W x 22.79"H x 21.28"D |
| Hisense 100L8E | X/HSE245BL/WE 85.5"W x 21.28"H x 21.28"D | X/HSE245CH/BO 85.5"W x 21.28"H x 21.28"D | X/HSE245DV/NO 85.5"W x 21.28"H x 21.28"D | X/HSE245DV/MW 85.5"W x 21.28"H x 21.28"D | X/HSE245MM/GW/BK 85.5"W x 21.28"H x 21.28"D |
| Hisense 100L10E, 120L10E, 150L10E | X/HSE10/245BL/WE 85.5"W x 21.28"H x 21.28"D | X/HSE10/245CH/BO 85.5"W x 21.28"H x 21.28"D | X/HSE10/245DV/NO 85.5"W x 21.28"H x 21.28"D | X/HSE10/245DV/MW 85.5"W x 21.28"H x 21.28"D | X/HSE10/245MM/GW/BK 85.5"W x 21.28"H x 21.28"D |
| LG LGHU85LA | | X/LG1/245BO/BK 85.5"W x 21.3"H x 21.25"D | | | X/LG1/245GW/BK 85.5"W x 21.3"H x 21.25"D |
| | | | | | X/LG1/229GW/BK 44"W x 21.3"H x 21.25"D |
| Vivitek DH765Z-UST, DW763Z-UST | X/VIV236BL/WE 64.75"W x 21.5"H x 21.28"D | X/VIV236CH/BO 64.75"W x 21.5"H x 21.28"D | X/VIV236DV/NO 64.75"W x 21.5"H x 21.28"D | X/VIV236DV/MW 64.75"W x 21.5"H x 21.28"D | X/VIV236MM/GW/BK 64.75"W x 21.5"H x 21.28"D |

PROJECTOR CABINETS - DUAL SPEAKER GRILL

| | | | | | |
|------------------|--|---|--|--|--|
| Sony VPLVZ1000ES | | X/SNY245SCH/BO 85.5"W x 21.5"H x 21.28"D | | | X/SNY245MM/GW/BK/BK 85.5"W x 21.5"H x 21.28"D |
| LG LGHU85LA | | X/LG1/245S/BO/BK 85.5"W x 21.3"H x 21.25"D | | | X/LG1/245S/GW/BK 85.5"W x 21.3"H x 21.25"D |
| | | | | | X/LG1/229S/GW/BK 44"W x 21.3"H x 21.25"D |



MILAN



OLSO



SIENA



SEATTLE



ZURICH

| | | | | |
|--|--|---|--|--|
| X/EPS237ML/BK 64.75"W x 22.79"H x 21.28"D | X/EPS237OS/BG 64.75"W x 22.79"H x 21.28"D | | X/EPS237SE/GO 64.75"W x 22.79"H x 21.28"D | X/EPS237ZU/OB 64.75"W x 22.79"H x 21.28"D |
| X/VIV237ML/BK 64.75"W x 21.5"H x 21.28"D | X/VIV237OS/BG 64.75"W x 21.5"H x 21.28"D | | X/VIV237SE/GO 64.75"W x 21.5"H x 21.28"D | X/VIV237ZU/OB 44"W x 31.25"H x 21.25"D |
| X/EPS236ML/BK 64.75"W x 22.79"H x 21.28"D | X/EPS236OS/BG 64.75"W x 22.79"H x 21.28"D | | X/EPS236SE/GO 64.75"W x 22.79"H x 21.28"D | X/EPS236ZU/OB 64.75"W x 22.79"H x 21.28"D |
| X/HSE245ML/BK 85.5"W x 21.28"H x 21.28"D | X/HSE245OS/BG 85.5"W x 21.28"H x 21.28"D | | X/HSE245SE/GO 85.5"W x 21.28"H x 21.28"D | X/HSE245ZU/OB 85.5"W x 21.28"H x 21.28"D |
| X/HSE10/245ML/BK 85.5"W x 21.28"H x 21.28"D | X/HSE10/245OS/BG 85.5"W x 21.28"H x 21.28"D | | X/HSE10/245SE/GO 85.5"W x 21.28"H x 21.28"D | X/HSE10/245ZU/OB 85.5"W x 21.28"H x 21.28"D |
| | X/LG1/245 85.5"W x 21.3"H x 21.25"D | | | |
| | | X/LG1/229BO/BK 44"W x 21.3"H x 21.25"D | | |
| X/VIV236ML/BK 64.75"W x 21.5"H x 21.28"D | X/VIV236OS/BG 64.75"W x 21.5"H x 21.28"D | | X/VIV236SE/GO 85.5"W x 21.5"H x 21.28"D | X/VIV236ZU/OB 64.75"W x 21.5"H x 21.28"D |
| | X/SNY245OS/BG 85.5"W x 21.5"H x 21.28"D | | | |
| | X/LG1/245S/BO/BG 85.5"W x 21.3"H x 21.25"D | | | |
| | | X/LG1/229S/BO/BK 44"W x 21.3"H x 21.25"D | | |

built on



Triple-Width 237

BARCELONA

NATURAL WALNUT, WHITE

Clean, cutting-edge design with bevelled edges and precision miter joints.



Gloss White Doors

Brown Speaker Grill
(Models 329, 236, 336 & 339)

Mitered Edges



217
Audio Cabinet
Subwoofer Enclosure



317
Audio Cabinet
Pro Audio Rack



517
Audio Cabinet
Pro Audio Rack



617
Audio Cabinet
Pro Audio Rack



221
AV Cabinet
Corner Cabinet



323
AV Cabinet
Pro Audio Rack
Corner Cabinet



329 - Speaker Integration
AV Cabinet
Corner Cabinet



236 - Speaker Integration
AV Cabinet



237
AV Cabinet



337
AV Cabinet



336 - Speaker Integration
AV Cabinet



339 - Speaker Integration
AV Cabinet



247
AV Cabinet



347
AV Cabinet



245 - Speaker Integration
AV Cabinet



345 - Speaker Integration
AV Cabinet

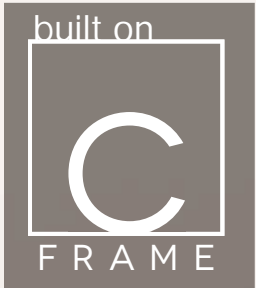

BARCELONA

NATURAL WALNUT, BLACK GLASS

Clean, cutting-edge design with bevelled edges and precision miter joints.





BARCELONA

NATURAL WALNUT / BLACK GLASS

See Models & Dimensions on pages 26-31



Black Glass Doors

Black Speaker Grill
(Models 329, 236, 336 & 339)

Mitered Edges



217
Audio Cabinet
Subwoofer Enclosure



317
Audio Cabinet
Pro Audio Rack



517
Audio Cabinet
Pro Audio Rack



617
Audio Cabinet
Pro Audio Rack



221
AV Cabinet
Corner Cabinet



323
AV Cabinet
Pro Audio Rack
Corner Cabinet



329 - Speaker Integration
AV Cabinet
Corner Cabinet



236 - Speaker Integration
AV Cabinet



237
AV Cabinet



337
AV Cabinet



336 - Speaker Integration
AV Cabinet



339 - Speaker Integration
AV Cabinet



247
AV Cabinet



347
AV Cabinet



245 - Speaker Integration
AV Cabinet



345 - Speaker Integration
AV Cabinet

Quad-Width 247 On-Wall
(Wall Kit Sold Separately)



BERLIN

WENGÉ, WAVE TEXTURE, BLACK GLASS

A distinctly European influence with its wave textured front.



***MULTIPLE TOP
OPTIONS AVAILABLE
CALL FOR DETAILS**

*Black Glass top
comes standard*

Custom fee will apply



Solid Surface,
Matte Black

*Black Glass



236 - Projector and Speaker Integration
Epson and Vivitek models



237 - Projector Integration
Vivitek and Epson models



245 - Projector Integration
Hisense



217
Audio Cabinet
Subwoofer Enclosure



317
Audio Cabinet
Pro Audio Rack



517
Audio Cabinet
Pro Audio Rack



617
Audio Cabinet
Pro Audio Rack



221
AV Cabinet (Wall Mountable)
Corner Cabinet



323
AV Cabinet
Pro Audio Rack
Corner Cabinet



329 - Speaker Integration
AV Cabinet
Corner Cabinet



236 - Speaker Integration
AV Cabinet (Wall Mountable)



237
AV Cabinet (Wall Mountable)



337
AV Cabinet
Low Profile Cabinet



336 - Speaker Integration
AV Cabinet



339 - Speaker Integration
AV Cabinet



247
AV Cabinet (Wall Mountable)



347
AV Cabinet
Low Profile Cabinet



245 - Speaker Integration
AV Cabinet (Wall Mountable)



345 - Speaker Integration
AV Cabinet
Low Profile Cabinet

Quad-Width 245 On-Wall
(Wall Kit Sold Separately)



CHICAGO

BLACK OAK, GRASS TEXTURE, GLASS TOP

Black Oak finish with Tall Grass Texture & Black Glass top.



***MULTIPLE TOP
OPTIONS AVAILABLE
CALL FOR DETAILS**

*Black Glass top
comes standard*

Custom fee will apply



Solid Surface - Matte Black

*Glass - Black



CHICAGO

BLACK OAK, GRASS TEXTURE

See Models & Dimensions on pages 26-31



236 - Projector and Speaker Integration
Epson and Vivitek models



237 - Projector Integration
Vivitek and Epson models



245 - Projector and Speaker Integration
Sony and Hisense models



217
Audio Cabinet
Subwoofer Enclosure



317
Audio Cabinet
Pro Audio Rack



517
Audio Cabinet
Pro Audio Rack



617
Audio Cabinet
Pro Audio Rack



221
AV Cabinet (Wall Mountable)
Corner Cabinet



323
AV Cabinet
Pro Audio Rack
Corner Cabinet



329 - Speaker Integration
AV Cabinet
Corner Cabinet



236 - Speaker Integration
AV Cabinet (Wall Mountable)



237
AV Cabinet (Wall Mountable)



337
AV Cabinet
Low Profile Cabinet



336 - Speaker Integration
AV Cabinet



339 - Speaker Integration
AV Cabinet



247
AV Cabinet (Wall Mountable)



347
AV Cabinet
Low Profile Cabinet



245 - Speaker Integration
AV Cabinet (Wall Mountable)



345 - Speaker Integration
AV Cabinet
Low Profile Cabinet

built on
C
FRAME



CORSICA

AMERICAN CHERRY, BLACK GLASS

This easy going and laid back style is represented in a cherry finish, with extra-thick end panels.





CORSICA

AMERICAN CHERRY, BLACK GLASS



American Cherry Finish,
Solid Wood Framed Smoked Glass
Door With Hidden Finger Pull



Black Speaker Grill
(Models 329, 236, 336 & 339)



Black Tempered Glass Top

See Models & Dimensions on pages 26-31



217
Audio Cabinet
Subwoofer Enclosure



317
Audio Cabinet
Pro Audio Rack



517
Audio Cabinet
Pro Audio Rack



617
Audio Cabinet
Pro Audio Rack



221
AV Cabinet
Corner Cabinet



323
AV Cabinet
Pro Audio Rack
Corner Cabinet



329 - Speaker Integration
AV Cabinet
Corner Cabinet



236 - Speaker Integration
AV Cabinet



237
AV Cabinet



337
AV Cabinet



336 - Speaker Integration
AV Cabinet



339 - Speaker Integration
AV Cabinet



247
AV Cabinet



347
AV Cabinet



245 - Speaker Integration
AV Cabinet



345 - Speaker Integration
AV Cabinet

built on
C
FRAME

Triple-Width 236 On-Wall
(Wall Kit Sold Separately)



DENVER

MEDIUM WALNUT, BARK TEXTURE, GLASS TOP

Deeply embossed, horizontal grains- akin to wheat stalks, offer a rustic look.



***MULTIPLE TOP
OPTIONS AVAILABLE
CALL FOR DETAILS**

*Black Glass top
comes standard*

Custom fee will apply



Solid Surface - Black

*Glass - Black



DENVER

MEDIUM WALNUT,
BARK TEXTURE

See Models & Dimensions on pages 26-31



217
Audio Cabinet
Subwoofer Enclosure



221
AV Cabinet (Wall Mountable)
Corner Cabinet



237
AV Cabinet (Wall Mountable)



247
AV Cabinet (Wall Mountable)



236 - Projector and Speaker Integration
Epson and Vivitek models



317
Audio Cabinet
Pro Audio Rack



323
AV Cabinet
Pro Audio Rack
Corner Cabinet



337
AV Cabinet
Low Profile Cabinet



347
AV Cabinet
Low Profile Cabinet



237 - Projector Integration
Vivitek and Epson models



517
Audio Cabinet
Pro Audio Rack



329 - Speaker Integration
AV Cabinet
Corner Cabinet



336 - Speaker Integration
AV Cabinet



245 - Speaker Integration
AV Cabinet (Wall Mountable)



245 - Projector and Speaker Integration
Hisense



617
Audio Cabinet
Pro Audio Rack



236 - Speaker Integration
AV Cabinet (Wall Mountable)



339 - Speaker Integration
AV Cabinet



345 - Speaker Integration
AV Cabinet
Low Profile Cabinet

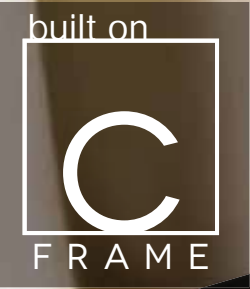

DENVER

NATURAL WALNUT, GLASS TOP

Deeply embossed, horizontal grains- akin to bark, offer a rustic look.



***MULTIPLE TOP
OPTIONS AVAILABLE
CALL FOR DETAILS**

*Black Glass top
comes standard*

Custom fee will apply





DENVER

NATURAL OAK, BARK TEXTURE

See Models & Dimensions on pages 26-31



236 - Projector and Speaker Integration
Epson and Vivitek models



237 - Projector Integration
Vivitek and Epson models



245 - Projector and Speaker Integration
Hisense



217
Audio Cabinet
Subwoofer Enclosure



317
Audio Cabinet
Pro Audio Rack



517
Audio Cabinet
Pro Audio Rack



617
Audio Cabinet
Pro Audio Rack



221
AV Cabinet (Wall Mountable)
Corner Cabinet



323
AV Cabinet
Pro Audio Rack
Corner Cabinet



329 - Speaker Integration
AV Cabinet
Corner Cabinet



236 - Speaker Integration
AV Cabinet (Wall Mountable)



237
AV Cabinet (Wall Mountable)



337
AV Cabinet
Low Profile Cabinet



336 - Speaker Integration
AV Cabinet



339 - Speaker Integration
AV Cabinet



247
AV Cabinet (Wall Mountable)



347
AV Cabinet
Low Profile Cabinet



245 - Speaker Integration
AV Cabinet (Wall Mountable)



345 - Speaker Integration
AV Cabinet
Low Profile Cabinet

built on



Quad-Width 247 On-Wall
(Wall Kit Sold Separately)

ELBA

AMERICAN CHERRY

Its essence is casual made unique by wide framed wood doors with smoked glass inserts.



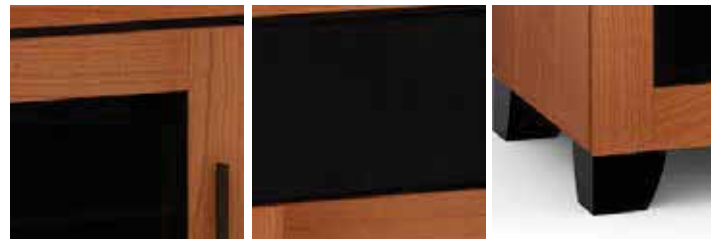

Solid Wood Framed
Smoke Glass Doors

Brown Speaker Grill
(Models 329, 236, 336 & 339)

Black Tapered Solid Wood Feet
with Hidden Adjustable Leveler



217
Audio Cabinet
Subwoofer Enclosure



317
Audio Cabinet
Pro Audio Rack



517
Audio Cabinet
Pro Audio Rack



617
Audio Cabinet
Pro Audio Rack



221
AV Cabinet (Wall Mountable)
Corner Cabinet



323
AV Cabinet
Pro Audio Rack
Corner Cabinet



329 - Speaker Integration
AV Cabinet
Corner Cabinet



236 - Speaker Integration
AV Cabinet (Wall Mountable)



237
AV Cabinet (Wall Mountable)



337
AV Cabinet



336 - Speaker Integration
AV Cabinet



339 - Speaker Integration
AV Cabinet



247
AV Cabinet (Wall Mountable)



347
AV Cabinet



245 - Speaker Integration
AV Cabinet (Wall Mountable)



345 - Speaker Integration
AV Cabinet



HAMPTON

DISTRESSED BLACK

This finely crafted unit in distressed black finish is a charming and comfortable design that brings to mind a traditional English country home.





Distressed Black Finish, Raised Panel With Wood Knob



Black Speaker Grill
(Models 236)



Black, Tapered Solid Wood Feet With Hidden Levelers



221
AV Cabinet
Corner Cabinet



237
AV Cabinet



236 - Speaker Integration
AV Cabinet

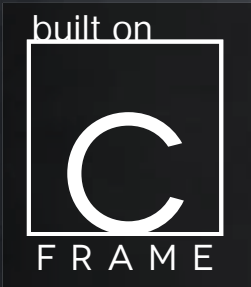

LANCASTER

ROUGH-SAWN BARN BOARD TEXTURE

A rustic, country atmosphere, Lancaster resembles rough-sawn barn board with a comfortable, yet stylish aged appearance.

 **LANCASTER**
ROUGH-SAWN BARN BOARD TEXTURE

See Models & Dimensions on pages 26-31



Deep textured, barn board doors, top and end panels



Espresso, low-profile wood feet with hidden levelers



217
Audio Cabinet
Subwoofer Enclosure



317
Audio Cabinet
Pro Audio Rack



517
Audio Cabinet
Pro Audio Rack



617
Audio Cabinet
Pro Audio Rack



221
AV Cabinet (Wall Mountable)
Corner Cabinet



323
AV Cabinet
Pro Audio Rack
Corner Cabinet



329 - Speaker Integration
AV Cabinet
Corner Cabinet



236 - Speaker Integration
AV Cabinet (Wall Mountable)



237
AV Cabinet (Wall Mountable)



337
AV Cabinet
Low Profile Cabinet



336 - Speaker Integration
AV Cabinet



339 - Speaker Integration
AV Cabinet



247
AV Cabinet (Wall Mountable)



347
AV Cabinet
Low Profile Cabinet



245 - Speaker Integration
AV Cabinet (Wall Mountable)



345 - Speaker Integration
AV Cabinet
Low Profile Cabinet



MIAMI

WARM GLOSS WHITE

High-gloss, warm white side panels and doors beautifully offset the black glass top.



***MULTIPLE TOP
OPTIONS AVAILABLE
CALL FOR DETAILS**

*Black Glass top
comes standard*

Custom fee will apply



Solid Surface - Black

Solid Surface - White

Glass - Black



236 - Projector and Speaker Integration
Epson and Vivitek models



237 - Projector Integration
Vivitek and Epson models



245 - Projector and Speaker Integration
Sony and Hisense models



217
Audio Cabinet
Subwoofer Enclosure



317
Audio Cabinet
Pro Audio Rack



517
Audio Cabinet
Pro Audio Rack



617
Audio Cabinet
Pro Audio Rack



221
AV Cabinet (Wall Mountable)
Corner Cabinet



323
AV Cabinet
Pro Audio Rack
Corner Cabinet



329 - Speaker Integration
AV Cabinet
Corner Cabinet



236 - Speaker Integration
AV Cabinet (Wall Mountable)



237
AV Cabinet (Wall Mountable)



337
AV Cabinet
Low Profile Cabinet



336 - Speaker Integration
AV Cabinet



339 - Speaker Integration
AV Cabinet



247
AV Cabinet (Wall Mountable)



347
AV Cabinet
Low Profile Cabinet



245 - Speaker Integration
AV Cabinet (Wall Mountable)



345 - Speaker Integration
AV Cabinet
Low Profile Cabinet



Quad-Width 247
On-Wall
(Wall Kit Sold Separately)



MILAN

3-DIMENSIONAL DIAMOND DOOR PATTERN, GLASS TOP

Finished in white, Milan is a sleek door design with a modern geometric three-dimensional, diamond pattern with black glass top.



***MULTIPLE TOP
OPTIONS AVAILABLE
CALL FOR DETAILS**

*Black Glass top
comes standard*

Custom fee will apply



Solid Surface - Black
Solid Surface - White
Glass - Black



236 - Projector and Speaker Integration
Epson and Vivitek models



237 - Projector Integration
Vivitek and Epson models



245 - Projector and Speaker Integration
Hisense



217
Audio Cabinet
Subwoofer Enclosure



317
Audio Cabinet
Pro Audio Rack



517
Audio Cabinet
Pro Audio Rack



617
Audio Cabinet
Pro Audio Rack



221
AV Cabinet (Wall Mountable)
Corner Cabinet



323
AV Cabinet
Pro Audio Rack
Corner Cabinet



329 - Speaker Integration
AV Cabinet
Corner Cabinet



236 - Speaker Integration
AV Cabinet (Wall Mountable)



237
AV Cabinet (Wall Mountable)



337
AV Cabinet
Low Profile Cabinet



336 - Speaker Integration
AV Cabinet



339 - Speaker Integration
AV Cabinet



247
AV Cabinet (Wall Mountable)



347
AV Cabinet
Low Profile Cabinet



245 - Speaker Integration
AV Cabinet (Wall Mountable)



345 - Speaker Integration
AV Cabinet
Low Profile Cabinet



OSLO

BLACK GLASS, BLACK OAK

Black beauty's ultra-sleek techno aesthetic with smoked glass doors and black glass top.



***MULTIPLE TOP
OPTIONS AVAILABLE
CALL FOR DETAILS**

*Black Glass top
comes standard*

Custom fee will apply



Solid Surface - Black

*Glass - Black



236 - Projector and Speaker Integration
Epson and Vivitek models



237 - Projector Integration
Vivitek and Epson models



245 - Projector and Speaker Integration
Sony and Hisense models



217
Audio Cabinet
Subwoofer Enclosure



317
Audio Cabinet
Pro Audio Rack



517
Audio Cabinet
Pro Audio Rack



617
Audio Cabinet
Pro Audio Rack



221
AV Cabinet (Wall Mountable)
Corner Cabinet



323
AV Cabinet
Pro Audio Rack
Corner Cabinet



329 - Speaker Integration
AV Cabinet
Corner Cabinet



236 - Speaker Integration
AV Cabinet (Wall Mountable)



237
AV Cabinet (Wall Mountable)



337
AV Cabinet
Low Profile Cabinet



336 - Speaker Integration
AV Cabinet



339 - Speaker Integration
AV Cabinet



247
AV Cabinet (Wall Mountable)



347
AV Cabinet
Low Profile Cabinet



245 - Speaker Integration
AV Cabinet (Wall Mountable)



345 - Speaker Integration
AV Cabinet
Low Profile Cabinet



Triple-Width 237

SEATTLE

ALPI GRAY OAK, GRASS TEXTURE, GLAS TOP

The light look and feel of tall grasses is finely set in a vertical textured pattern. Alpi gray oak with black glass top and black feet work in unison, creating the cabinet's hi-tech facade.



***MULTIPLE TOP
OPTIONS AVAILABLE
CALL FOR DETAILS**

*Black Glass top
comes standard*

Custom fee will apply

Solid Surface - Black

*Glass - Black





SEATTLE

ALPI GRAY OAK, GRASS
TEXTURE, BLACK GLASS

See Models & Dimensions on pages 26-31



236 - Projector and Speaker Integration
Epson and Vivitek models



237 - Projector Integration
Vivitek and Epson models



245 - Projector and Speaker Integration
Hisense and Sony models



217
Audio Cabinet
Subwoofer Enclosure



317
Audio Cabinet
Pro Audio Rack



517
Audio Cabinet
Pro Audio Rack



617
Audio Cabinet
Pro Audio Rack



221
AV Cabinet (Wall Mountable)
Corner Cabinet



323
AV Cabinet
Pro Audio Rack
Corner Cabinet



329 - Speaker Integration
AV Cabinet
Corner Cabinet



236 - Speaker Integration
AV Cabinet (Wall Mountable)



237
AV Cabinet (Wall Mountable)



337
AV Cabinet
Low Profile Cabinet



336 - Speaker Integration
AV Cabinet



339 - Speaker Integration
AV Cabinet



247
AV Cabinet (Wall Mountable)



347
AV Cabinet
Low Profile Cabinet



245 - Speaker Integration
AV Cabinet (Wall Mountable)



345 - Speaker Integration
AV Cabinet
Low Profile Cabinet

built on



Triple-Width 339 and
Single-Width 217



SONOMA

AMERICAN CHERRY

This elegantly crafted design is rendered in American cherry and includes vertical slatted doors with black micro-perforated steel inserts for an updated Mission Style.



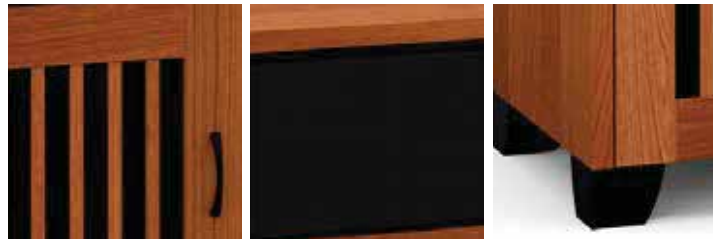

American Cherry Finish, Solid Wood Framed Panel With Mullions And Micro-Perforated Steel Inserts With Black Pulls

Brown Speaker Grill
(Models 329, 236, 336 & 339)

Black, Tapered Solid Wood Feet With Hidden Levelers



217
Audio Cabinet
Subwoofer Enclosure



317
Audio Cabinet
Pro Audio Rack



517
Audio Cabinet
Pro Audio Rack



617
Audio Cabinet
Pro Audio Rack



221
AV Cabinet (Wall Mountable)
Corner Cabinet



323
AV Cabinet
Pro Audio Rack
Corner Cabinet



329 - Speaker Integration
AV Cabinet
Corner Cabinet



236 - Speaker Integration
AV Cabinet (Wall Mountable)



237
AV Cabinet (Wall Mountable)



337
AV Cabinet



336 - Speaker Integration
AV Cabinet



339 - Speaker Integration
AV Cabinet



247
AV Cabinet (Wall Mountable)



347
AV Cabinet



245 - Speaker Integration
AV Cabinet (Wall Mountable)



345 - Speaker Integration
AV Cabinet



VENICE

ANTIQUÉ CHERRY

The romance of a Tuscan villa is the inspiration for this cabinet with antique cherry glazed finish and brass hardware for a classic antique look.



Antique Cherry Finish, Miter Frame And Panel Doors With Aged Brass Knobs



Brown Speaker Grill
Model 329



Cherry, Tapered Solid Wood Feet With Hidden Levelers



221
AV Cabinet
Corner Cabinet



323
AV Cabinet
Pro Audio Rack
Corner Cabinet



329 - Speaker Integration
AV Cabinet
Corner Cabinet

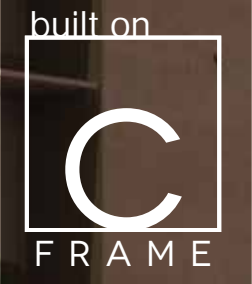

ZURICH

LINEAR TEXTURE, OPIUM BROWN

This sleek, streamlined design features a horizontal pattern on opium brown wood with a black glass or solid surface top and wood block feet



***MULTIPLE TOP
OPTIONS AVAILABLE
CALL FOR DETAILS**

*Black Glass top
comes standard*

Custom fee will apply



Solid Surface - Black

*Glass - Black



ZURICH

OPIUM BROWN, LINEAR TEXTURE

See Models & Dimensions on pages 26-31



236 - Projector and Speaker Integration
Epson and Vivitek models



237 - Projector Integration
Vivitek and Epson models



245 - Projector and Speaker Integration
Hisense



217
Audio Cabinet
Subwoofer Enclosure



317
Audio Cabinet
Pro Audio Rack



517
Audio Cabinet
Pro Audio Rack



617
Audio Cabinet
Pro Audio Rack



221
AV Cabinet (Wall Mountable)
Corner Cabinet



323
AV Cabinet
Pro Audio Rack
Corner Cabinet



329 - Speaker Integration
AV Cabinet
Corner Cabinet



236 - Speaker Integration
AV Cabinet (Wall Mountable)



237
AV Cabinet (Wall Mountable)



337
AV Cabinet
Low Profile Cabinet



336 - Speaker Integration
AV Cabinet



339 - Speaker Integration
AV Cabinet



247
AV Cabinet (Wall Mountable)



347
AV Cabinet
Low Profile Cabinet



245 - Speaker Integration
AV Cabinet (Wall Mountable)



345 - Speaker Integration
AV Cabinet
Low Profile Cabinet



SYNERGY[®]

SYSTEM

Synergy is all about configurability. It is a fully modular furniture system that takes customization to a whole new level. Combine various sized core and extension modules with enclosure elements to create a unique, personal piece of furniture. Or choose from a selection of pre-configured solutions that fits your needs.

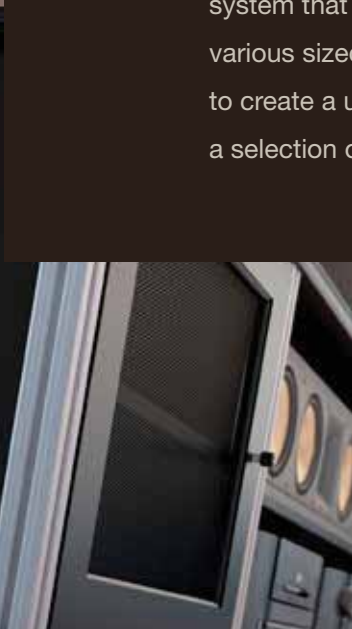



SYNERGY SYSTEM MODULAR



Anodized Supports
are the core of the extremely durable modular system.

Extension Modules
Straight forward additions that make it easy to extend Synergy cabinets.



Removable Rear Panels
allow easy access to components.



Core Modules
For use individually or with modules.

Side Panels
Panels slide neatly between support posts enclosing exterior and interior of units.



Infinitely Adjustable Shelves

Doors
Enclose any cabinet, fully or partially. Doors can be attached both from the left or right. (Doors sold separately.)



Optional, perforated door permit IR signals, add ventilation and mask speakers.



Snap-on hinges fully extend optional doors and remove easily for better in-cabinet access.



Drawers
Enclose any cabinet, fully or partially.

VERSATILE

Our award-winning Synergy System™ is a real breakthrough. It is a fully modular furniture system that takes customization to a whole new level. There are so many possibilities, anyone can create a piece of furniture that is uniquely their own.



Synergy Triple-Width 237, Cherry/Black

SYNERGY SYSTEM

DESIGN YOUR OWN

Personalize the appearance of the Synergy System by combining the finest material options. Choose wood finishes, posts, door inserts and side panels. The selection is all up to you.

- 1. Select a Core Module** - Available in Single-Width (23.75"), Twin-Width (44"), Triple-Width (66.25") or Quad-Width (88") in 12", 21", 31" or 41" heights.
- 2. Add Extension Modules** - Available in Single-Width (23.75"), Twin-Width (44"), Triple-Width (66.25") in 9.625", 19", 29", or 39" heights.
- 3. Enclose with Side Panels** - Available in black, wood finishes, black perforated steel.
- 4. Outfit with Doors** - Solid wood framed with black perforated steel inserts.
- 5. Select Wood & Posts** - Solid real wood veneers such as dark cherry, natural maple, dark walnut or black on MDF.

Our unique "Design Your Own" process uses an online Custom "Configurator" tool to help people build their own unique pieces of AV furniture. The Configurator lets anyone select the configuration and functional features that match exactly with their desired use. www.salamanderdesigns.com

Assembly Available



Natural Maple

Dark Cherry

Dark Walnut

Black

Perforated Steel Door Insert

Silver Post

Black Post



SYNERGY SYSTEM CUSTOM INTERIORS



STORING

Our personal electronics storage is a great all-in-one organizational space storing remotes and other media devices.

MULTI-FUNCTION

Solidly built, these multi-functional pull-out shelves are specifically designed to support turntables and other heavy equipment.

CHARGING

Conveniently charge and store your mobile devices in our pull-out trays. Now there really is a place for everything.

PRO AUDIO

Cabinets can be outfitted with Rack Mounting Rails that allows integration of professional equipment, conforming to EIA 19" rack standards.





SYNERGY SYSTEM ACCESSORIES

An extensive family of accessories allows customization of cabinets to meet specific needs and preferences. Integrated accessories enhance functionality and provide years of reliable service. Feel confident that you can retrofit and upgrade your furniture whenever your needs change.



Integrated TV and Speaker Mounts
combine directly with cabinets



Accent Light sets the mood and adds light just where you need it



Decorator Feet and Wheels fine tune the style and function



Power Conditioning delivers better picture and sound



IR Repeater allows remote controls to operate through solid doors



Active Cooling system protects delicate electronics



Synergy Triple-Width 237, Cherry/Black



Wall Mounting Kits

The wall hanging cabinet is the ultimate way to create the look of custom cabinetry. See Page 103.





SYNERGY SYSTEM SINGLE MODULES

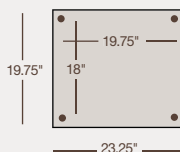

- Open Cabinets can be enclosed with Synergy Doors, Sides and Drawers.
- Infinitely Adjustable, Black Interior Shelves
- Removable Rear Panels provide easy component access.
- Heavy Duty, non-marking leveler feet are standard.
- Capacities:
Top (1.125" thick) holds 150 lbs.
Interior Shelves (3/4" thick) hold 75 lbs each
(Heavy Duty Shelf Brackets hold up to 150 lbs)



Hold TV's
up to 40"



Hold up to
500 lbs

RM Rack Mount Model
Available, See Page 98

W Wall Mountable,
see kit on Page 103

Speaker Integration



Single 20 - Core Module

| | |
|-----------------|---------|
| Black/Black | SU20B/B |
| Black/Aluminum | SU20B/A |
| Cherry/Black | SU20C/B |
| Cherry/Aluminum | SU20C/A |
| Maple/Black | SU20M/B |
| Maple/Aluminum | SU20M/A |
| Walnut/Black | SU20W/B |
| Walnut/Aluminum | SU20W/A |

- 1 Adjustable Shelf

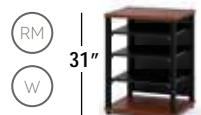

Single 30 - Core Module

| | |
|-----------------|---------|
| Black/Black | SU30B/B |
| Black/Aluminum | SU30B/A |
| Cherry/Black | SU30C/B |
| Cherry/Aluminum | SU30C/A |
| Maple/Black | SU30M/B |
| Maple/Aluminum | SU30M/A |
| Walnut/Black | SU30W/B |
| Walnut/Aluminum | SU30W/A |

- 3 Adjustable Shelves with 1 Set of Heavy Duty Shelf Brackets (hold up to 150 lbs)

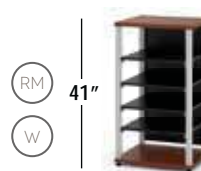

Single 40 - Core Module

| | |
|-----------------|---------|
| Black/Black | SU40B/B |
| Black/Aluminum | SU40B/A |
| Cherry/Black | SU40C/B |
| Cherry/Aluminum | SU40C/A |
| Maple/Black | SU40M/B |
| Maple/Aluminum | SU40M/A |
| Walnut/Black | SU40W/B |
| Walnut/Aluminum | SU40W/A |

- 4 Adjustable Shelves with 1 Set of Heavy Duty Shelf Brackets (hold up to 150 lbs)



Single 20 - Extension Module

| | |
|-----------------|---------|
| Black/Black | SX20B/B |
| Black/Aluminum | SX20B/A |
| Cherry/Black | SX20C/B |
| Cherry/Aluminum | SX20C/A |
| Maple/Black | SX20M/B |
| Maple/Aluminum | SX20M/A |
| Walnut/Black | SX20W/B |
| Walnut/Aluminum | SX20W/A |

- 1 Adjustable Shelf



Single 30 - Extension Module

| | |
|-----------------|---------|
| Black/Black | SX30B/B |
| Black/Aluminum | SX30B/A |
| Cherry/Black | SX30C/B |
| Cherry/Aluminum | SX30C/A |
| Maple/Black | SX30M/B |
| Maple/Aluminum | SX30M/A |
| Walnut/Black | SX30W/B |
| Walnut/Aluminum | SX30W/A |

- 2 Adjustable Shelves with 1 Set of Heavy Duty Shelf Brackets (hold up to 150 lbs)



Single 40 - Extension Module

| | |
|-----------------|---------|
| Black/Black | SX40B/B |
| Black/Aluminum | SX40B/A |
| Cherry/Black | SX40C/B |
| Cherry/Aluminum | SX40C/A |
| Maple/Black | SX40M/B |
| Maple/Aluminum | SX40M/A |
| Walnut/Black | SX40W/B |
| Walnut/Aluminum | SX40W/A |

- 4 Adjustable Shelves with 1 Set of Heavy Duty Shelf Brackets (hold up to 150 lbs)

SIDES

- Choose matching side panels or mix wood sides with black, perforated steel sides to help keep equipment cool.
- Segregate bays with interior side panels (Quads order 2 sets, Triples order 1 set).
- Sold in sets of 2.



Synergy 10 Sides

| | |
|------------------------|--------|
| Black | SS10/B |
| Cherry | SS10/C |
| Maple | SS10/M |
| Walnut | SS10/W |
| Black Perforated Steel | SS10/P |
| Tan Suede Leather | SS10/L |

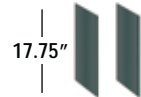

Synergy 20 Sides

| | |
|------------------------|--------|
| Black | SS20/B |
| Cherry | SS20/C |
| Maple | SS20/M |
| Walnut | SS20/W |
| Black Perforated Steel | SS20/P |
| Tan Suede Leather | SS20/L |



Synergy 30 Sides

| | |
|------------------------|--------|
| Black | SS30/B |
| Cherry | SS30/C |
| Maple | SS30/M |
| Walnut | SS30/W |
| Black Perforated Steel | SS30/P |
| Tan Suede Leather | SS30/L |



Synergy 40 Sides

| | |
|------------------------|--------|
| Black | SS40/B |
| Cherry | SS40/C |
| Maple | SS40/M |
| Walnut | SS40/W |
| Black Perforated Steel | SS40/P |
| Tan Suede Leather | SS40/L |

DOORS

- Can be attached to open from left or right.
- Permit Infra-red signals.
- Perforated steel panels keep equipment cool and conceal speakers.
- Door lock compatible with all doors.
- Solid hardwood frames with insert panels.
- Machined aluminum with black rubber door pull.



Synergy 10 Doors

| | |
|-------------------------|---------|
| Black/Perforated Steel | SD10B/P |
| Cherry/Perforated Steel | SD10C/P |
| Maple/Perforated Steel | SD10M/P |
| Walnut/Perforated Steel | SD10W/P |

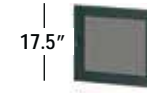

Synergy 20 Doors

| | |
|-------------------------|---------|
| Black/Perforated Steel | SD20B/P |
| Cherry/Perforated Steel | SD20C/P |
| Maple/Perforated Steel | SD20M/P |
| Walnut/Perforated Steel | SD20W/P |



Synergy 30 Doors

| | |
|-------------------------|---------|
| Black/Perforated Steel | SD30B/P |
| Cherry/Perforated Steel | SD30C/P |
| Maple/Perforated Steel | SD30M/P |
| Walnut/Perforated Steel | SD30W/P |



Synergy 40 Doors

| | |
|-------------------------|---------|
| Black/Perforated Steel | SD40B/P |
| Cherry/Perforated Steel | SD40C/P |
| Maple/Perforated Steel | SD40M/P |
| Walnut/Perforated Steel | SD40W/P |

DRAWERS

- Metal sided with solid hardwood face.



Synergy Drawers

| | |
|--------|---------|
| Black | SA/MD/B |
| Cherry | SA/MD/C |
| Maple | SA/MD/M |
| Walnut | SA/MD/W |

• CANNOT BE PLACED BEHIND DOORS.

- Interior Dimensions: 18.375"W x 6"H x 15.75"D
- Exterior Dimensions: 19.5"W x 6.75"H x 17.5"D
- Load Capacity: 100 lbs.
- Capacity: 102 CD's or 52 DVD



Synergy Door Locks

| | |
|---------------------------------|------------|
| DYI Door Lock Kit | SD/LOCK |
| Factory Installed Door Lock Kit | FI/SD/LOCK |

- The Synergy Door Lock Kit allows you to add a lock to any Synergy Door.
- DYI kit requires drilling, bit included.



SYNERGY SYSTEM TWIN CORE MODULES

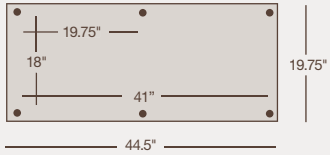

- Open Cabinets can be enclosed with Synergy Doors, Sides and Drawers.
- Infinitely Adjustable, Black Interior Shelves
- Removable Rear Panels provide easy component access.
- Heavy Duty, non-marking leveler feet are standard.
- Capacities:
 - Top (1.125" thick) holds 250 lbs.
 - Interior Shelves (3/4" thick) hold 75 lbs each (Heavy Duty Shelf Brackets hold up to 150 lbs)



Hold TV's
up to 50"



Hold up to
750 lbs



Twin 10 - Core Module

| | |
|-----------------|---------|
| Black/Black | SN10B/B |
| Black/Aluminum | SN10B/A |
| Cherry/Black | SN10C/B |
| Cherry/Aluminum | SN10C/A |
| Maple/Black | SN10M/B |
| Maple/Aluminum | SN10M/A |
| Walnut/Black | SN10W/B |
| Walnut/Aluminum | SN10W/A |

- DOES NOT include adjustable shelves.



Twin 20 - Core Module

| | |
|-----------------|---------|
| Black/Black | SN20B/B |
| Black/Aluminum | SN20B/A |
| Cherry/Black | SN20C/B |
| Cherry/Aluminum | SN20C/A |
| Maple/Black | SN20M/B |
| Maple/Aluminum | SN20M/A |
| Walnut/Black | SN20W/B |
| Walnut/Aluminum | SN20W/A |

- Includes 2 adjustable shelves.



Twin 30 - Core Module

| | |
|-----------------|---------|
| Black/Black | SN30B/B |
| Black/Aluminum | SN30B/A |
| Cherry/Black | SN30C/B |
| Cherry/Aluminum | SN30C/A |
| Maple/Black | SN30M/B |
| Maple/Aluminum | SN30M/A |
| Walnut/Black | SN30W/B |
| Walnut/Aluminum | SN30W/A |

- Includes 4 adjustable shelves with 2 Sets of Heavy Duty Shelf Brackets (hold up to 150 lbs)

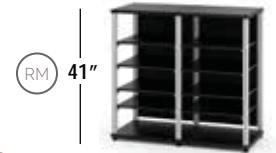

Twin 40 - Core Module

| | |
|-----------------|---------|
| Black/Black | SN40B/B |
| Black/Aluminum | SN40B/A |
| Cherry/Black | SN40C/B |
| Cherry/Aluminum | SN40C/A |
| Maple/Black | SN40M/B |
| Maple/Aluminum | SN40M/A |
| Walnut/Black | SN40W/B |
| Walnut/Aluminum | SN40W/A |

- Includes 8 adjustable shelves with 2 sets of heavy duty shelf brackets (hold up to 150 lbs)



Twin 20 Open Center - Core Module

| | |
|-----------------|----------|
| Black/Black | SNC20B/B |
| Black/Aluminum | SNC20B/A |
| Cherry/Black | SNC20C/B |
| Cherry/Aluminum | SNC20C/A |
| Maple/Black | SNC20M/B |
| Maple/Aluminum | SNC20M/A |
| Walnut/Black | SNC20W/B |
| Walnut/Aluminum | SNC20W/A |

- Top Holds a Maximum of 200 lbs.
- Twin-Width Center Opening: 41"W x 8.5"H x 17.5"D
- Bottom 2 Bays: 19.75"W x 8.5"H x 18"D
- Bottom Bays accommodate Synergy 10 Doors (see page 75)



Twin 30 Open Center - Core Module

| | |
|-----------------|----------|
| Black/Black | SNC30B/B |
| Black/Aluminum | SNC30B/A |
| Cherry/Black | SNC30C/B |
| Cherry/Aluminum | SNC30C/A |
| Maple/Black | SNC30M/B |
| Maple/Aluminum | SNC30M/A |
| Walnut/Black | SNC30W/B |
| Walnut/Aluminum | SNC30W/A |

- Top Holds a Maximum of 200 lbs.
- Twin-Width Center Opening: 41"W x 8.5"H x 17.5"D
- Bottom 2 Bays: 19.75"W x 17.75"H x 18"D, 2 Adjustable Shelves
- Bottom Bays accommodate Synergy 20 Doors (see page 75)

RM Rack Mount Model Available, See Page 98

W Wall Mountable, see kit on Page 103

Speaker Integration





Twin 20 - Extension Module

| | |
|-----------------|----------|
| Black/Black | SNX20B/B |
| Black/Aluminum | SNX20B/A |
| Cherry/Black | SNX20C/B |
| Cherry/Aluminum | SNX20C/A |
| Maple/Black | SNX20M/B |
| Maple/Aluminum | SNX20M/A |
| Walnut/Black | SNX20W/B |
| Walnut/Aluminum | SNX20W/A |

- Includes 2 adjustable shelves.



Twin 30 - Extension Module

| | |
|-----------------|----------|
| Black/Black | SNX30B/B |
| Black/Aluminum | SNX30B/A |
| Cherry/Black | SNX30C/B |
| Cherry/Aluminum | SNX30C/A |
| Maple/Black | SNX30M/B |
| Maple/Aluminum | SNX30M/A |
| Walnut/Black | SNX30W/B |
| Walnut/Aluminum | SNX30W/A |

- Includes 4 adjustable shelves with 2 Sets of Heavy Duty Shelf Brackets (hold up to 150 lbs)

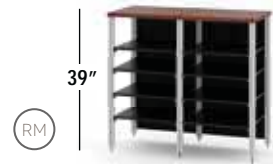

Twin 40 - Extension Module

| | |
|-----------------|----------|
| Black/Black | SNX40B/B |
| Black/Aluminum | SNX40B/A |
| Cherry/Black | SNX40C/B |
| Cherry/Aluminum | SNX40C/A |
| Maple/Black | SNX40M/B |
| Maple/Aluminum | SNX40M/A |
| Walnut/Black | SNX40W/B |
| Walnut/Aluminum | SNX40W/A |

- Includes 8 adjustable shelves and 2 sets of heavy duty shelf brackets (hold up to 150 lbs.).



Twin 10 - Riser Module

| | |
|--------------------------------|--------|
| Black with 8.5" Black Post | SNRB/B |
| Black with 8.5" Aluminum Post | SNRB/A |
| Cherry with 8.5" Black Post | SNRC/B |
| Cherry with 8.5" Aluminum Post | SNRC/A |
| Maple with 8.5" Black Post | SNRM/B |
| Maple with 8.5" Aluminum Post | SNRM/A |
| Walnut with 8.5" Black Post | SNRW/B |
| Walnut with 8.5" Aluminum Post | SNRW/A |

- * Top Holds a Maximum of 200 lbs.
- Interior: 41"W x 8.5"H x 17.5"D



Twin Custom Cut - Riser Module

| | |
|-----------------|---------|
| Black/Black | SNRXB/B |
| Black/Aluminum | SNRXB/A |
| Cherry/Black | SNRXC/B |
| Cherry/Aluminum | SNRXC/A |
| Maple/Black | SNRXM/B |
| Maple/Aluminum | SNRXM/A |
| Walnut/Black | SNRXW/B |
| Walnut/Aluminum | SNRXW/A |

- * Top Holds a Maximum of 200 lbs.
- Includes custom cut rear panels.
- MUST specify a post height when ordering, 3 - 17.75" in increments of 1/4".
- Please allow for 1/16" tolerance.



Custom Cut Side Panels for Riser

| | |
|-------------------|---------|
| Black | SSX20/B |
| Cherry | SSX20/C |
| Maple | SSX20/M |
| Walnut | SSX20/W |
| Tan Suede Leather | SSX20/L |

- MUST specify a post height when ordering, 3 - 17.75" in increments of 1/4".
- Please allow for 1/16" tolerance.

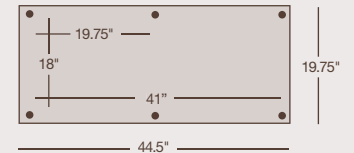

- Open Cabinets can be enclosed with Synergy Doors, Sides and Drawers.
- Infinitely Adjustable, Black Interior Shelves
- Attach to Any Synergy Twin Core Module
- Removable Rear Panels provide easy component access.
- Removable Rear Panels provide easy component access.
- Capacities:
Top (1.125" thick) holds 350 lbs.
Interior Shelves (3/4" thick) hold 75 lbs each



Hold TV's
up to 50"



Hold up to
750 lbs



Rack Mount Model
Available, See Page 98



Speaker Integration





SYNERGY SYSTEM TRIPLE CORE MODULES

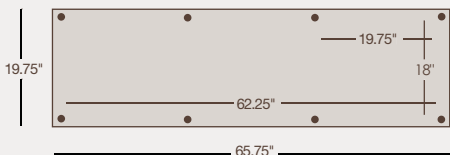

- Open Cabinets can be enclosed with Synergy Doors, Sides and Drawers.
- Removable Rear Panels provide easy component access.
- Heavy Duty, non-marking leveler feet are standard.
- Segregate Bays with 2 Interior Side Panels
- Capacities:
Top (1.125" thick) holds 350 lbs.
Interior Shelves (3/4" thick) hold 75 lbs each
(Heavy Duty Shelf Brackets hold up to 150 lbs)



Hold TV's
up to 75"



Hold up to
1000 lbs

 Rack Mount Model
Available, See Page 98

 Wall Mountable,
see kit on Page 103

 Speaker Integration



Triple 10 - Core Module

| | |
|-----------------|---------|
| Black/Black | SL10B/B |
| Black/Aluminum | SL10B/A |
| Cherry/Black | SL10C/B |
| Cherry/Aluminum | SL10C/A |
| Maple/Black | SL10M/B |
| Maple/Aluminum | SL10M/A |
| Walnut/Black | SL10W/B |
| Walnut/Aluminum | SL10W/A |

- DOES NOT include adjustable shelves.



Triple 20 - Core Module

| | |
|-----------------|---------|
| Black/Black | SL20B/B |
| Black/Aluminum | SL20B/A |
| Cherry/Black | SL20C/B |
| Cherry/Aluminum | SL20C/A |
| Maple/Black | SL20M/B |
| Maple/Aluminum | SL20M/A |
| Walnut/Black | SL20W/B |
| Walnut/Aluminum | SL20W/A |

- Includes 3 adjustable shelves.



Triple 30 - Core Module

| | |
|-----------------|---------|
| Black/Black | SL30B/B |
| Black/Aluminum | SL30B/A |
| Cherry/Black | SL30C/B |
| Cherry/Aluminum | SL30C/A |
| Maple/Black | SL30M/B |
| Maple/Aluminum | SL30M/A |
| Walnut/Black | SL30W/B |
| Walnut/Aluminum | SL30W/A |

- Includes 6 adjustable shelves with 3 Set of Heavy Duty Shelf Brackets
(hold up to 150 lbs).



Triple 40 - Core Module

| | |
|-----------------|---------|
| Black/Black | SL40B/B |
| Black/Aluminum | SL40B/A |
| Cherry/Black | SL40C/B |
| Cherry/Aluminum | SL40C/A |
| Maple/Black | SL40M/B |
| Maple/Aluminum | SL40M/A |
| Walnut/Black | SL40W/B |
| Walnut/Aluminum | SL40W/A |

- Includes 9 adjustable shelves with 3 sets of heavy duty shelf brackets (hold up to 150 lbs)



Triple 20 Open Center - Core Module

| | |
|-----------------|----------|
| Black/Black | SLC20B/B |
| Black/Aluminum | SLC20B/A |
| Cherry/Black | SLC20C/B |
| Cherry/Aluminum | SLC20C/A |
| Maple/Black | SLC20M/B |
| Maple/Aluminum | SLC20M/A |
| Walnut/Black | SLC20W/B |
| Walnut/Aluminum | SLC20W/A |

- *Top Holds a Maximum of 150 lbs.
- Triple-Width Center Opening: 62.25"W x 7.5"H x 17.5"
- Bottom 3 Bays: 19.75"W x 8.5"H x 18"D
- Bottom Bays accommodate Synergy 10 Doors (see page 75)



Triple 30 Open Center - Core Module

| | |
|-----------------|----------|
| Black/Black | SLC30B/B |
| Black/Aluminum | SLC30B/A |
| Cherry/Black | SLC30C/B |
| Cherry/Aluminum | SLC30C/A |
| Maple/Black | SLC30M/B |
| Maple/Aluminum | SLC30M/A |
| Walnut/Black | SLC30W/B |
| Walnut/Aluminum | SLC30W/A |

- Top Holds a Maximum of 150 lbs.
- Triple-Width Center Opening: 62.25"W x 8.25"H x 17.5"
- Bottom 3 Bays: 19.75"W x 17.75"H x 18"D, 3 Adjustable Shelves
- Bottom Bays accommodate Synergy 20 Doors (see page 75)



TRIPLE RISERS & EXTENSIONS



Triple 20 - Extension Module

| | |
|-----------------|----------|
| Black/Black | SLX20B/B |
| Black/Aluminum | SLX20B/A |
| Cherry/Black | SLX20C/B |
| Cherry/Aluminum | SLX20C/A |
| Maple/Black | SLX20M/B |
| Maple/Aluminum | SLX20M/A |
| Walnut/Black | SLX20W/B |
| Walnut/Aluminum | SLX20W/A |

- Includes 3 adjustable shelves.



Triple 30 - Extension Module

| | |
|-----------------|----------|
| Black/Black | SLX30B/B |
| Black/Aluminum | SLX30B/A |
| Cherry/Black | SLX30C/B |
| Cherry/Aluminum | SLX30C/A |
| Maple/Black | SLX30M/B |
| Maple/Aluminum | SLX30M/A |
| Walnut/Black | SLX30W/B |
| Walnut/Aluminum | SLX30W/A |

- Includes 6 adjustable shelves with 3 sets of heavy duty shelf brackets (hold up to 150 lbs)



Triple 10 - Riser Module

| | |
|-----------------|--------|
| Black/Black | SLRB/A |
| Black/Aluminum | SLRB/A |
| Cherry/Black | SLRC/B |
| Cherry/Aluminum | SLRC/A |
| Maple/Black | SLRM/B |
| Maple/Aluminum | SLRM/A |
| Walnut/Black | SLRW/B |
| Walnut/Aluminum | SLRW/A |

- * Top Holds a Maximum of 125 lbs.
- Interior: 62.25"W x 8.5"H x 17.5"D



Triple Custom Cut - Riser Module

| | |
|-----------------|---------|
| Black/Black | SLRXB/B |
| Black/Aluminum | SLRXB/A |
| Cherry/Black | SLRXC/B |
| Cherry/Aluminum | SLRXC/A |
| Maple/Black | SLRXM/B |
| Maple/Aluminum | SLRXM/A |
| Walnut/Black | SLRXW/B |
| Walnut/Aluminum | SLRXW/A |

- * Top Holds a Maximum of 125 lbs.
- Includes custom cut rear panels.
- MUST specify a post height when ordering, 3 - 17.75" in increments of 1/4".
- Please allow for 1/16" tolerance.



Custom Cut Side Panels for Riser

| | |
|-------------------|---------|
| Black | SSX20/B |
| Cherry | SSX20/C |
| Maple | SSX20/M |
| Walnut | SSX20/W |
| Tan Suede Leather | SSX20/L |

- MUST specify a post height when ordering, 3 - 17.75" in increments of 1/4".
- Please allow for 1/16" tolerance.

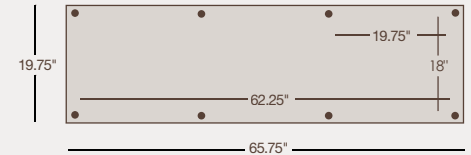

- Open Cabinets can be enclosed with Synergy Doors, Sides and Drawers.
- Infinitely Adjustable, Black Interior Shelves
- Attach to Any Synergy Triple Core Module
- Segregate Bays with 1 Interior Side Panel
- Removable Rear Panels provide easy component access.
- Capacities:
 - Top (1.125" thick) holds 350 lbs.
 - Interior Shelves (3/4" thick) hold 75 lbs each (Heavy Duty Shelf Brackets hold up to 150 lbs)



Hold TV's up to 75"



Hold up to 1000 lbs



Rack Mount Model Available, See Page 98



Speaker Integration

built on





SYNERGY SYSTEM QUAD MODULES

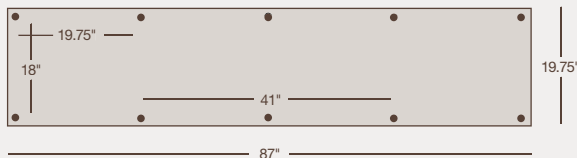

- Open Cabinets can be enclosed with Synergy Doors, Sides and Drawers.
- Removable Rear Panels provide easy component access.
- Heavy Duty, non-marking leveler feet are standard.
- Segregate Bays with 1 Interior Side Panel
- Capacities:
 - Top (1.125" thick) holds 350 lbs.
 - Interior Shelves (3/4" thick) hold 75 lbs each (Heavy Duty Shelf Brackets hold up to 150 lbs)



Hold TV's
up to 90"



Hold up to
1000 lbs



Quad 10 - Core Module

| | |
|-----------------|---------|
| Black/Black | SQ10B/B |
| Black/Aluminum | SQ10B/A |
| Cherry/Black | SQ10C/B |
| Cherry/Aluminum | SQ10C/A |
| Maple/Black | SQ10M/B |
| Maple/Aluminum | SQ10M/A |
| Walnut/Black | SQ10W/B |
| Walnut/Aluminum | SQ10W/A |

- DOES NOT include adjustable shelves.



Quad 20 - Core Module

| | |
|-----------------|---------|
| Black/Black | SQ20B/B |
| Black/Aluminum | SQ20B/A |
| Cherry/Black | SQ20C/B |
| Cherry/Aluminum | SQ20C/A |
| Maple/Black | SQ20M/B |
| Maple/Aluminum | SQ20M/A |
| Walnut/Black | SQ20W/B |
| Walnut/Aluminum | SQ20W/A |

- Includes 4 adjustable shelves.



Quad 20 Open Center - Core Module

| | |
|-----------------|----------|
| Black/Black | SQC20B/B |
| Black/Aluminum | SQC20B/A |
| Cherry/Black | SQC20C/B |
| Cherry/Aluminum | SQC20C/A |
| Maple/Black | SQC20M/B |
| Maple/Aluminum | SQC20M/A |
| Walnut/Black | SQC20W/B |
| Walnut/Aluminum | SQC20W/A |

- Includes 2 adjustable shelves.



Quad 30 - Core Module

| | |
|-----------------|---------|
| Black/Black | SQ30B/B |
| Black/Aluminum | SQ30B/A |
| Cherry/Black | SQ30C/B |
| Cherry/Aluminum | SQ30C/A |
| Maple/Black | SQ30M/B |
| Maple/Aluminum | SQ30M/A |
| Walnut/Black | SQ30W/B |
| Walnut/Aluminum | SQ30W/A |

- Includes 8 adjustable shelves with 4 sets of heavy duty shelf brackets (hold up to 150 lbs)



Quad 30 Open Center- Core Module

| | |
|-----------------|----------|
| Black/Black | SQC30B/B |
| Black/Aluminum | SQC30B/A |
| Cherry/Black | SQC30C/B |
| Cherry/Aluminum | SQC30C/A |
| Maple/Black | SQC30M/B |
| Maple/Aluminum | SQC30M/A |
| Walnut/Black | SQC30W/B |
| Walnut/Aluminum | SQC30W/A |

- Includes 8 adjustable shelves.

W Wall Mountable,
see kit on Page 103

Speaker Integration



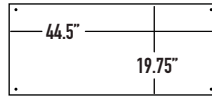

Synergy Bridge Three

| | |
|--------|-------|
| Black | SB3/B |
| Cherry | SB3/C |
| Maple | SB3/M |
| Walnut | SB3/W |

- Holds TV's Up To 46".
- Total Maximum Weight Capacity: 100 lbs.
- 46" Maximum Width with Brackets Fully Extended
- 1.125" Thick

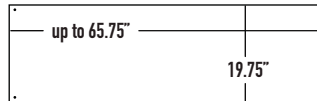

Synergy Custom Cut Bridge

| | |
|--------|-------|
| Black | SBX/B |
| Cherry | SBX/C |
| Maple | SBX/M |
| Walnut | SBX/W |

- Must provide actual TV width and we add 1" for clearance (67.75" Max.)
- Total Maximum Weight Capacity: 100 lbs.
- 1.125" Thick

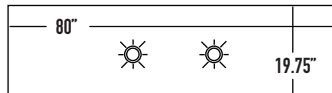

Synergy Plank Bridge with Lights

| | |
|--------|-------|
| Black | SBP/B |
| Cherry | SBP/C |
| Maple | SBP/M |
| Walnut | SBP/W |

- Rests on top of two Synergy towers and spans TV's up to 72".
- Includes recessed puck lights.
- Total Maximum Weight Capacity: 150 lbs.
- 2.5" Thick
- *While supplies last.*



Synergy Amplifier Stand

| | |
|--------|--------|
| Black | SAMP/B |
| Cherry | SAMP/C |
| Maple | SAMP/M |
| Walnut | SAMP/W |

- Total Maximum Weight Capacity: 250 lbs.
- Includes 3" Polished Aluminum Claw Feet
- 23.25" x 19.75" x 4.5"



SYNERGY™

PRE-CONFIGURED SOLUTIONS

AVAILABLE IN: WALNUT, BLACK, CHERRY & MAPLE
WITH BLACK PERFORATED STEEL DOORS



Synergy Single 303

| | |
|-----------------|----------|
| Black/Black | SB303B/B |
| Black/Aluminum | SB303B/A |
| Cherry/Black | SB303C/B |
| Cherry/Aluminum | SB303C/A |
| Maple/Black | SB303M/B |
| Maple/Aluminum | SB303M/A |
| Walnut/Black | SB303W/B |
| Walnut/Aluminum | SB303W/A |

23.25" w x 31" h x 19.75" d
• 3 Adjustable Shelves



Synergy Single 402

| | |
|-----------------|----------|
| Black/Black | SB402B/B |
| Black/Aluminum | SB402B/A |
| Cherry/Black | SB402C/B |
| Cherry/Aluminum | SB402C/A |
| Maple/Black | SB402M/B |
| Maple/Aluminum | SB402M/A |
| Walnut/Black | SB402W/B |
| Walnut/Aluminum | SB402W/A |

23.25" w x 41" h x 19.75" d
• 4 Adjustable Shelves



Synergy Single 603

| | |
|-----------------|--------|
| Black/Black | 603B/B |
| Black/Aluminum | 603B/A |
| Cherry/Black | 603C/B |
| Cherry/Aluminum | 603C/A |
| Maple/Black | 603M/B |
| Maple/Aluminum | 603M/A |
| Walnut/Black | 603W/B |
| Walnut/Aluminum | 603W/A |

23.25" w x 60" h x 19.75" d
• 4 Adjustable Shelves



Synergy Single 703

| | |
|-----------------|--------|
| Black/Black | 703B/B |
| Black/Aluminum | 703B/A |
| Cherry/Black | 703C/B |
| Cherry/Aluminum | 703C/A |
| Maple/Black | 703M/B |
| Maple/Aluminum | 703M/A |
| Walnut/Black | 703W/B |
| Walnut/Aluminum | 703W/A |

23.25" w x 70" h x 19.75" d
• 7 Adjustable Shelves



Synergy Twin 221

| | |
|-----------------|----------|
| Black/Black | SB221B/B |
| Black/Aluminum | SB221B/A |
| Cherry/Black | SB221C/B |
| Cherry/Aluminum | SB221C/A |
| Maple/Black | SB221M/B |
| Maple/Aluminum | SB221M/A |
| Walnut/Black | SB221W/B |
| Walnut/Aluminum | SB221W/A |

44.5" w x 21" h x 19.75" d
• 2 Adjustable Shelves



Synergy Twin 229

| | |
|-----------------|----------|
| Black/Black | SB229B/B |
| Black/Aluminum | SB229B/A |
| Cherry/Black | SB229C/B |
| Cherry/Aluminum | SB229C/A |
| Maple/Black | SB229M/B |
| Maple/Aluminum | SB229M/A |
| Walnut/Black | SB229W/B |
| Walnut/Aluminum | SB229W/A |

44.5" w x 21" h x 19.75" d
Center Opening 41" w x 18" d x 8.5" h



Synergy Twin 323

| | |
|-----------------|----------|
| Black/Black | SB323B/B |
| Black/Aluminum | SB323B/A |
| Cherry/Black | SB323C/B |
| Cherry/Aluminum | SB323C/A |
| Maple/Black | SB323M/B |
| Maple/Aluminum | SB323M/A |
| Walnut/Black | SB323W/B |
| Walnut/Aluminum | SB323W/A |

44.5" w x 31" h x 19.75" d
• 4 Adjustable Shelves



Synergy Twin 329

| | |
|-----------------|----------|
| Black/Black | SB329B/B |
| Black/Aluminum | SB329B/A |
| Cherry/Black | SB329C/B |
| Cherry/Aluminum | SB329C/A |
| Maple/Black | SB329M/B |
| Maple/Aluminum | SB329M/A |
| Walnut/Black | SB329W/B |
| Walnut/Aluminum | SB329W/A |

44.5" w x 31" h x 19.75" d
• 2 Adjustable Shelves



Synergy Triple 132

| | |
|-----------------|----------|
| Black/Black | SB132B/B |
| Black/Aluminum | SB132B/A |
| Cherry/Black | SB132C/B |
| Cherry/Aluminum | SB132C/A |
| Maple/Black | SB132M/B |
| Maple/Aluminum | SB132M/A |
| Walnut/Black | SB132W/B |
| Walnut/Aluminum | SB132W/A |

65.75" w x 12" h x 19.75" d
Center Opening 19.75" w x 18" d x 8.5" h



Synergy Triple 133

| | |
|-----------------|----------|
| Black/Black | SB133B/B |
| Black/Aluminum | SB133B/A |
| Cherry/Black | SB133C/B |
| Cherry/Aluminum | SB133C/A |
| Maple/Black | SB133M/B |
| Maple/Aluminum | SB133M/A |
| Walnut/Black | SB133W/B |
| Walnut/Aluminum | SB133W/A |

65.75" w x 12" h x 19.75" d



Synergy Triple 237

| | |
|-----------------|----------|
| Black/Black | SB237B/B |
| Black/Aluminum | SB237B/A |
| Cherry/Black | SB237C/B |
| Cherry/Aluminum | SB237C/A |
| Maple/Black | SB237M/B |
| Maple/Aluminum | SB237M/A |
| Walnut/Black | SB237W/B |
| Walnut/Aluminum | SB237W/A |

65.75" w x 21" h x 19.75" d
• 3 Adjustable Shelves

W Wall Mountable,
see kit on Page 103

S Speaker Integration



PRE-CONFIGURED SOLUTIONS

See Interior Specs on Page 84



Synergy Triple 236

| | |
|-----------------|----------|
| Black/Black | SB236B/B |
| Black/Aluminum | SB236B/A |
| Cherry/Black | SB236C/B |
| Cherry/Aluminum | SB236C/A |
| Maple/Black | SB236M/B |
| Maple/Aluminum | SB236M/A |
| Walnut/Black | SB236W/B |
| Walnut/Aluminum | SB236W/A |

65.75" w x 21" h x 19.75" d

- 2 Adjustable Shelves
- Center Speaker / Multi-Functional Compartment
- 1 Drawer



Synergy Triple 339

| | |
|-----------------|----------|
| Black/Black | SB339B/B |
| Black/Aluminum | SB339B/A |
| Cherry/Black | SB339C/B |
| Cherry/Aluminum | SB339C/A |
| Maple/Black | SB339M/B |
| Maple/Aluminum | SB339M/A |
| Walnut/Black | SB339W/B |
| Walnut/Aluminum | SB339W/A |

65.75" w x 31" h x 19.75" d

- 3 Adjustable Shelves
- Center Speaker / Multi-Functional Compartment



Synergy Triple 337

| | |
|-----------------|----------|
| Black/Black | SB337B/B |
| Black/Aluminum | SB337B/A |
| Cherry/Black | SB337C/B |
| Cherry/Aluminum | SB337C/A |
| Maple/Black | SB337M/B |
| Maple/Aluminum | SB337M/A |
| Walnut/Black | SB337W/B |
| Walnut/Aluminum | SB337W/A |

65.75" w x 31" h x 19.75" d

- 6 Adjustable Shelves



Synergy Quad 147

| | |
|-----------------|--------|
| Black/Black | 147B/B |
| Black/Aluminum | 147B/A |
| Cherry/Black | 147C/B |
| Cherry/Aluminum | 147C/A |
| Maple/Black | 147M/B |
| Maple/Aluminum | 147M/A |
| Walnut/Black | 147W/B |
| Walnut/Aluminum | 147W/A |

87" w x 12" h x 19.75" d



Synergy Quad 245

| | |
|-----------------|--------|
| Black/Black | 245B/B |
| Black/Aluminum | 245B/A |
| Cherry/Black | 245C/B |
| Cherry/Aluminum | 245C/A |
| Maple/Black | 245M/B |
| Maple/Aluminum | 245M/A |
| Walnut/Black | 245W/B |
| Walnut/Aluminum | 245W/A |

87" w x 21" h x 19.75" d

- 2 Adjustable Shelves
- Center Speaker / Multi-Functional Compartment



Synergy Quad 247

| | |
|-----------------|--------|
| Black/Black | 247B/B |
| Black/Aluminum | 247B/A |
| Cherry/Black | 247C/B |
| Cherry/Aluminum | 247C/A |
| Maple/Black | 247M/B |
| Maple/Aluminum | 247M/A |
| Walnut/Black | 247W/B |
| Walnut/Aluminum | 247W/A |

87" w x 21" h x 19.75" d

- 4 Adjustable Shelves



Synergy Quad 248

| | |
|-----------------|--------|
| Black/Black | 248B/B |
| Black/Aluminum | 248B/A |
| Cherry/Black | 248C/B |
| Cherry/Aluminum | 248C/A |
| Maple/Black | 248M/B |
| Maple/Aluminum | 248M/A |
| Walnut/Black | 248W/B |
| Walnut/Aluminum | 248W/A |

87" w x 21" h x 19.75" d

- 2 Adjustable Shelves
- Center Speaker / Multi-Functional Compartment



Synergy Quad 345

| | |
|-----------------|--------|
| Black/Black | 345B/B |
| Black/Aluminum | 345B/A |
| Cherry/Black | 345C/B |
| Cherry/Aluminum | 345C/A |
| Maple/Black | 345M/B |
| Maple/Aluminum | 345M/A |
| Walnut/Black | 345W/B |
| Walnut/Aluminum | 345W/A |

87" w x 31" h x 19.75" d

- 6 Adjustable Shelves
- Center Speaker / Multi-Functional Compartment



Synergy Quad 347

| | |
|-----------------|--------|
| Black/Black | 347B/B |
| Black/Aluminum | 347B/A |
| Cherry/Black | 347C/B |
| Cherry/Aluminum | 347C/A |
| Maple/Black | 347M/B |
| Maple/Aluminum | 347M/A |
| Walnut/Black | 347W/B |
| Walnut/Aluminum | 347W/A |

87" w x 31" h x 19.75" d

- 8 Adjustable Shelves

 Wall Mountable, see kit on Page 103

 Speaker Integration



SYNERGY[®]

SPECIFICATIONS



303

Rec. TV Size: up to 40"
Top Holds: 350 lbs

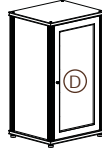

402

Rec. TV Size: up to 40"
Top Holds: 350 lbs

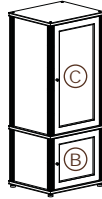

603

Top Holds: 350 lbs

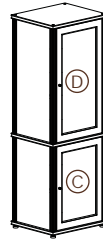

703

Top Holds: 350 lbs

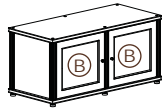

221

Rec. TV Size: up to 50"
Top Holds: 350 lbs



229

Rec. TV Size: up to 50"
Top Holds: 350 lbs

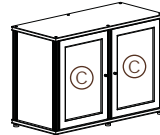

323

Rec. TV Size: up to 50"
Top Holds: 350 lbs

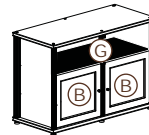

329

Rec. TV Size: up to 50"
Top Holds: 200 lbs

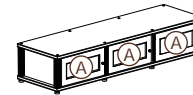

132 & 133

Rec. TV Size: up to 75"
Top Holds: 350 lbs

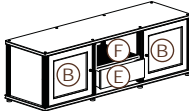

236

Rec. TV Size: up to 75"
Top Holds: 350 lbs

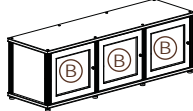

237

Rec. TV Size: up to 75"
Top Holds: 350 lbs

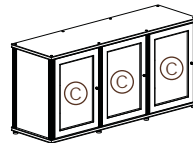

337

Rec. TV Size: up to 75"
Top Holds: 350 lbs

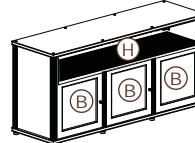

339

Rec. TV Size: up to 75"
Top Holds: 150 lbs

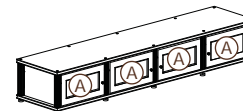

147

Rec. TV Size: up to 90"
Top Holds: 350 lbs

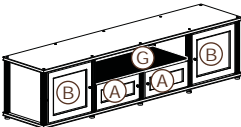

245

Rec. TV Size: up to 90"
Top Holds: 350 lbs

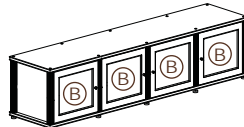

247

Rec. TV Size: up to 90"
Top Holds: 350 lbs

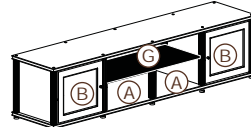

248

Rec. TV Size: up to 90"
Top Holds: 350 lbs

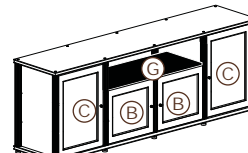

345

Rec. TV Size: up to 90"
Top Holds: 350 lbs

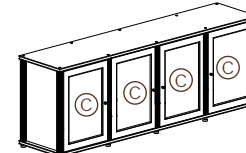

347

Rec. TV Size: up to 90"
Top Holds: 350 lbs

Single-Width Compartments

- A** 19.75"W x 18"D x 8.5"H
- B** 19.75"W x 18"D x 17.75"H
- C** 19.75"W x 18"D x 27.75"H
- D** 19.75"W x 18"D x 37.75"H

E Media Drawer

8.625"W x 18"D x 7.75"H
Holds 75 DVD's or 111 CD's

F Single-Width Center Speaker, Multi-Functional Compartment

19.75"W x 18"D x 8.5"H

G Double-Width Center Speaker, Multi-Functional Compartment

41"W x 18"D x 8.5"H

H Triple-Width Center Speaker, Multi-Functional Compartment

62.25"W x 17.5"D x 7.5"H

SYNERGY[®]

PRO AUDIO SYSTEM

A fully modular pro audio system that takes customization to a whole new level. A virtually limitless number of configurations and an extensive range of accessories allow you to create highly personalized Pro Audio racks and cabinets with premium components that will deliver exceptional reliability and durability. Mounts are compatible with industry standard, EIA 19" components.



SYNERGY™

PRO AUDIO MODULAR RACKS



The anodized aluminum supports are the core of the extremely durable modular system.

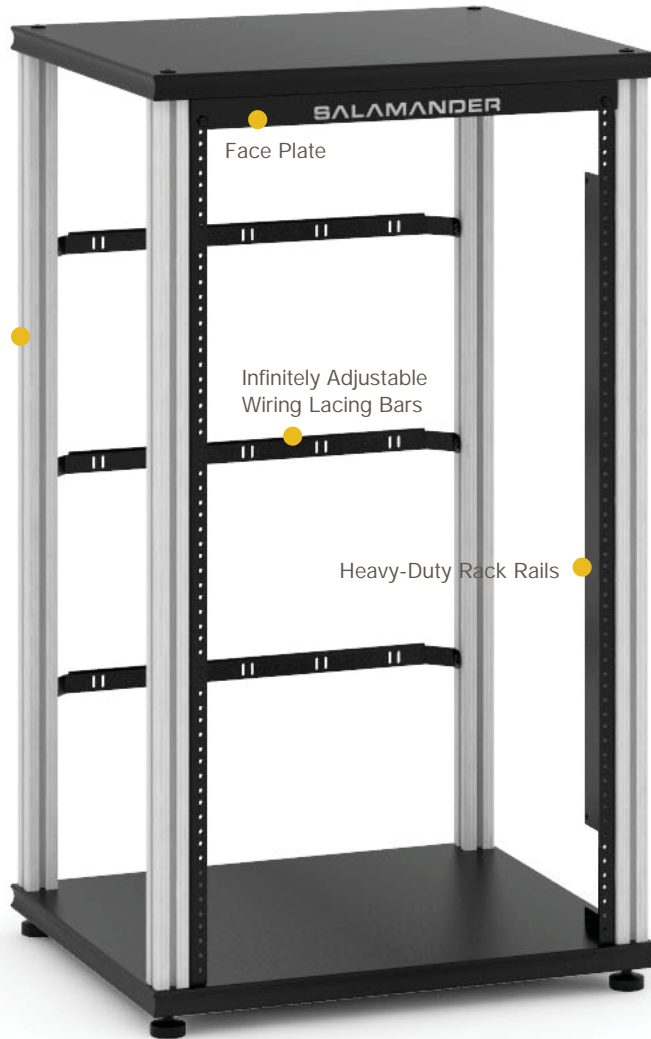
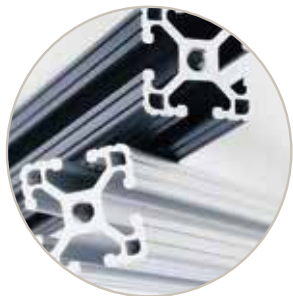

| Model | Rack Units | Top Capacity | Maximum Capacity |
|-----------|------------|--------------|------------------|
| SINGLE 20 | 10 | 150 lbs. | 500 lbs. |
| SINGLE 30 | 15 | 150 lbs. | 500 lbs. |
| SINGLE 40 | 21 | 150 lbs. | 500 lbs. |
| TWIN 20 | 20 | 250 lbs. | 750 lbs. |
| TWIN 30 | 30 | 250 lbs. | 750 lbs. |
| TWIN 40 | 42 | 250 lbs. | 750 lbs. |
| TRIPLE 20 | 30 | 350 lbs. | 1000 lbs. |
| TRIPLE 30 | 45 | 350 lbs. | 1000 lbs. |
| TRIPLE 40 | 63 | 350 lbs. | 1000 lbs. |

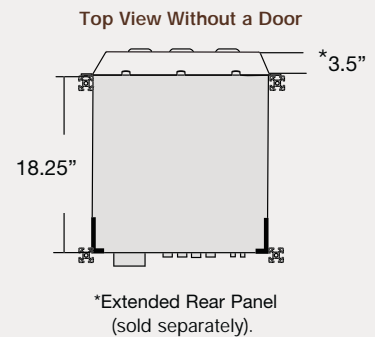
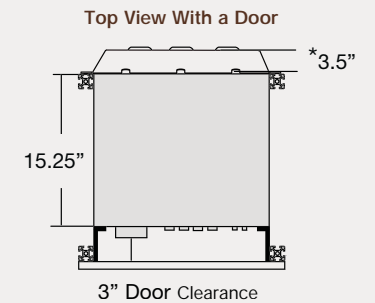



Single 20 Rack Mount - Core Module

| | |
|-----------------|-----------|
| Black/Black | SU20RMB/B |
| Black/Aluminum | SU20RMB/A |
| Cherry/Black | SU20RMC/B |
| Cherry/Aluminum | SU20RMC/A |
| Maple/Black | SU20RMM/B |
| Maple/Aluminum | SU20RMM/A |
| Walnut/Black | SU20RMW/B |
| Walnut/Aluminum | SU20RMW/A |

- Holds up to 10 U's.
- Includes 1 Lacing Bar



Single 30 Rack Mount - Core Module

| | |
|-----------------|-----------|
| Black/Black | SU30RMB/B |
| Black/Aluminum | SU30RMB/A |
| Cherry/Black | SU30RMC/B |
| Cherry/Aluminum | SU30RMC/A |
| Maple/Black | SU30RMM/B |
| Maple/Aluminum | SU30RMM/A |
| Walnut/Black | SU30RMW/B |
| Walnut/Aluminum | SU30RMW/A |

- Holds up to 15 U's.
- Includes 2 Lacing Bars



Single 40 Rack Mount - Core Module

| | |
|-----------------|-----------|
| Black/Black | SU40RMB/B |
| Black/Aluminum | SU40RMB/A |
| Cherry/Black | SU40RMC/B |
| Cherry/Aluminum | SU40RMC/A |
| Maple/Black | SU40RMM/B |
| Maple/Aluminum | SU40RMM/A |
| Walnut/Black | SU40RMW/B |
| Walnut/Aluminum | SU40RMW/A |

- Holds up to 21 U's.
- Includes 3 Lacing Bars



Single 20 Rack Mount - Extension Module

| | |
|-----------------|-----------|
| Black/Black | SX20RMB/B |
| Black/Aluminum | SX20RMB/A |
| Cherry/Black | SX20RMC/B |
| Cherry/Aluminum | SX20RMC/A |
| Maple/Black | SX20RMM/B |
| Maple/Aluminum | SX20RMM/A |
| Walnut/Black | SX20RMW/B |
| Walnut/Aluminum | SX20RMW/A |

- Holds up to 10 U's.
- Includes 1 Lacing Bar



Single 30 Rack Mount - Extension Module

| | |
|-----------------|-----------|
| Black/Black | SX30RMB/B |
| Black/Aluminum | SX30RMB/A |
| Cherry/Black | SX30RMC/B |
| Cherry/Aluminum | SX30RMC/A |
| Maple/Black | SX30RMM/B |
| Maple/Aluminum | SX30RMM/A |
| Walnut/Black | SX30RMW/B |
| Walnut/Aluminum | SX30RMW/A |

- Holds up to 15 U's.
- Includes 2 Lacing Bars



Single 40 Rack Mount - Extension Module

| | |
|-----------------|-----------|
| Black/Black | SX40RMB/B |
| Black/Aluminum | SX40RMB/A |
| Cherry/Black | SX40RMC/B |
| Cherry/Aluminum | SX40RMC/A |
| Maple/Black | SX40RMM/B |
| Maple/Aluminum | SX40RMM/A |
| Walnut/Black | SX40RMW/B |
| Walnut/Aluminum | SX40RMW/A |

- Holds up to 21 U's.
- Includes 3 Lacing Bars

built on

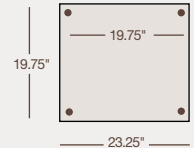

- Heavy duty rack rails.
- Open modules can be enclosed with Doors and Sides
- Rear wire lacing bars included. No rear panel.
- Heavy Duty, non-marking leveler feet are standard.
- Top (1.125" thick) holds 150 lbs.
- Faceplate included.
- Optional Rack Rails may be added to the rear.



Hold TV's
up to 40"



Hold up to
500 lbs

Wire Management

See Page 99 for Accessories.





SYNERGY SYSTEM

TWIN PRO AUDIO MODULES

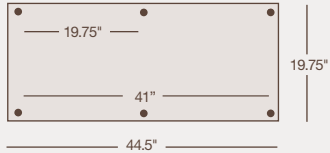

- Heavy duty rack rails.
- Open modules can be enclosed with Doors and Sides
- Rear wire lacing bars included. No rear panels.
- Heavy Duty, non-marking leveler feet are standard.
- Top (1.125" thick) holds 250 lbs.
- Faceplate included.



Hold TV's
up to 50"



Hold up to
750 lbs

Vented Rack Mount Shelves

See Page 99 for Accessories.



Twin 20 Rack Mount - Core Module

| | |
|-----------------|-----------|
| Black/Black | SN20RMB/B |
| Black/Aluminum | SN20RMB/A |
| Cherry/Black | SN20RMC/B |
| Cherry/Aluminum | SN20RMC/A |
| Maple/Black | SN20RMM/B |
| Maple/Aluminum | SN20RMM/A |
| Walnut/Black | SN20RMW/B |
| Walnut/Aluminum | SN20RMW/A |

- Holds up to 20 U's.
- Includes 2 Lacing Bars



Twin 30 Rack Mount - Core Module

| | |
|-----------------|-----------|
| Black/Black | SN30RMB/B |
| Black/Aluminum | SN30RMB/A |
| Cherry/Black | SN30RMC/B |
| Cherry/Aluminum | SN30RMC/A |
| Maple/Black | SN30RMM/B |
| Maple/Aluminum | SN30RMM/A |
| Walnut/Black | SN30RMW/B |
| Walnut/Aluminum | SN30RMW/A |

- Holds up to 30 U's.
- Includes 4 Lacing Bars



Twin 40 Rack Mount - Core Module

| | |
|-----------------|-----------|
| Black/Black | SN40RMB/B |
| Black/Aluminum | SN40RMB/A |
| Cherry/Black | SN40RMC/B |
| Cherry/Aluminum | SN40RMC/A |
| Maple/Black | SN40RMM/B |
| Maple/Aluminum | SN40RMM/A |
| Walnut/Black | SN40RMW/B |
| Walnut/Aluminum | SN40RMW/A |

- Holds up to 42 U's.
- Includes 6 Lacing Bars



Twin 20 Rack Mount - Extension Module

| | |
|-----------------|------------|
| Black/Black | SNX20RMB/B |
| Black/Aluminum | SNX20RMB/A |
| Cherry/Black | SNX20RMC/B |
| Cherry/Aluminum | SNX20RMC/A |
| Maple/Black | SNX20RMM/B |
| Maple/Aluminum | SNX20RMM/A |
| Walnut/Black | SNX20RMW/B |
| Walnut/Aluminum | SNX20RMW/A |

- Holds up to 20 U's.
- Includes 2 Lacing Bars



Twin 30 Rack Mount - Extension Module

| | |
|-----------------|------------|
| Black/Black | SNX30RMB/B |
| Black/Aluminum | SNX30RMB/A |
| Cherry/Black | SNX30RMC/B |
| Cherry/Aluminum | SNX30RMC/A |
| Maple/Black | SNX30RMM/B |
| Maple/Aluminum | SNX30RMM/A |
| Walnut/Black | SNX30RMW/B |
| Walnut/Aluminum | SNX30RMW/A |

- Holds up to 30 U's.
- Includes 4 Lacing Bars



Twin 40 Rack Mount - Extension Module

| | |
|-----------------|------------|
| Black/Black | SNX40RMB/B |
| Black/Aluminum | SNX40RMB/A |
| Cherry/Black | SNX40RMC/B |
| Cherry/Aluminum | SNX40RMC/A |
| Maple/Black | SNX40RMM/B |
| Maple/Aluminum | SNX40RMM/A |
| Walnut/Black | SNX40RMW/B |
| Walnut/Aluminum | SNX40RMW/A |

- Holds up to 42 U's.
- Includes 6 Lacing Bars



TRIPLE PRO AUDIO MODULES



Triple 20 Rack Mount - Core Module

| | |
|-----------------|-----------|
| Black/Black | SL20RMB/B |
| Black/Aluminum | SL20RMB/A |
| Cherry/Black | SL20RMC/B |
| Cherry/Aluminum | SL20RMC/A |
| Maple/Black | SL20RMM/B |
| Maple/Aluminum | SL20RMM/A |
| Walnut/Black | SL20RMW/B |
| Walnut/Aluminum | SL20RMW/A |

- Holds up to 30 U's.
- Includes 3 Lacing Bars



Triple 30 Rack Mount - Core Module

| | |
|-----------------|-----------|
| Black/Black | SL30RMB/B |
| Black/Aluminum | SL30RMB/A |
| Cherry/Black | SL30RMC/B |
| Cherry/Aluminum | SL30RMC/A |
| Maple/Black | SL30RMM/B |
| Maple/Aluminum | SL30RMM/A |
| Walnut/Black | SL30RMW/B |
| Walnut/Aluminum | SL30RMW/A |

- Holds up to 45 U's.
- Includes 6 Lacing Bars



Triple 40 Rack Mount - Core Module

| | |
|-----------------|-----------|
| Black/Black | SL40RMB/B |
| Black/Aluminum | SL40RMB/A |
| Cherry/Black | SL40RMC/B |
| Cherry/Aluminum | SL40RMC/A |
| Maple/Black | SL40RMM/B |
| Maple/Aluminum | SL40RMM/A |
| Walnut/Black | SL40RMW/B |
| Walnut/Aluminum | SL40RMW/A |

- Holds up to 63 U's.
- Includes 9 Lacing Bars



Triple 20 Rack Mount - Extension Module

| | |
|-----------------|------------|
| Black/Black | SLX20RMB/B |
| Black/Aluminum | SLX20RMB/A |
| Cherry/Black | SLX20RMC/B |
| Cherry/Aluminum | SLX20RMC/A |
| Maple/Black | SLX20RMM/B |
| Maple/Aluminum | SLX20RMM/A |
| Walnut/Black | SLX20RMW/B |
| Walnut/Aluminum | SLX20RMW/A |

- Holds up to 30 U's.
- Includes 3 Lacing Bars



Triple 30 Rack Mount - Extension Module

| | |
|-----------------|------------|
| Black/Black | SLX30RMB/B |
| Black/Aluminum | SLX30RMB/A |
| Cherry/Black | SLX30RMC/B |
| Cherry/Aluminum | SLX30RMC/A |
| Maple/Black | SLX30RMM/B |
| Maple/Aluminum | SLX30RMM/A |
| Walnut/Black | SLX30RMW/B |
| Walnut/Aluminum | SLX30RMW/A |

- Holds up to 45 U's.
- Includes 6 Lacing Bars



Triple 40 Rack Mount - Extension Module

| | |
|-----------------|------------|
| Black/Black | SLX40RMB/B |
| Black/Aluminum | SLX40RMB/A |
| Cherry/Black | SLX40RMC/B |
| Cherry/Aluminum | SLX40RMC/A |
| Maple/Black | SLX40RMM/B |
| Maple/Aluminum | SLX40RMM/A |
| Walnut/Black | SLX40RMW/B |
| Walnut/Aluminum | SLX40RMW/A |

- Holds up to 63 U's.
- Includes 9 Lacing Bars

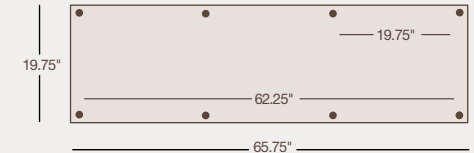

- Heavy duty rack rails.
- Open modules can be enclosed with Doors and Sides
- Rear wire lacing bars included. No rear panels.
- Heavy Duty, non-marking leveler feet are standard.
- Top (1.125" thick) holds 350 lbs.
- Faceplate included.



Hold TV's
up to 75"



Hold up to
1000 lbs



Vented Rack Mount Face Plates

See Page 99 for Accessories.

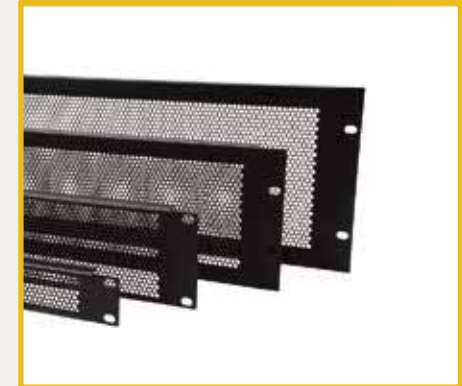



ARCHETYPE™

SYSTEM



ARCHETYPE™

MODULAR SYSTEM

The Archetype System™ is an innovative modular shelving system for audio/video equipment. Infinitely adjustable, it allows anyone to create a wide array of shelving possibilities.

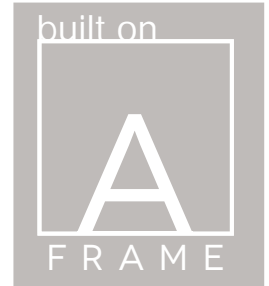

DESIGNING AN ARCHETYPE SYSTEM™

1. Determine Number of Shelves and Height

Audio stands are available in three standard heights (20, 28, 36") and can be extended by stacking units or building with rod and couplers.

2. Select Wood

Solid real woods such as Natural Cherry, Natural Maple, Natural Walnut or Black on MDF.

3. Accessorize

Storage options available.

4. Enhance Footing

Wheels for mobility and spikes to reduce vibration.

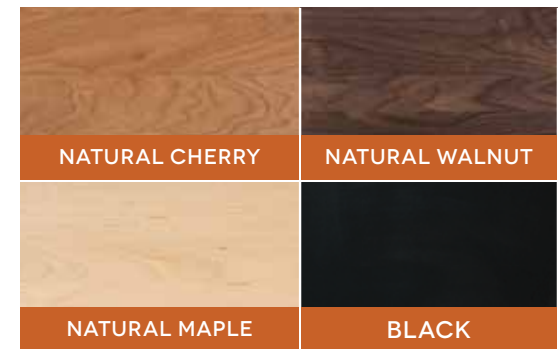

MODULAR

Threaded steel support rods and matching fasteners allow shelves to be fully adjustable while allowing customers to stack units or add individual shelves as needed.

FUNCTIONAL

An Audiophile favorite that has earned "Recommended Component" status from Stereophile magazine, the system includes accessories like Dual-Wheel Casters, Arched Bookends and Drawers that also make it suitable for general shelving.

SURFACE

The 3/4-inch shelves and solid steel posts are rigid and strong enough to support 150 pounds each. Metal and neoprene spacers sandwich shelf corners, further isolating contents from vibration. Select from three attractive, solid hardwood shelf panels (cherry, maple, walnut) or a black MDF panel.



ARCHETYPE SYSTEM

Archetype Shelf Dimensions

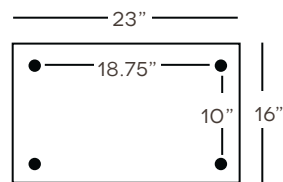

Archetype 2.0

| | |
|--------|------|
| Black | A2/B |
| Cherry | A2/C |
| Maple | A2/M |
| Walnut | A2/W |

- Includes 2 shelves.



Archetype 3.0

| | |
|--------|------|
| Black | A3/B |
| Cherry | A3/C |
| Maple | A3/M |
| Walnut | A3/W |

- Includes 3 shelves.



Archetype 5.0

| | |
|--------|------|
| Black | A5/B |
| Cherry | A5/C |
| Maple | A5/M |
| Walnut | A5/W |

- Includes 5 shelves.



Shelves

| | |
|--------|------|
| Black | SS/B |
| Cherry | SS/C |
| Maple | SS/M |
| Walnut | SS/W |

- Weight Capacity: 150 lbs.
- 23" x 16" x .75"
- Hardware Included

Amplifier Stand

| | |
|--------|-------|
| Black | AMP/B |
| Cherry | AMP/C |
| Maple | AMP/M |
| Walnut | AMP/W |

- Includes Solid Steel, Mega Spikes and floor protectors



Stacking Coupler Kit

| | |
|-----------------|-------|
| Set of 4, Black | STACK |
|-----------------|-------|

- Use to extend or stack any two Archetype units.



Drawer

| | |
|--------|----------|
| Black | DRAWER |
| Silver | DRAWER/S |

- Capacity: 100 CD's, 22 DVD's
- Load Capacity: 100 lbs.
- Interior Dimensions: 18"W x 6.75"H x 15.75"D



Saturn Wheels

| | |
|------------------------|----------|
| Set of 4, Satin Chrome | SATURN/A |
| Set of 4, Satin Black | SATURN/B |

- Weight Capacity: 400 lbs. per set.
- Adds 3.75" to height.
- Set includes locking wheels.



Dual Wheel Casters

| | |
|-----------------|-------|
| Set of 4, Black | WHEEL |
|-----------------|-------|

- CAUTION: Tall, top heavy units should not use wheels for frequent movement.
- Weight Capacity: 200 lbs. per set.
- Adds 3" to height.
- Set includes locking wheels.



Mega Spikes

| | |
|-----------------|-------|
| Set of 4, Black | SPIKE |
|-----------------|-------|

- Performance enhancing heavy duty, machined, solid steel.
- Weight Capacity: 800 lbs.
- Includes floor protector pads.
- Adds 2.25" to height.



Bookends

| | |
|-----------------|------|
| Set of 4, Black | ARCH |
|-----------------|------|

- Easy way to support CD's/DVD's, LP's and books.



Threaded Rods

| | |
|----------------------------|---------|
| Archetype 2.0 - 20", Black | 300-060 |
| Archetype 3.0 - 28", Black | 300-050 |
| Archetype 5.0 - 36", Black | 300-040 |

- Use with stacking kit to extend Archetype units.
- Sold individually.





AV FURNITURE ACCESSORIES

| | |
|--------------------------|-----|
| Integrated TV Mounts | 94 |
| Integrated Speakers | 95 |
| Interior Storage | 96 |
| In-Cabinet Refrigerator | 97 |
| Pro Rack Mounting | 98 |
| Active Cooling | 100 |
| Rear Panels | 100 |
| Integrated Power | 101 |
| Footing | 102 |
| Wall Mounting Kit | 103 |
| Accent Lighting | 104 |
| IR Repeater | 104 |
| Security Lock and Panels | 104 |

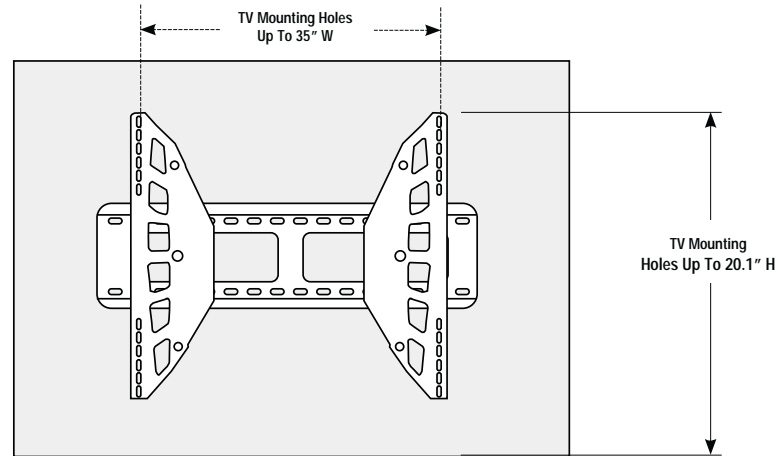

FX 100

FX100 series of integrated cabinet mount is designed to affix TVs to cabinets without the hassle of on-wall wiring and installation.

- Universal TV Mounts
- All TV mounts include cable managers.

| Synergy | Vesa Pattern |
|-----------|--------------------------|
| Twin | min 100x100, 500x300 max |
| Triple | min 200x200, 800x500 max |
| Quad | min 300x300, 900x600 max |
| Chameleon | Vesa Pattern |
| Twin | min 200x200, 800x500 max |
| Triple | min 200x200, 800x500 max |
| Quad | min 300x300, 900x600 max |



Synergy System - FX100 TV Mounts

| | |
|---------------------------|----------|
| For Twin Cabinet, Black | SN/PM2/B |
| For Triple Cabinet, Black | SL/PM2/B |
| For Quad Cabinet, Black | SQ/PM2/B |

* Clearance Below TV - A = 23.5 minus 1/2 of TV Height (This assumes vertical brackets are centered on TV.)



Chameleon Collection - FX100 TV Mounts

| | |
|---------------------------|----------|
| For Twin Cabinet, Black | CN/PM2/B |
| For Triple Cabinet, Black | CL/PM2/B |
| For Quad Cabinet, Black | CQ/PM2/B |

* Clearance Below TV - A = 53.25 minus 1/2 of TV Height minus Cabinet Height (This assumes vertical brackets are centered on TV.)

- Black, panel measures 30"W x 16"H.
- Cannot be used with extended rear panels.

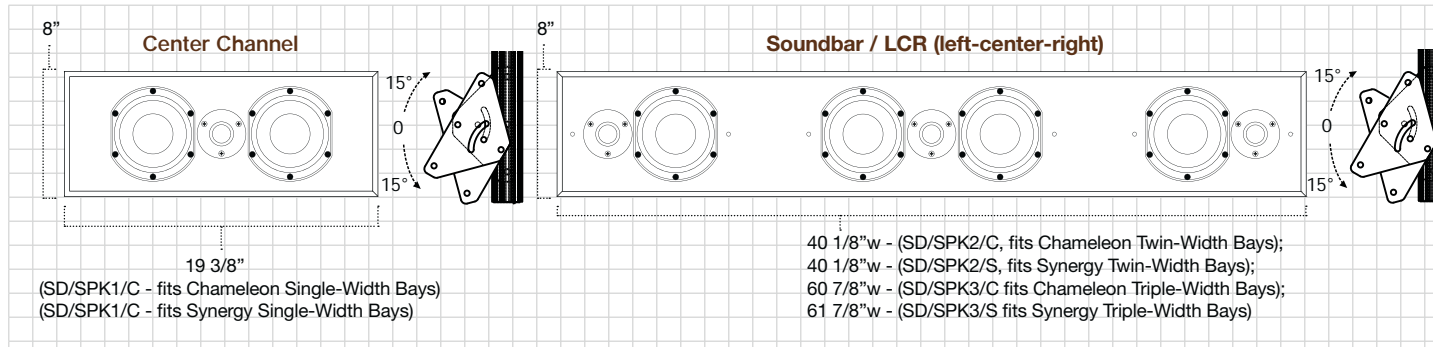

| Components | 5" midrange woofers; 1" audiophile-grade tweeters | | Center Channel | LCR (left-center-right) Speaker |
|------------|--|----------------|-------------------------|---------------------------------|
| Model | SD/SPK1/C, SD/SPK1/S, SD/SPK2/C, SD/SPK2/S, SD/SPK3/C, SD/SPK3/S | Impedance | 8Ω | 6Ω |
| Height | 8" | Rec. Power | 50-250W | 50-250W |
| Width | Varies, depending on model | Maximum Output | 104 dB avg; 110 dB peak | 101 dB avg; 107 dB peak |
| Depth | 4" | Coverage | Hor: 110°; Vert: 140° | Hor: 110°; Vert: 140° |
| Material | Sealed MDF enclosure | Freq. Response | 74-22kHz (+/- 3dB) | 74-22kHz (+/- 3dB) |
| Weight | 15-30 lbs (depending on configuration and width) | Sensitivity | 88dB@2.83V/1m | 88dB@2.83V/1m |

Cabinets accommodate a range of speaker types and sizes. Salamander has partnered with Leon Speakers to offer custom-made premium soundbars to fit most of our cabinets. These center channel and LCR speakers are designed specifically to fit any single, twin or triple-wide speaker opening

- Custom built to seamlessly integrate with our Synergy and Chameleon AV cabinets
- Exclusive mounting brackets allow for articulation to optimize sound dispersion
- High-performance sound platform features world-class woofers and cloth-dome tweeters for exceptional sonic clarity
- Solid MDF construction, meticulously crafted by hand in the USA
- Cabinets accommodate center channel speakers Soundbars and subwoofers. Models: 229, 236, 245, 248, 329, 336, and 339.



In-Cabinet Center Channel

| | |
|---|-----------|
| Single-Width (19 3/8") for Chameleon Collection | SD/SPK1/C |
| Single-Width (19 3/8") for Synergy System | SD/SPK1/S |



In-Cabinet LCR Soundbar

| | |
|---|-----------|
| Twin-Width (40 1/8") for Chameleon Collection | SD/SPK2/C |
| Twin-Width (40 1/8") for Synergy System | SD/SPK2/S |
| Triple-Width (60 7/8") for Chameleon Collection | SD/SPK3/C |
| Triple-Width (61 7/8") for Synergy System | SD/SPK3/S |





Universal Storage Tray

Synergy Storage Tray, Black SA/UST

- Works well with laptops, tablets, personal media storage, gaming systems, cell phone charging station location, etc.
- Utilizes heavy duty ball bearing slides, black steel body with felt liner.
- Can be placed behind doors.
- Maximum Weight Capacity: 50 lbs
- Measures: 17.25" W x 16" D x 1.625" H with 3 locations to install 2 included dividers located at 4" 8.5" and 12.75" from the front edge.
- Compatible with Synergy System & Chameleon Cabinets



Media Trays

Synergy & Chameleon Media Tray 2, Black - Post Mounted SA/UPT2
Chameleon Media Tray 2, Black - Bottom Mounted CA/UPT

- Slotted to hold a selection of DVD's (75) and/or CD's (111) upright.
- Fits neatly behind a door.
- Metal construction, matte black finish.
- Interior Dimensions: 17.125"W x 15.875"D x 3.5"H
- CA/UPT are installed to the bottom shelf of a Chameleon cabinet (one per bay).
- Maximum Weight Capacity: 30 lbs
- Compatible with Synergy System & Chameleon Cabinets



Heavy Duty Pull-Out Shelf

Synergy & Chameleon, Black SA/PS2

- Full extension universal pull-out shelf
- Utilizes heavy duty ball bearing slides, 3/4" black MDF shelf
- Can be placed behind doors.
- Maximum Weight Capacity: 50 lbs
- Measures 18" w x 17.75" deep
- Compatible with Synergy System & Chameleon Cabinets



Synergy Drawer

| | |
|--------|---------|
| Black | SA/MD/B |
| Cherry | SA/MD/C |
| Maple | SA/MD/M |
| Walnut | SA/MD/W |

- **CANNOT BE PLACED BEHIND DOORS.**
- Interior Dimensions: 18.375"W x 6"H x 15.75"D
- Exterior Dimensions: 19.5"W x 6.75"H x 17.5"D
- Load Capacity: 100 lbs., 102 CD's or 52 DVD





Synergy Tempered Glass Shelf

Standard Shelf, Clear Glass SA/G1

- Standard: Weight Capacity: 50 lbs.
- Measures: 19.75"W x 17.5"D x .375" TH.
- Constructed of 3/8" (10mm) clear tempered glass



Synergy Single-Width Shelf

Standard Shelf, Black SA/S1

- Standard: Weight Capacity: 75 lbs.
- Measures: 19.75"W x 17.5"D x .75" TH.
- Includes heavy-duty shelf brackets (150 lbs capacity).

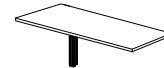

Synergy Double-Width Shelf

| | |
|-------------------------------------|-----------|
| Black Shelf with 8.5" Aluminum Post | SA/DS10/A |
| Black Shelf with 8.5" Black Post | SA/DS10/B |

| | |
|---------------------------------------|-----------|
| Black Shelf with 17.75" Aluminum Post | SA/DS20/A |
| Black Shelf with 17.75" Black Post | SA/DS20/B |

| | |
|---------------------------------------|-----------|
| Black Shelf with 27.75" Aluminum Post | SA/DS30/A |
| Black Shelf with 27.75" Black Post | SA/DS30/B |

- Weight Capacity: 75 lbs.
- Inside Dimensions: 41"W x 17.5"D x 3/4"
- Includes heavy-duty shelf brackets (150 lbs capacity).

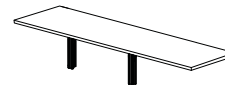

Synergy Triple-Width Shelf

| | |
|-------------------------------------|-----------|
| Black Shelf with 8.5" Aluminum Post | SA/TS10/A |
| Black Shelf with 8.5" Black Post | SA/TS10/B |

| | |
|---------------------------------------|-----------|
| Black Shelf with 17.75" Aluminum Post | SA/TS20/A |
| Black Shelf with 17.75" Black Post | SA/TS20/B |

- Weight Capacity: 75 lbs.
- Inside Dimensions: 62.25"W x 17.5"D x 3/4"



Chameleon In-Cabinet Refrigerator

Factory Installed X1/C-Frame 30 Refrigeration FI/C30/RGK/A

- Compatible with 317, 323, 329, 336, 337, 345, 347, 517 (top bay only) and 617.
- Built into a cabinet bay and hidden to create a first class refreshment center.
- 2.5 Cubic feet capacity.
- Factory Installed



LIGHT UP INTERIORS

See Accent Lighting Systems on page 104

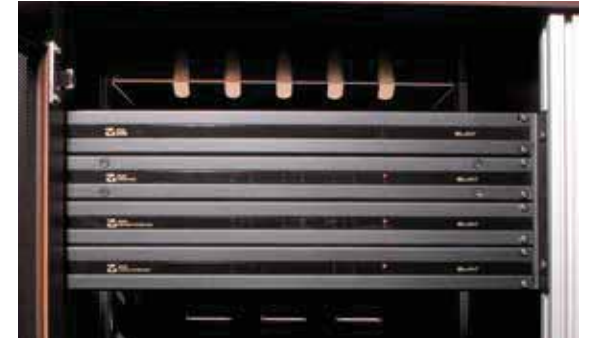

Pull-Out Rack Cartridge

| | |
|---------------------------------|---------|
| 7 U Cartridge for 20" Cabinets | CR7U/F |
| 13 U Cartridge for 30" Cabinets | CR13U/F |

- Integrates with cabinet frame and is easily removable for service.
- Compatible with Synergy and Chameleon cabinets.
- 19" rack with rails front and back of the rack 14" deep.
- Available in two standard heights: 7U configured to fit in a 20" height bay or in a 30" unit utilizing an upper speaker grill opening. 13U configured to fit within a 30" cabinet.
- Cabinet guide rails and in-line caster base provide simple use and transport.
- Tool-less removal / installation for service.
- Flexible cable management wire loom.
- Can be coupled with road cases for off-site service applications.
- Weight capacity 200 lb.
- Threaded for 10-32 screws.
- Rugged 12-gauge powder coated steel construction.

Post Mounted Rack Rail - Full Height

| | |
|--|-----------|
| 10 U Rails for Chameleon 20"H Cabinets | CA/DRM10U |
| 15 U Rails for Chameleon 30"H Cabinets | CA/DRM15U |
| 10 U Rails for Synergy 20"H Cabinets | SA/DRM10U |
| 15 U Rails for Synergy 30"H Cabinets | SA/DRM15U |
| 21 U Rails for Synergy 40"H Cabinets | SA/DRM21U |

- Attaches to cabinet frame posts.
- Compatible with Synergy and Chameleon cabinets.
- Rack rails can be positioned for use with or without a door.
- Threaded for 10-32 screws.
- Includes two, black, powder coated rails per set.

Post Mounted Rack Rail - Component Height

| | |
|------------------|---------|
| 1U Rails, 1.75"H | SA/RM1U |
| 2U Rails, 3.5"H | SA/RM2U |
| 3U Rails, 5.25"H | SA/RM3U |
| 4U Rails, 7"H | SA/RM4U |

- Attaches to front or rear cabinet posts.
- Compatible with Synergy and Chameleon cabinets.
- Doors can be used with component length rails, placed away from hinges.
- Allow for 1.5" clearance for each hinge.
- Includes two, black, powder coated rails per set. Threaded for 10-32 screws.

Rack Cartridge

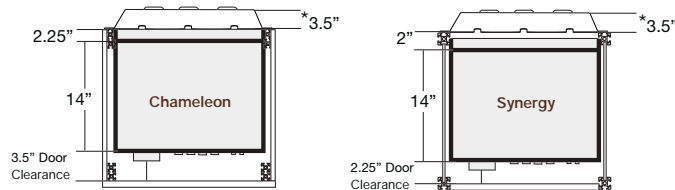

Synergy Post Mounted Rack Rails

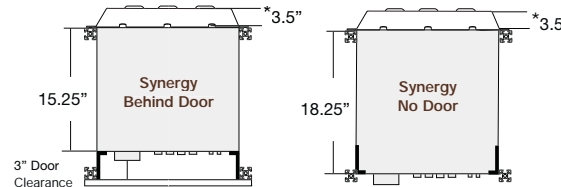

Chameleon Post Mounted Rack Rails

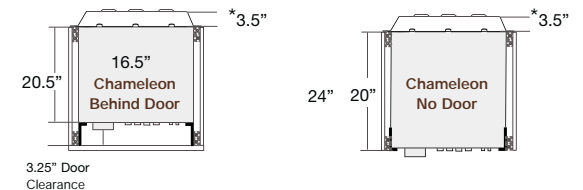

* When using optional Extended Rear Panel, see page 100.



Standard Rack Lacing Bars

Set of 2 RM/LB2

- Mounts to Pull-Out Rack Cartridge and any 19" standard rack.
- Black powder coated steel.



Post Mounted Lacing Bar

Lacing Bar, Black - Set of 3 SA/RMLB

- Mounts to vertical cabinet posts.
- Infinitely adjustable wire management.
- Includes one velcro wrap strap.
- Compatible with Chameleon and Synergy cabinets.
- Black powder coated steel.



Rack Mount Vented Shelf

| | |
|-------------------|----------|
| Vented Shelf - 2U | RM/VS/2U |
| Vented Shelf - 3U | RM/VS/3U |
| Vented Shelf - 4U | RM/VS/4U |

- Mounts to Pull-Out Rack Cartridge and any 19" standard rack.
- 19" EIA standard rack mount, 14" deep, vented shelf.
- Black powder coated steel.
- Max weight capacity of 75lbs



Rack Mount Face Plate

| | |
|------------------------|----------|
| Vented Face Plate - 1U | RM/FP/1U |
| Vented Face Plate - 2U | RM/FP/2U |
| Vented Face Plate - 3U | RM/FP/3U |
| Vented Face Plate - 4U | RM/FP/4U |

- Mounts to Pull-Out Rack Cartridge and any 19" standard rack.
- Features round perforated vent holes.
- Black powder coated perforated steel.



3U Vertical Rack Mount Bracket

3U Vertical Rack Mount Bracket, Wall or Post Fixing RM/VR/3U

- Mounts to vertical cabinet posts.
- 19" EIA standard rack mount.
- Black powder coated steel.
- See cabinet interior dimensions for usable space



Heavy Duty, Fine Floor Casters

| | |
|---------------------|-----------|
| Set of Four, Black | SA/HDC/4 |
| Set of Six, Black | SA/HDC/6 |
| Set of Eight, Black | SA/HDC/8 |
| Set of Ten, Black | SA/HDC/10 |

- Adds 4" to height of cabinet.
- Capacity: 250 lbs. each wheel.
- Dual Wheel swivel casters with brakes.
- Compatible with Chameleon and Synergy cabinets.

Rack Mount Screws

10-32 x 3/4 Mounting Screws (100 Pack) SA/RM/S

- Button Head Cap screw, Black oxide finish.
- Uses 1/8" Allen socket wrench.
- Use with Pull-Out Rack Cartridge and any 19" standard rack.

ACTIVE COOLING & REAR PANELS



Chameleon Bottom In-Take Vent

Active Cooling - Bottom Vent SA/BVAC

- Designed for wall hanging cabinets & compatible with some floor standing cabinets, (clearance required: 2.5" from cabinet bottom to floor.)
- Forced air intake of cool air through cabinet bottom.
- Replaces standard cabinet bottom vent.
- Uses Thermal Trigger*



Chameleon Locking Rear Panels

| | |
|--|------------|
| Factory Installed, Chameleon 30 Locking Rear Panel | FI/C30/LRP |
| Factory Installed, Synergy 30 Locking Rear Panel | FI/S30/LRP |

- Compatible with 317, 323, 336, 337, 345, 347, 517 (top bay only) and 617
- Sold separately.



Extended Rear Panels

| | |
|-----------------------------------|---------|
| 17.75" Extended Rear Panel Black | SA/XR20 |
| 27.75" Extended Rear Panel, Black | SA/XR30 |
| 37.75" Extended Rear Panel, Black | SA/XR40 |

- Add 3.5 inches to cabinet depth - extended Chameleon cabinets to 23.5" and Synergy to 21.5".
- Compatible with Synergy System & Chameleon Cabinets
- **CANNOT BE USED IN CONJUNCTION WITH CHAMELEON TV MOUNTS**

Active Cooling Systems

Automatic, thermostatically controlled operation prevents heat build-up, protecting delicate electronics.



Chameleon Active Cooling Rear Panels

| | |
|---------------------|---------|
| 17.75" Panel, Black | CA/AC20 |
| 27.75" Panel, Black | CA/AC30 |

- Quiet (22 dBA) quad 120 mm fans exhaust warm air.
- Replace standard Chameleon rear panels.
- Includes Thermal Trigger*



*Thermal Trigger for All Active Cooling

- Aluminum back plate for mounting onto walls or cabinets.
- 6 foot water resistant thermal probe
- 4 Temperature settings (84°, 88°, 92°, 96°) plus one always on setting.



Chameleon Extended Rear Panels with Active Cooling

| | |
|------------------------------------|------------|
| 17.75" Active Cooling Panel, Black | SA/XR20/AC |
| 27.75" Active Cooling Panel, Black | SA/XR30/AC |

- Quiet (22 dBA) quad 120 mm fans exhaust warm air.
- Add 3.5 inches (23.5") inside depth to Chameleon cabinets.
- Includes Thermal Trigger*
- **CANNOT BE USED IN CONJUNCTION WITH CHAMELEON TV MOUNTS**



Synergy System Extended Rear Panels with Active Cooling

| | |
|------------------------------------|------------|
| 17.75" Active Cooling Panel, Black | SA/XR20/AC |
| 27.75" Active Cooling Panel, Black | SA/XR30/AC |
| 37.75" Active Cooling Panel, Black | SA/XR40/AC |

- Quiet (22 dBA) quad 120 mm fans exhaust warm air.
- Add 3.5 inches (21.5") inside depth to Synergy cabinets.
- Includes Thermal Trigger*



Power Conditioner Kit

| | |
|---|--------|
| Power Conditioner with Bracket | CA/PCK |
| Mounting Bracket for Chameleon & Synergy Cabinets | CA/PCM |

- Filters AC current to deliver better quality sound and picture.
- Panamax Model # M8AV.
- 8 AC outlets, 2 CATV connectors, 2 pair of satellite connectors, in/out telco connectors with phone line splitter, 8' power cord, accepts add-on signal line modules.
- Bracket Measures: 12"W x 5"H x .125"TH
- Mounts to cabinet interior or exterior.
- Compatible with Synergy System & Chameleon Cabinets



Power Distribution Unit

| | |
|--|-----------|
| 1-U Rack Mounted Power Distribution Unit | SA/RM/PDU |
|--|-----------|

- Requires Rack Rails, see Page 98.
- 8 Filtered & Protected Outlets (Rear) + 1 Front Panel Convenience Outlet
- Power Distribution Unit with surge protection
- Maximum Output Current: 15 Amps
- Line Cords: 6 ft. captive, 14 AWG, with 3-conductor Edison Plug
- Operating Voltage: 120VAC 60HZ
- Spike Protection Mode: Line to neutral
- Energy Dissipation: 170 Joules
- Peak Impulse Current: 12,000 Amps
- Maximum Continuous Operating Voltage: 130 VAC RMS
- Let Through Voltage (@ 125 amps, 8/20uS waveform): 400 volts
- Noise Attenuation (Transverse Mode): Greater than 23db, 200Khz to 10MHz
- Dimensions: 1.75" H x 19" W x 3.75" D
- Weight: 4.9 lbs. (2.2 kg)
- Safety Agency Listing: cTUVus
- Three Year Limited Warranty: Covering defects in materials and workmanship
- Compatible with Synergy System & Chameleon Cabinets



Chameleon Power & USB Ports

| | |
|--|------------|
| Factory Installed 1 AC Power Outlet, 2 USB - Black | FI/PWR/USB |
| Factory Installed 2 AC Power Outlet - Black | FI/PWR/AC |

- Can be installed on any Chameleon cabinet.
- USB Power Rating: 5V DC/CC 700mA
- Cable is pre-wired and requires no electrical wiring by the installer
- ETL listed, UL Rated 817D, CSA STD 22.2 42.1-00
- Receptacle
 - UL Listed Receptacle 351B
 - ETL Listed Assembly
 - Tamper Resistant
 - Power Rating: 15A-125V
- USB
 - Easily charge cell phones/ MP3 player
 - Save space-no adapter required
 - USB Power Rating: 5V DC/CC 700mA
 - Indicator light confirms charging status
- Includes 3ft. Pre-wired Power Cord and Décor Wall Plate



Saturn Wheels

| | |
|------------------------|------------|
| Satin Black, Set of 4 | SA/C/4/BK |
| Satin Black, Set of 6 | SA/C/6/BK |
| Satin Black, Set of 8 | SA/C/8/BK |
| Satin Black, Set of 10 | SA/C/10/BK |

| | |
|-------------------------|---------|
| Satin Chrome, Set of 4 | SA/C/4 |
| Satin Chrome, Set of 6 | SA/C/6 |
| Satin Chrome, Set of 8 | SA/C/8 |
| Satin Chrome, Set of 10 | SA/C/10 |

- Adds 3" to height of cabinet.
- Capacity: 100 lbs. each wheel.
- Wheels rotate 360° and include brake.
- Metal wheel with non-marking rubber ring.



Heavy Duty Casters

| | |
|------------------|-----------|
| Set of 4, Black | SA/HDC/4 |
| Set of 6, Black | SA/HDC/6 |
| Set of 8, Black | SA/HDC/8 |
| Set of 10, Black | SA/HDC/10 |

- Adds 4" to height of cabinet.
- Capacity: 250 lbs. each wheel.
- Dual Wheel swivel casters with brakes.



Chameleon Tapered Wood Feet

| | |
|-----------------|------------|
| Set of 4, Black | CA/BF/4/BK |
| Set of 5, Black | CA/BF/5/BK |
| Set of 6, Black | CA/BF/6/BK |

- Adds 3.25" to height of cabinet.
- Solid hardwood with adjustable levelers.
- Capacity: 125 lbs. each foot.



Chameleon Low Profile Wood Feet

| | |
|--------------------|------------|
| Set of 4, Espresso | CA/BF2/4/E |
| Set of 5, Espresso | CA/BF2/5/E |
| Set of 6, Espresso | CA/BF2/6/E |
| Set of 4, Black | CA/BF2/4/B |
| Set of 5, Black | CA/BF2/5/B |
| Set of 6, Black | CA/BF2/6/B |

- Adds 1.25" to height of cabinet.
- Solid hardwood with adjustable levelers.
- Capacity: 125 lbs. each foot.



Stiletto Feet

| | |
|-----------------------|----------|
| Matte Black, Set of 4 | SA/SFB/4 |
| Matte Black, Set of 6 | SA/SFB/6 |
| Matte Black, Set of 8 | SA/SFB/8 |

| | |
|------------------------|----------|
| Matte Silver, Set of 4 | SA/SFA/4 |
| Matte Silver, Set of 6 | SA/SFA/6 |
| Matte Silver, Set of 8 | SA/SFA/8 |

- Adds 6" to height of cabinet.
- Capacity: 150 lbs. each foot.
- Machined anodized aluminum.



Claw Feet

| | |
|-----------------------------|---------|
| Set of 4, Polished Aluminum | SA/AF/4 |
| Set of 6, Polished Aluminum | SA/AF/6 |
| Set of 8, Polished Aluminum | SA/AF/8 |

- Adds 3" to height of cabinet.
- Capacity: 150 lbs. each foot.
- Hand polished cast aluminum.



Robot Feet

| | |
|-----------------|----------|
| Set of 4, Black | SA/RFB/4 |
| Set of 6, Black | SA/RFB/6 |
| Set of 8, Black | SA/RFB/8 |

- Adds 3" to height of cabinet.
- Capacity: 150 lbs. each foot.
- Machined anodized aluminum.



Chameleon Steel Tube Core

| | |
|----------------------------------|-----------|
| For Twin Cabinets, Matte Black | CA/TB/N/B |
| For Triple Cabinets, Matte Black | CA/TB/L/B |
| For Quad Cabinets, Matte Black | CA/TB/Q/B |

- Adds 5" to height of cabinet.
- Features adjustable levelers.
- Capacity: 600 lbs.
- Powder-coated welded steel tube.

Decorator Feet and Wheels fine-tune the style and function. We offer a variety of cabinet feet and casters to replace standard cabinet feet.

ORDERING FOOTING

| | |
|------------------------|-----------|
| Chameleon Single-Width | Set of 4 |
| Chameleon Twin-Width | Set of 4 |
| Chameleon Triple-Width | Set of 8 |
| Chameleon Quad-Width | Set of 6 |
| Synergy Single-Width | Set of 4 |
| Synergy Twin-Width | Set of 6 |
| Synergy Triple-Width | Set of 8 |
| Synergy Quad-Width | Set of 10 |



• Wheels, Feet, & Bases are NOT compatible with Barcelona and Corsica styles.



Leveler Feet

| | |
|-----------------|---------|
| Set of 4, Black | CA/LF/4 |
|-----------------|---------|

- Adds 1.25 - 1.75" to height.
- Capacity: 150 lbs. each foot.
- Steel with polyethylene pad.



Chameleon Wall Mounting Kits

| | |
|-------------------------------|--------|
| For Single 217 Cabinets | CU/WK1 |
| For Twin 221 Cabinets | CN/WK1 |
| For Triple 236 & 237 Cabinets | CL/WK1 |
| For Quad 247 & 245 Cabinets | CQ/WK1 |

- Simple DIY Installation mounts to wood or masonry wall construction.
- Replaces standard feet and allows cabinet to hang from wall.
- Powder-coated steel brackets.

! Not compatible with 30" Cabinets or Barcelona & Corsica styles.

Synergy Wall Mounting Kits

| | |
|---|--------|
| For Single 217 Cabinets | SU/WK1 |
| For Twin 221 Cabinets | SN/WK1 |
| For Triple 132, 133, 236 & 237 Cabinets | SL/WK1 |
| For Quad 147 & 247 Cabinets | SQ/WK1 |

- Simple DIY Installation mounts to wood or masonry wall construction.
- Replaces standard feet and allows cabinet to hang from wall.
- Powder-coated steel brackets.

Wall hanging cabinets are the ultimate way to create the look of custom cabinetry, with the illusion that your cabinet is floating above the floor. Best of all, installation is simple. Just remove the standard cabinet feet, install the specialized wall hanging brackets and presto!

- Powder-coated steel brackets.
- Replaces standard feet and allows cabinet to hang from wall.
- Simple DIY Installation mounts to wood or masonry wall construction.

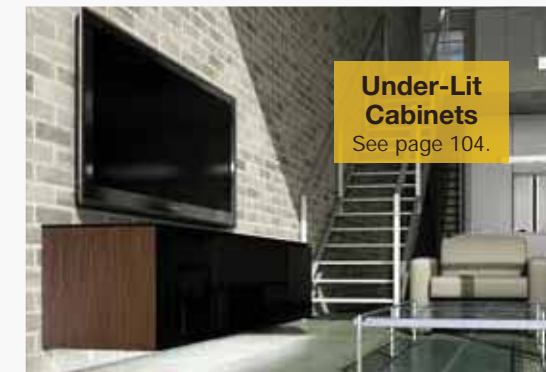

Compatible Models



217

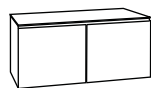

221

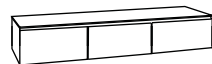

132 & 133

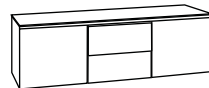

236

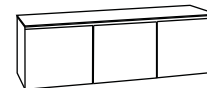

237

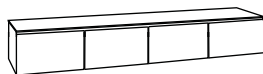

147

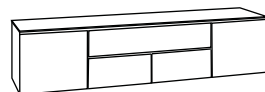

245

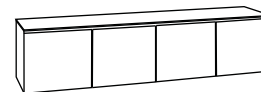

247

Load Capacity

| Models | Equipment Load Capacity |
|-----------------|-------------------------|
| CU/WK1 & SU/WK1 | 50 lbs. |
| CN/WK1 & SN/WK1 | 50 lbs. |
| CL/WK1 & SL/WK1 | 150 lbs. |
| CQ/WK1 & SQ/WK1 | 200 lbs. |



Accent Lighting System

Lighting System with Two 15" Bars SD/LS2/W

- Adjustable Color Temperature: Cool to Warm 3200-6500K
- Expandable hub for up to 4 additional LED light bars
- 15" & 24" LED light bars also available
- Full dimming and brightness control
- Breath and sleep modes
- Infrared remote control
- Up to 3 memory settings
- Compatible with Synergy System & Chameleon Cabinets

Lighting Expansion

15" Light Bar Expansion Kit SD/LSX15/W

24" Light Bar Expansion Kit SD/LSX24/W



All In One IR Repeater

IR Repeater Kit SD/IR

- Allows Infrared remote to control electronics behind closed wooden doors
- Complete kit includes; 2 plugs / 4 IR Emitters, wire management accessory, power supply and mounting hardware for Chameleon, Synergy and other wood cabinets



IR Flasher, Dual-Head Emitter

Black SD/IRX2

- Increases the capacity of the SD/IR by splitting two emitters from one plug



Chameleon Locking Rear Panels

Factory Installed Chameleon 30 Locking Rear Panel FI/C30/LRP

- Compatible with 317, 323, 329, 336, 337, 345, 347, 517 (top bay only) and 617
- Sold separately

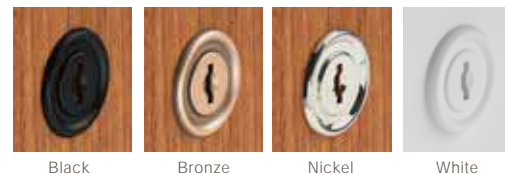

Door Locks

Factory Installed Chameleon Door Lock - Black FI/C/DL/BK

Factory Installed Chameleon Door Lock - Bronze FI/C/DL/BZ

Factory Installed Chameleon Door Lock - Nickel FI/C/DL/NK

Factory Installed Chameleon Door Lock - White FI/C/DL/WH

Factory Installed Synergy Door Lock - Black/Nickel FI/SD/LOCK

DIY Synergy Door Lock Kit - Black/Nickel SD/LOCK

- Locks CANNOT be added to Glass front doors.



DIY Synergy Door Lock Kit (SD/LOCK)

SADDLE

TABLET HOLDER



The innovative tablet Bean Bag Stand features a convenient mounting interface. The handmade, real leather bag easily conforms to any flat or irregular surface to provide a leveled viewing angle.

- Luxurious / Premium handmade leather bean bag
- Soft and non-marring so it's great for kids and furniture
- Stable in any position on virtually any surface
- Filled with eco-friendly, recycled pellets
- Visit SalamanderDesigns.com for the latest models



Creme Pearl
TS1/L/CM



Charcoal Pearl
TS1/L/CL



Graphite
TS1/L/GT



Mushroom
TS1/L/MR



Parquet
TS1/L/PQ



Red
TS1/L/RD



Creme/Charcoal
TS1/L/CMCL



Parquet / Mushroom
TS1/L/PQMR



Red/Graphite
TS1/L/RDGT

CUSTOM SEATING

Entertainment seating is one of the most critical elements of a media room. That is why every piece of Salamander seating is constructed with the highest degree of strength, style and comfort. Our seating collections reflect a love of modern design, with simple, refined lines and functional forms. Salamander's advanced, flexible seating solutions more than measure up.

Our bench made home theater seating is **hand built & shipped in 30 business days**, enabling you to enjoy your furniture sooner than later.



BUILT TO LAST

RELAX...IT'S BUILT TO LAST

Our unique suspension system provides comfort and long-lasting support. It combines traditional springs and modern elastic webbing with the highest quality resilient virgin polyurethane foam. Cushions are cut to shape, wrapped with a layer of memory foam and covered with a layer of polyester padding before covering. This prevents cushions from packing down and losing their shape over time.

Seating frames are constructed of top-grade plywood that flexes and recovers without cracking. Joints are crafted with mortise-and-tenon construction for greater strength and durability. Only American-made, commercial-grade mechanisms are used, and higher gauge steel assures exceptional durability and reliability. Powered chairs have quiet motorized controls and infinitely variable stops to find the perfect position. No shortcuts...no compromises.

The key to seating ergonomics is to have the right support in the right place. Watching a movie can be an hours long experience, so proper support is essential.



DESIGN YOUR OWN



THE PERFECT SEATING SOLUTION

The innovative modular design of all Salamander seating styles means your options are endless.

Suit your space, taste and needs to enhance the comfort and enjoyment of your home theater experience in just a few steps.

Custom design your home theater room with our user-friendly DESIGN YOUR OWN configurator, SalamanderDesigns.com/DYO.



STYLE

Choose yours.

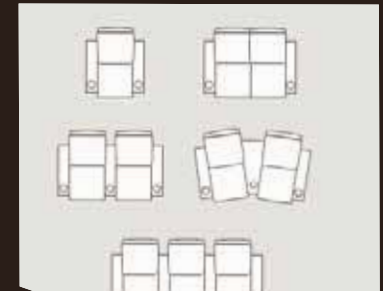

MODULAR

Configure loveseats, straight or curved rows of seating by combining chair modules.



MECHANISM

Opt for a quiet powered or manual mechanism and recline in ultimate comfort.



COVERS

Select from a wide selection of premium leathers and durable fabrics with stitching options.



Supply Your Own
Cover Material
Call for Details

PREMIUM SEATING MATERIALS

Choose the Salamander Seating material that fits your style, room and lifestyle like a glove. Our durable, premium, top grain leathers and fabrics are intensely pleasing to the eye and touch.

Go to SalamanderDesigns.com to request swatch samples.

CUSTOM DETAILS



CONTRAST PIPING

Perfect for creating a refined, sophisticated and personalized look. Available on some styles (color combinations must be within the same leather group).

CONTRAST STITCHING

Accentuate the fine detail on your custom handmade seating. Available on some styles (ivory or gray stitch, dependant on color selected).



SURFACE

Swivel tablets easily install into cup holders to provide handy surfaces.



PILLOWS

Matching lumbar pillows provide additional support, available in any leather or Microsuede.



CUP HOLDER

Recessed, with option for black or silver anodized aluminum.
2-7/8 Diameter



VIBRATION

Experience the natural percussive impact of movie sounds with Sound Transducers that produce a full range of frequency vibrations.

PREMIUM LEATHER LUSTRA

Full hides of supple, top-grain steer leather are carefully selected, dyed and top coated for added protection. Lustra's soft hand and classic character are reminiscent of Old English bridle.

PREMIUM LEATHER ROYAL

Fine Italian, aniline dyed leather with a soft and supple hand. Fine graining enhances Royal's beauty and gives it a warm, cozy appeal.

Whiskey

Hershey

Harness Brown

Olive

Iron Gate

Castle Gate

Cashmere

Cognac

True Black

Cinnamon

Midnight Blue

Safari

PREMIUM LEATHER

VINTAGE

Full-grain, aniline-dyed steer hides are selected for an excellent soft hand and drape. The age-distressed look, natural markings and color variants give each Vintage chair a unique, authentically rustic look.

PREMIUM LEATHER

LUXE

American dairy cowhide is meticulously selected for a natural, even, pebbled grain. Luxurious looking with excellent durability, Luxe is recommended for the contract, hospitality and residential markets.

Acorn

Bark

Hazelnut

Oatmeal

Pewter

Oyster

Adirondack

Merlot

Mushroom

Go to SalamanderDesigns.com
to request swatch samples.

Onyx

Mariner

Alabaster

TOP GRAIN LEATHER EARTH

Ultra-supple, top-grain cowhide with excellent durability, deep color and incredibly soft touch. Easy to clean, Earth leathers are an ideal choice for families with children or pets. Available in a range of colors.

Snow
(Piping Only)

Canyon

Chocolate

Redrock

Desert

Sand

Terrain

Stout

Cabernet

Eclipse

Ruby

Limestone

Charcoal

Pistachio

Fog

Anchor

FABRIC SERENE

Serene offers the best of all worlds: a soft to the touch, durable fabric that drapes well and wears even better. 100% Polyester, Serene is an easily cleaned seating material that has the wear resistance you'll appreciate. Competitively priced and available in a wide range of stylish, on trend colors, Serene is one of our customers favorite textile seating materials.

FABRIC

VELUTO

Soft to the touch, like modern day velvet. Reminiscent of old time theaters, Veluto takes a classic style and amps it up with a contemporary look and feel for a perfect blend of comfort and style.

Veluto only available for Olivia and Jumpseat

FABRIC

MICROSUEDE

Exceptional value, attractive looks and growing in popularity. This 100% Micro denier fabric's soft feel, smooth nap, durability and easy cleaning make it an ideal choice for today's busy lifestyles.

Slate

Root Beer

Flax

Mocha

Espresso

Stone

Moss

Putty

Go to SalamanderDesigns.com
to request swatch samples.

Brandy

Black

Sage



Royal Iron Gate with Contrasting Stitch



DIAMOND PATTERN

LUCA

With its distinctly European style, Luca features transitional design with **diamond-shaped pattern** and double-needle stitching. Elegant, roomy, and comfortable, Luca Theater Seating is perfect for your home theater.



MODULES

End chairs combine with chair connectors or armless chairs for straight or wedge shaped rows.
Two armless Luca modules can be joined without arm connectors.

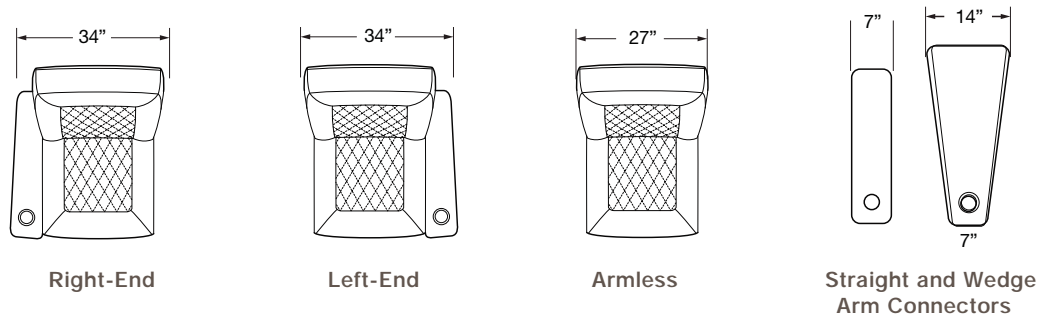

SPECIFICATIONS

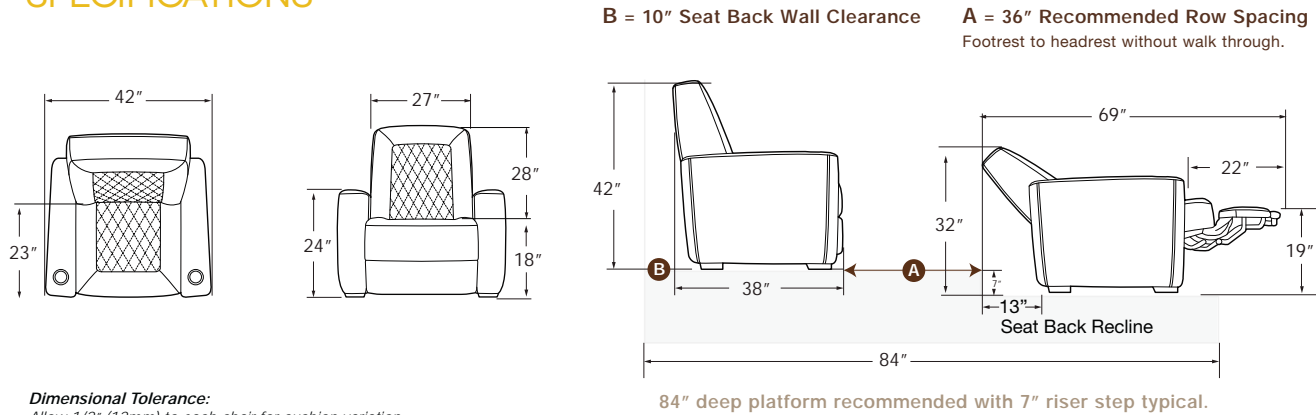

Dimensional Tolerance:
Allow 1/2" (12mm) to each chair for cushion variation.

MODULAR SOLUTIONS

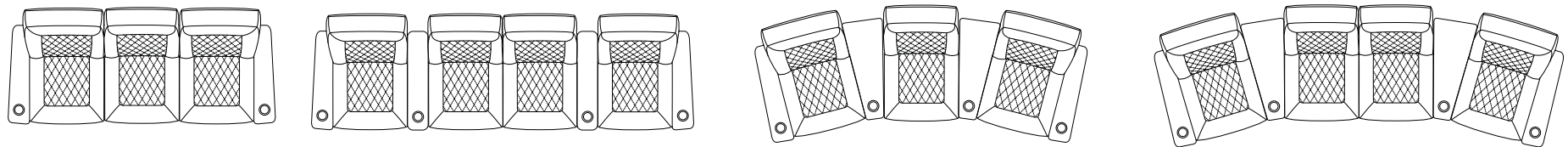

- Wall-away recliner mechanism allows close-to-wall positioning
- Fully-adjustable, motorized* recliner or 3-position manual recliner mechanism
- Leather or microsuede covers
- Tailored, optional contrast double needle stitch
- Black, silver or no cup holder

* Power Mechanism Electrical Specifications: 110 V AC, 2.0 amps nominal load, 5.0 amps max load, thermally protected



Design & Quote Custom Theater Seating Online with our **Custom Configurator**
SalamanderDesigns.com



HORIZONTAL PATTERN

LILLIANA

Large and comfortable, Lilliana theater seating combines transitional style with a distinctive retro flair. Lilliana theater seating -- with generous cushioning and large arms -- invites you to be seated in lavish comfort.



MODULES

End chairs combine with chair connectors or armless chairs for straight or wedge shaped rows.
Two armless Lilliana modules can be joined without arm connectors.

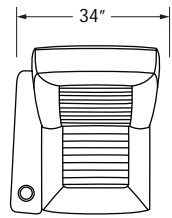

Right-End

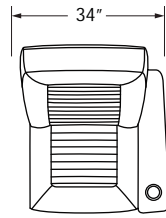

Left-End

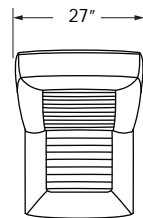

Armless

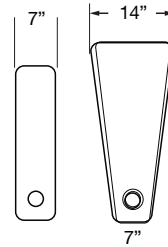

Straight and Wedge
Arm Connectors

SPECIFICATIONS

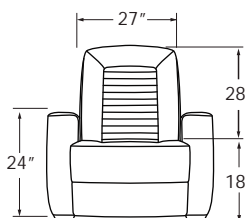
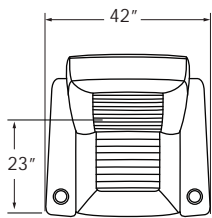

B = 10" Seat Back Wall Clearance

A = 36" Recommended Row Spacing
Footrest to headrest without walk through.

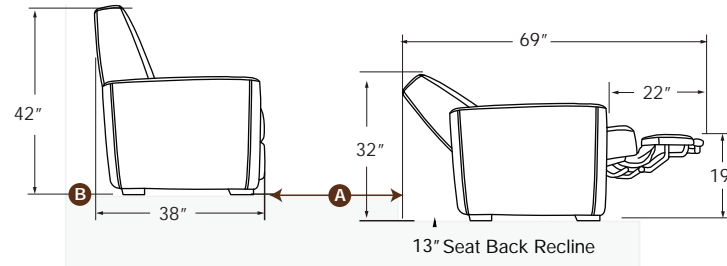

84" deep platform recommended with 7" riser step typical.

Dimensional Tolerance:

Allow 1/2" (12mm) to each chair for cushion variation.

MODULAR SOLUTIONS

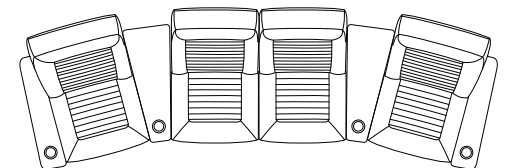
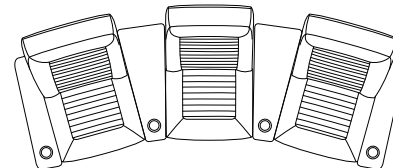
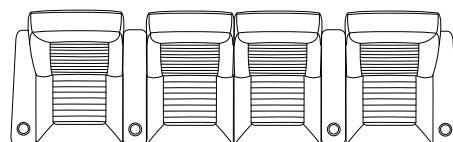
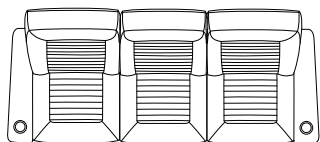

- Wall-away recliner mechanism allows close-to-wall positioning
- Fully-adjustable, motorized* recliner or 3-position manual recliner mechanism
- Leather or Microsuede covers
- Tailored, piping with optional contrast piping
- Black, silver or no cup holder

* Power Mechanism Electrical Specifications: 110 V AC, 2.0 amps nominal load, 5.0 amps max load, thermally protected



Design & Quote Custom
Theater Seating Online with
our **Custom Configurator**
SalamanderDesigns.com



Royal Cognac with Cashmere Piping

ISABELLA

Heads turn when Isabella's in the room. Updated, traditional style with fine tailoring and subtle curves beckon from all angles. Obsessive attention to detail shows in the precise stitching, tailored piping, handsome roll arms and advanced ergonomics.



MODULES

End chairs combine with chair connectors or armless chairs for straight or wedge shaped rows.
Two armless Isabella modules can be joined without arm connectors.

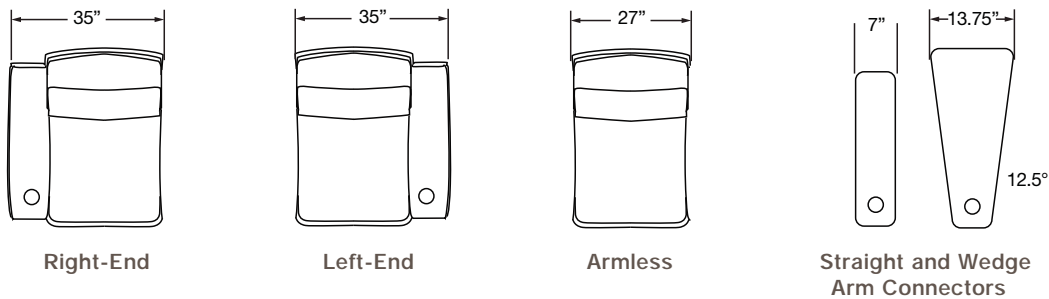

SPECIFICATIONS

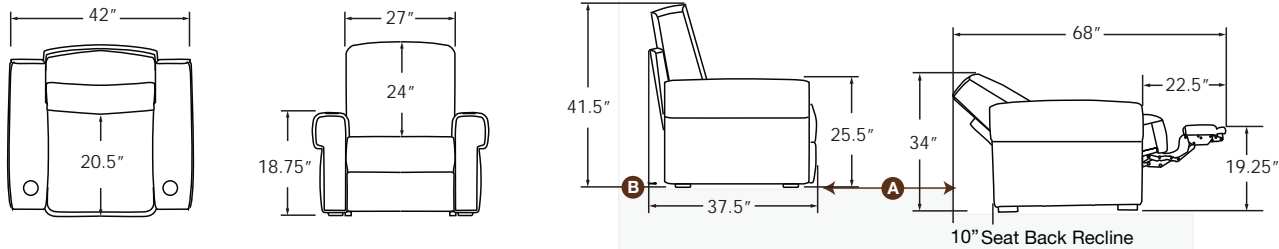

83.5" deep platform recommended with 7" riser step typical.

Dimensional Tolerance:
Allow 1/2" (12mm) to each chair for cushion variation.

- Wall-away recliner mechanism allows close-to-wall positioning
- Fully-adjustable, motorized* recliner or 3-position manual recliner or non-reclining mechanism
- Leather or Microsuede covers
- Tailored, piping with optional contrast piping
- Black, silver or no cup holder

* Power Mechanism Electrical Specifications: 110 V AC, 2.0 amps nominal load, 5.0 amps max load, thermally protected



Design & Quote Custom Theater Seating Online with our **Custom Configurator**
SalamanderDesigns.com

MODULAR SOLUTIONS

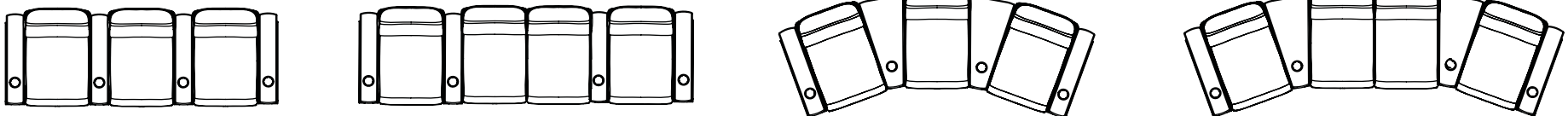



Chocolate Earth and Putty Microsuede

OLIVIA

More than the ideal choice for a dedicated home theater, Olivia is perfect for today's media room, family room or great room. Chaise and corner connectors easily create cozy "L"-shaped sectionals while straight connector arms allow typical theater rows. Stylish two-tone covers provide even greater design personalization.



MODULES

End chair, chaise or corner modules combine with chair connectors or armless chairs for straight rows or sectionals.
Two armless or chaise Olivia modules can be joined without arm connectors.

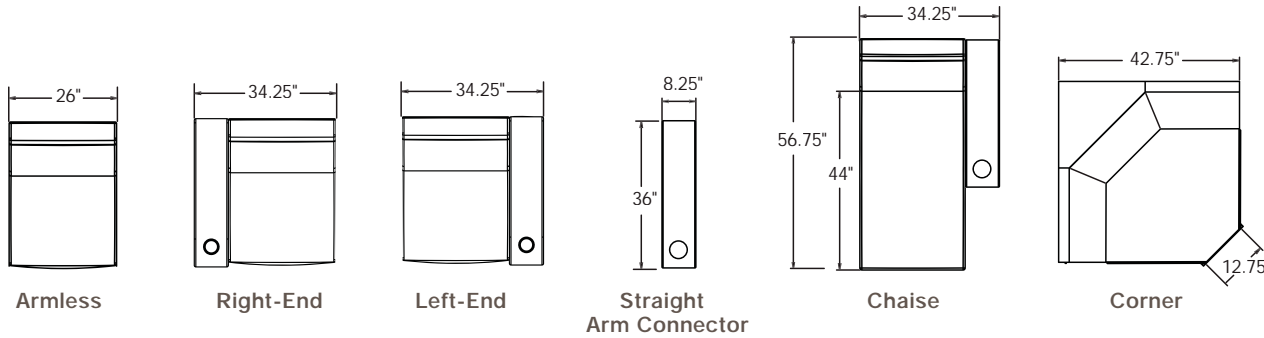

SPECIFICATIONS

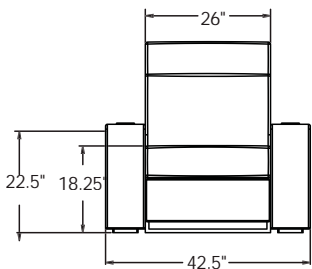

Dimensional Tolerance:
Allow 1/2" (12mm) to each chair for cushion variation.

B = 4" Seat Back Wall Clearance

A = 37" Recommended Row Spacing
Footrest to headrest without walk through.

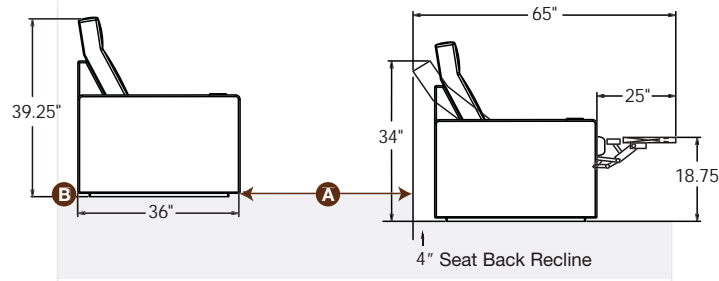

77" deep platform recommended with 7" riser step typical.

MODULAR SOLUTIONS

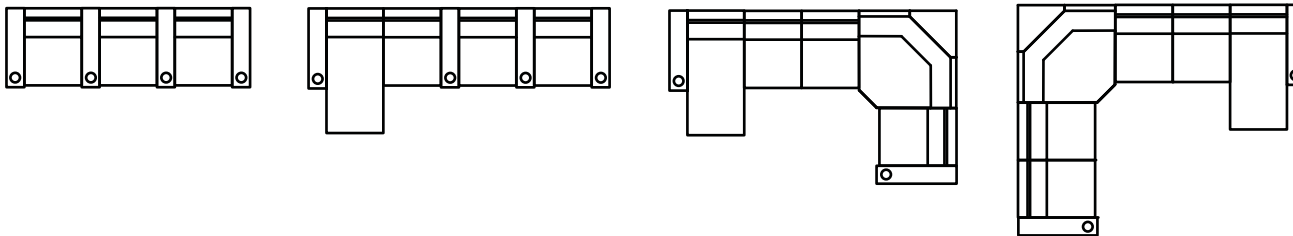

- Wall-away recliner mechanism allows close-to-wall positioning
- Fully-adjustable, motorized* recliner or 3-position manual recliner or non-reclining mechanism
- Corner section is non-reclining and includes 3 loose pillows
- Chaise section is non-reclining
- Personalize by choosing between stylish two-tone leather & Veluto fabric seats or full fabric in Veluto or Serene.
- Tailored, double-needle stitch with optional contrast stitching
- Black, silver or no cup holder

* Power Mechanism Electrical Specifications: 110 V AC, 2.0 amps nominal load, 5.0 amps max load, thermally protected



Design & Quote Custom Theater Seating Online with our **Custom Configurator**
SalamanderDesigns.com

Now available in full fabric
Choose from Veluto or Serene



TALIA

Generous cushioning and graceful, Modern-inspired curves invite you to be seated while the reclining back and hidden footrest support you in lavish comfort.



MODULES

End chairs combine with chair connectors or armless chairs for straight or wedge shaped rows.
Two armless Talia modules can be joined without arm connectors.

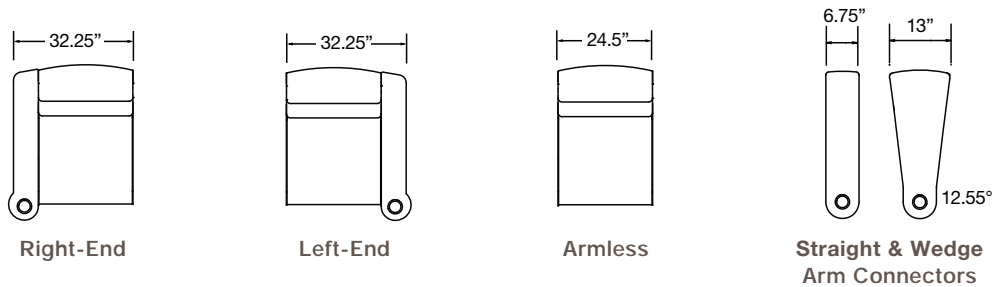

SPECIFICATIONS

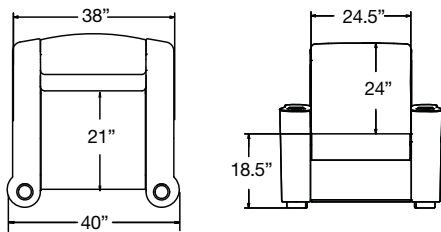

B = 3" Seat Back Wall Clearance **A = 36" Recommended Row Spacing**
Footrest to headrest without walk through.
(Measured with chair in upright position)

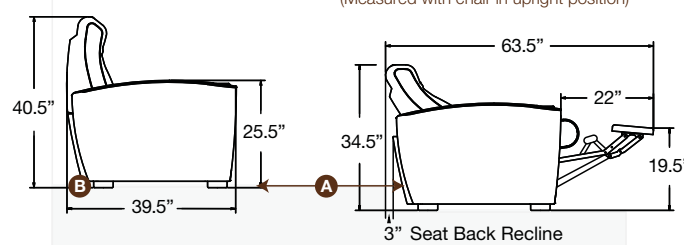

78.5" deep platform recommended with 7" riser step typical.

Dimensional Tolerance:
Allow 1/2" (12mm) to each chair for cushion variation.

MODULAR SOLUTIONS

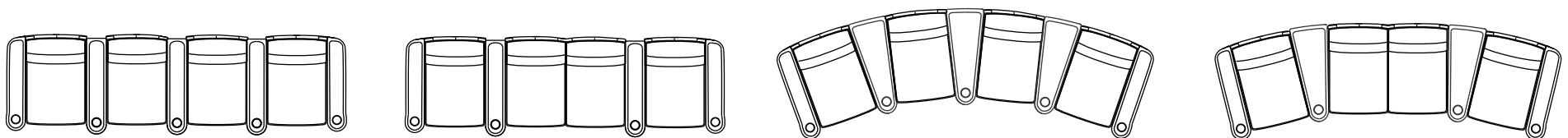

- Wall-away recliner mechanism allows close-to-wall positioning
- Fully-adjustable, motorized* recliner or 3-position manual recliner or non-reclining mechanism
- Leather, Serene, or Microsuede covers
- Tailored, piping with optional contrast piping
- Black, silver or no cup holder

* Power Mechanism Electrical Specifications: 110 V AC, 2.0 amps nominal load, 5.0 amps max load, thermally protected



Design & Quote Custom Theater Seating Online with our **Custom Configurator**
SalamanderDesigns.com



MATTEO

Matteo provides the comfort of a large, embracing chair on a relatively small footprint. This is a great benefit in applications where a large number of seats must fit into a limited space.



MODULES

End chairs combine with chair connectors or armless chairs for straight or wedge shaped rows.
Two armless Matteo modules can be joined without arm connectors.

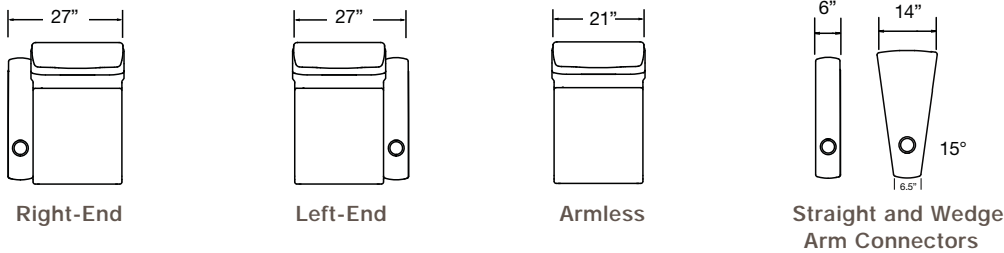

SPECIFICATIONS

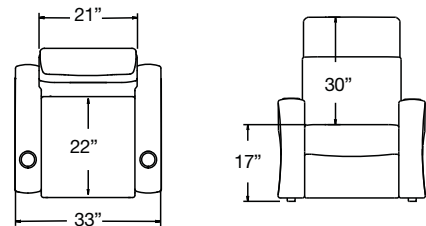

B = 24" Seat Back Wall Clearance

A = 44" Recommended Row Spacing
Footrest to headrest without walk through.

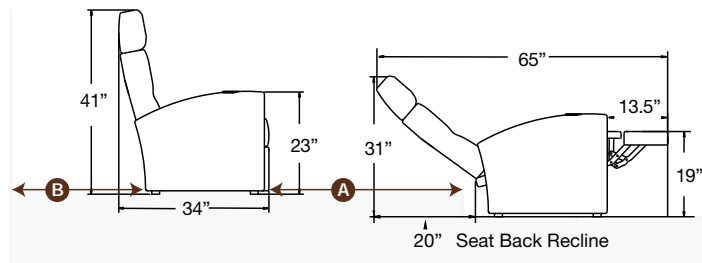

Dimensional Tolerance:
Allow 1/2" (12mm) to each chair for cushion variation.

- Small footprint with premium comfort
- Adjustable headrest for just-right support
- Fully-adjustable, motorized* recliner or 3-position manual recliner or push on arm non-reclining recliner
- Leather, Serene, or Microsuede covers
- Tailored, double-needle stitch with optional contrast stitching
- Black, silver or no cup holder

* Power Mechanism Electrical Specifications: 110 V AC, 2.0 amps nominal load, 5.0 amps max load, thermally protected



Design & Quote Custom Theater Seating Online with our **Custom Configurator**
SalamanderDesigns.com

MODULAR SOLUTIONS

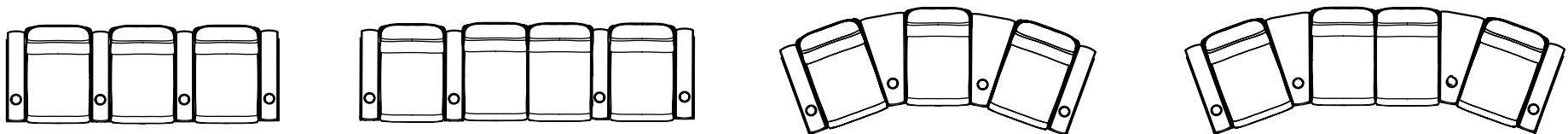



Earth - Ruby Leather

Hazelnut - Vintage Leather

ALEX

Inspired by the classic club chair, the Alex's swooping arms and low-slung profile give it a sensuous style with timeless appeal. It's low seat back enables a full surround sound experience, making this the perfect audiophile listening chair. A unique incline mechanism provides elevated leg support, while maintaining an upright seat back position. This thoughtful design ensures a heightened sensory experience.



MODULES

End chairs combine with chair connectors or armless chairs for straight or wedge shaped rows.
 Two armless Alex modules can be joined without arm connectors.

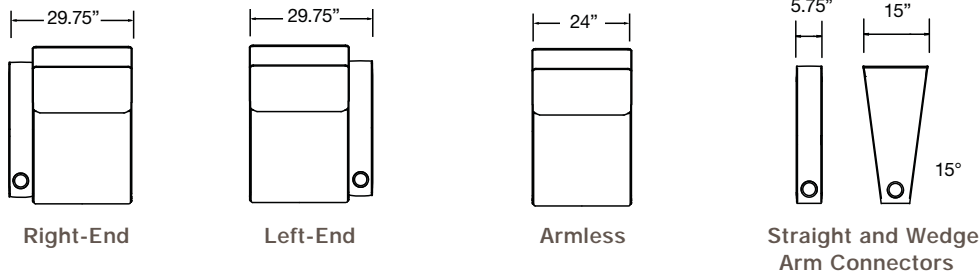

SPECIFICATIONS

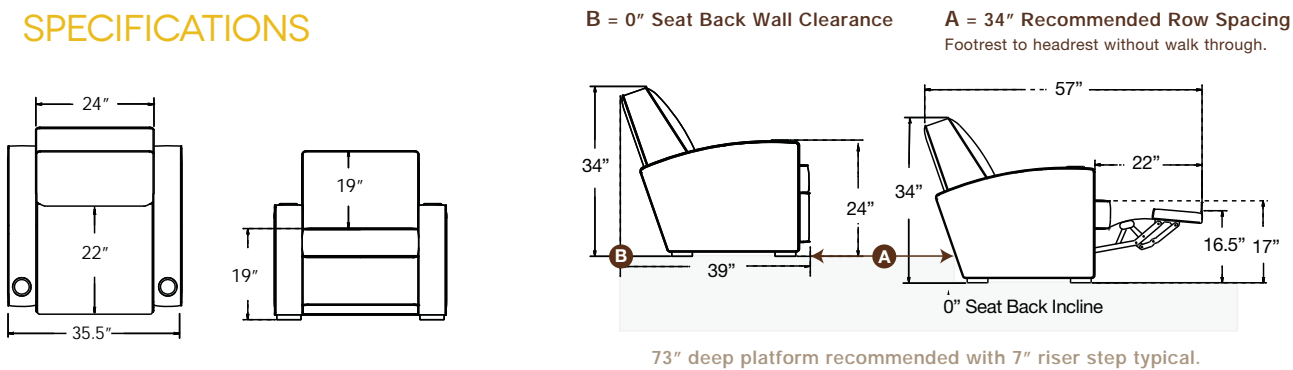

Dimensional Tolerance:
 Allow 1/2" (12mm) to each chair for cushion variation.

MODULAR SOLUTIONS

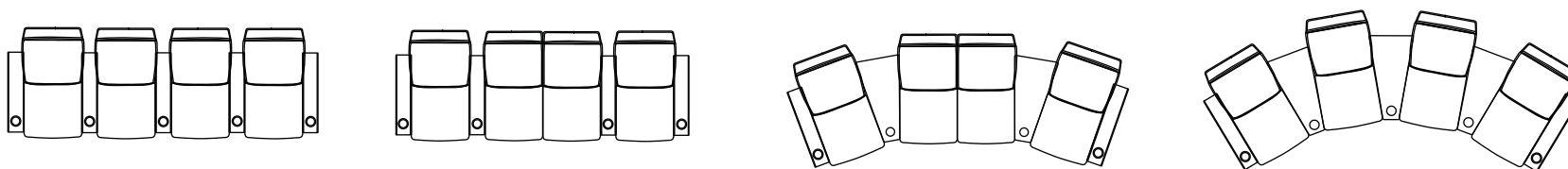

- Wall-away incline manual or powered mechanism* provides elevated leg support, while maintaining an upright seat back position
- Leather, Serene, or Microsuede covers
- Tailored, piping with optional contrast piping
- Black, silver or no cup holder

* Power Mechanism Electrical Specifications: 110 V AC, 2.0 amps nominal load, 5.0 amps max load, thermally protected



Design & Quote Custom Theater Seating Online with our **Custom Configurator**
SalamanderDesigns.com



OTTOMANS, TABLES, PILLOWS & MORE



Custom Jumpseat Ottoman

- One minute it's an ottoman, but open it up and it becomes a comfortable, fully cushioned seat with storage compartment.
- Customize with your choice of leather or Veluto exterior with a Veluto interior seat with or without silver or black cupholders.
- Seat measures: 22"W x 17"D

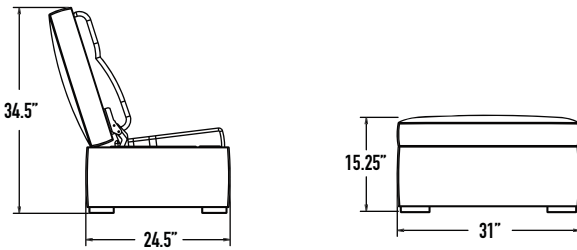

Custom and Standard Jumpseat Specifications.



Clark Synthesis Tactile Sound Transducer

Clark Synthesis #239, Black TST239

- Requires an amplifier.
- Produces a full range of frequency vibrations, allowing you to experience the natural percussive impact of movie sounds.
- Simple installation, mounting stud pre installed in seat.
- 8" in diameter.
- Continuous Power Handling: 100 watts, Impedance: 4 ohms, Overload Protection: Polyswitch, Frequency Response: 15Hz to 17KHz
- Recommended amp 150 - 250 watts



Storage Ottoman

- One minute it's an ottoman, but open it up and it becomes a roomy storage container.
- Dark Gray Interior
- Interior Storage Measures: 24.5"W x 20.5"D

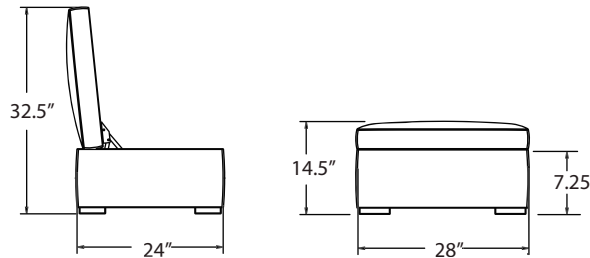

Cache End-Table

- Dark Gray Interior
- Dark Walnut Wood Veneer Top with Leather Pull
- Dark Solid wood feet

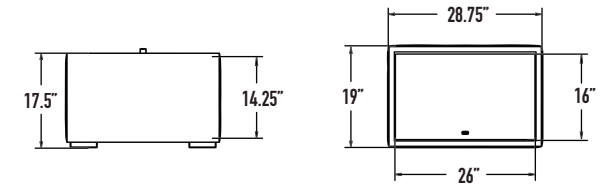

Swivel Tablet

Black STB/B

- Removable tablet that simply installs into any cup holder to serve as a personal surface.
- Measures 20"W x 12.5"D x .75"TH.
- Capacity of 7 lbs.
- Not compatible with AV Basics Seating



Powered Chair Battery Pack

Battery Pack BP1

- 24 Volt Nickel-metal hydride rechargeable battery
- Enables powered chairs to be used in areas without outlets
- 200 Open / Close cycles

Lumbar Pillows

- Pillow One Measures 24.5"W x 9.5"H
- Pillow Two Measures 22"W x 22"H
- Pillow Three Measures 22"W x 16"H



Pillow One

Pillow Two

Pillow Three



AV BASICS

CABINETS



QUALITY & VALUE

Based on twenty years of experience, we defined a line that combines popular styles with features we know will enhance the performance of most audio/video systems.

These are high quality pieces of furniture in enough styles that everyone will find something to fit their décor. The performance is built in, and best of all, they quick ship to you fully assembled.



QUALITY CONSTRUCTION

Solid, high-quality, fully assembled cabinets with premium hardware.



IR PASS-THRU

Remote-friendly glass doors allow pass-thru for remote control of electronics.



WIRE MANAGEMENT

Removable rear panels and cable raceways make managing and concealing cables easy.



VENTILATION

Built-in ventilation louvers keep gear cool to ensure optimal performance.



QUICK SHIP

Ships fully assembled within 3-5 days.





SDAV1

This classic American style in Matte Black or Warm Cherry fits comfortably in almost any decor. Framed wooden doors with integrated mullions and glass panes complete the aesthetic.



SDAV1 5031

50"W x 31"H x 22.5"D

Black

SDAV1/B

Interior: includes two adjustable shelves

Upper Opening: 43"W x 6.8"H x 19.3"D

Door (each bay): 19.25"W x 16.6"H x 18"D

Capacities: TVs up to 55"

Top: 100 lbs.

Upper opening: 75 lbs.

Each Interior Shelf: 50 lbs.



SDAV1 6626

66"W x 26"H x 20"D

Black with Glass Doors

SDAV1/6626/B

Interior: includes six adjustable shelves

Outer Doors (each bay): 19.3"W x 20.75"H x 16.5"D

Center Door: 19"W x 20.75"H x 16.5"D

Capacities: TVs up to 75"

Top: 200 lbs.

Each Interior Shelf: 50 lbs.

SDAV2

This sleek, sophisticated design features recessed glass top and cabinet door fronts complemented by thick, wooden side panels in a Wenge Espresso finish.



SDAV2 7224 72"W x 24"H x 20"D
 Wenge Espresso with Black Glass Doors SDAV2/7224/W

Interior: includes two adjustable shelves
 Center Opening: 28"W x 8"H x 18.8"D
 Center Flip-Down Door: 28"W x 9.75"H x 18.8"D
 Outer Door (each bay): 20"W x 19"H x 18"D

Capacities: TVs up to 80"
 Top: 200 lbs.
 Upper Opening: 50 lbs.
 Each Interior Shelf: 50 lbs.

SDAV5



Subdued, with nice character and details. Finger pulls add to a very clean look, and wide center opening accommodates large speakers. Medium Walnut or Black Oak finish.



SDAV5 7225 72"W x 25"H x 21"D
 Black Oak with Smoked Glass Doors SDAV5/7225/BO
 Medium Walnut with Smoked Glass Doors SDAV5/7225/MW

Interior: includes two adjustable shelves
 Doors (each bay): 20.7"W x 17"H x 18.5"D
 Center Opening: 26.4"W x 8.2"H x 17.1"D
 Center Drawer: 22.87"W x 6.77"H x 15.43"D

Capacities: TVs up to 80"
 Top: 80 lbs.
 Center Opening: 30 lbs.
 Each Interior Shelf: 20 lbs.



AV BASICS

THEATER SEATING



MECHANISM

Electric Motorized Recliner.
In-arm control on end arm seats
and between seats on center seats.



COVER MATERIAL

Construct™ by Salamander Designs, a manufactured leather engineered for upholstery, is available in an attractive, durable and easily cleaned textured black grain finish. Construct™ is designed for regular, everyday use.



USB Charging Port

All TC3 chairs features an in-arm USB port (5V at 2A) and controls for power recline.



QUICK SHIP & ASSEMBLY

Enjoy your furniture sooner than later. AV Basics Seating are in stock and ready to ship from Connecticut. Easy Clip Assembly.



WARRANTY

Limited three year non-transferable warranty on frame, springs & recline mechanism, one year on electrical components and all cover material.

The TC3 offers comfort, style and value. Proper ergonomic design, generous padding and quality materials ensure maximum comfort that performs over time. This motorized recliner will please every member of the family, ensuring total comfort hour after hour spent enjoying favorite movies and sporting events. The cup holders add a convenient place for any beverage.

TC3 MODELS

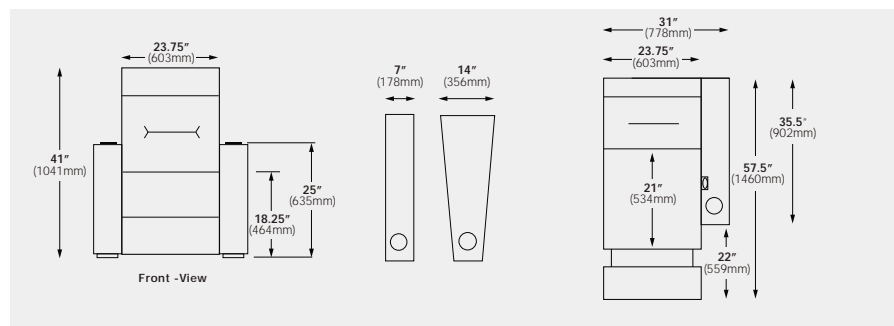
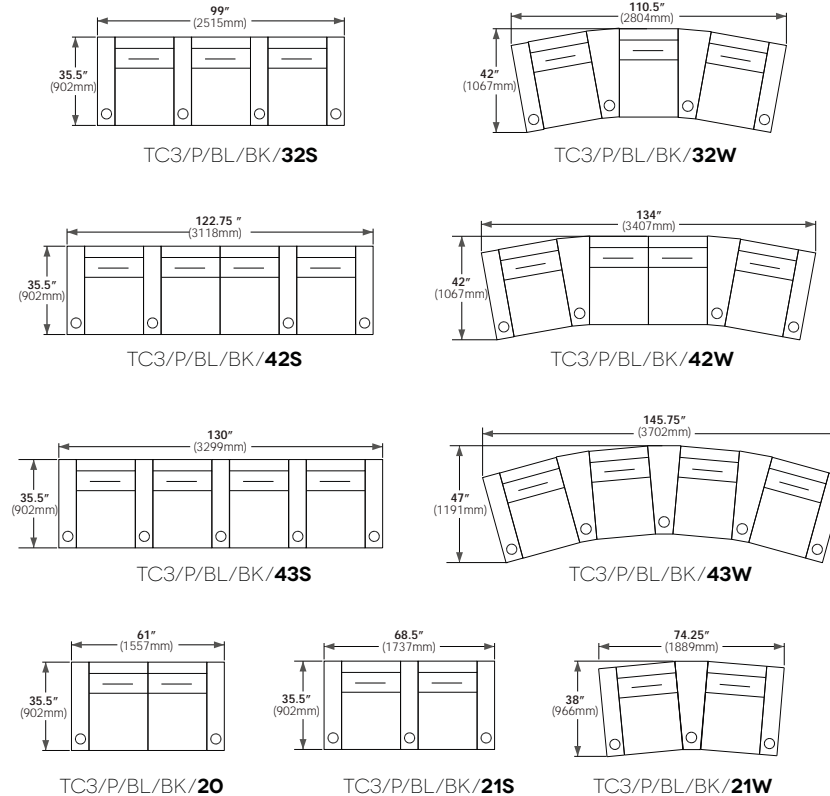

* Power Mechanism
Electrical Specifications:
110 V AC, 2.0 amps nominal
load, 5.0 amps max load,
thermally protected

MOUNTS

Salamander mounts are crafted like individual works of art, and the premium quality of their design ensures years of reliable operation.

| Description | Screen Size | | Max Weight Capacity | Universal Mounting | VESA Compliant | Distance From Wall | Tilt | | Swivel | Rotation | Mounting |
|---|-------------|-----|---------------------|----------------------------------|-------------------------------|--------------------|------|------|--------|----------|-------------|
| | min | max | | | | | up | down | | | |
| PLANO - Flat Wall Solutions | min | max | lbs | width x height | width x height | | up | down | | | |
| Plano 100 Medium | 23 | 47 | 100 | min 3.9 x 3.9 - max 16.5 x 12.1" | min 100 x 100 - max 400 x 300 | 1.2" | | | | | Single Stud |
| Plano/Flexo Combo 100 XL | 50 | 90 | 175 | min 11.8 x 11.8 - max 36 x 24" | min 300 x 300 - max 900 x 600 | 1.5" or 3.75" | 15° | 15° | | | Double Stud |
| FLEXO -Tilt Wall Solutions | min | max | lbs | width x height | width x height | | | | | | |
| Flexo 100 Medium | 23 | 47 | 100 | min 3.9 x 3.9 - max 19.7 x 12.1" | min 100 x 100 - max 500 x 300 | 2.6" | 15° | 15° | | | Single Stud |
| Flexo 100 Large | 32 | 70 | 175 | min 7.9 x 7.9 - max 35 x 20.1" | min 200 x 200 - max 800 x 500 | 3.3 | 15° | 15° | | | Double Stud |
| Flexo/Plano Combo 100 XL | 50 | 90 | 175 | min 11.8 x 11.8 - max 36 x 24" | min 300 x 300 - max 900 x 600 | 1.5" or 3.75" | 15° | 15° | | | Double Stud |
| DYNO - Articulating Wall Solutions | min | max | lbs | width x height | width x height | | | | | | |
| Dyno 102 Small* | 13 | 37 | 45 | | min 75 x 75 - max 200 x 200 | 3.5 - 18" | 15° | 15° | 180° | 360° | Single Stud |
| Dyno 102 Medium* | 23 | 50 | 100 | | min 100 x 100 - max 200 x 200 | 3.5 - 17.6" | 30° | 30° | 90° | | Single Stud |
| Dyno 102 Medium Universal Adapter | 32 | 50 | 100 | min 7.9 x 7.9 - max 31.5 x 18.7" | min 200 x 200 - max 800 x 400 | | | | | | |
| ZOOM -Desk Solutions | min | max | lbs | | width x height | height adj. | | | | | |
| Zoom 102 Dual | 13 | 24 | 33 | | min 75 x 75 - max 100 x 100 | 11 - 14.8" | 15° | 15° | 360° | 360° | Desk |
| LUNA - Ceiling Solutions | min | max | lbs | width x height | width x height | height adj. | | | | | |
| Luna 200 Projector | | | 30 | 3 or 4 hole mounting | | | 45° | 45° | | 360° | Ceiling |
| SYNCHRO - Integrated Solutions | min | max | lbs | width x height | width x height | | | | | | |
| Synchro 100 Cable Manager Small, 20" | | | | dims: 2.7"W x 19.7"H x 1.2"D | | | | | | | Single Stud |
| Synchro 100 Cable Manager Large, 41" | | | | dims: 2.7"W x 41.3"H x 1.2"D | | | | | | | Single Stud |



WALL & SPECIALTY MOUNTS



Dyno Articulating 102 Small

| | |
|----------------|------------|
| Silver | DY102/S |
| Graphite Black | DY102/S/BK |



Flexo Tilt 100 Medium

| | |
|----------------|------------|
| Silver | FX100/M |
| Graphite Black | FX100/M/BK |



Plano Fixed 100 Medium

| | |
|----------------|------------|
| Silver | PL100/M |
| Graphite Black | PL100/M/BK |



Dyno Articulating 102 Medium

| | |
|--------|---------|
| Silver | DY102/M |
|--------|---------|



Flexo Tilt 100 Large

| | |
|----------------|------------|
| Silver | FX100/L |
| Graphite Black | FX100/L/BK |



Plano Fixed / Flexo Tilt 100 X-Large

| | |
|----------------|-------------|
| Silver | FX100/XL |
| Graphite Black | FX100/XL/BK |

- Includes Both Fixed and Tilt TV Brackets



Dyno 102 Medium Universal Adapter

| | |
|-------|-----------|
| Black | MA/UA1/BK |
|-------|-----------|

- Extends Dyno 102 Medium Mounting Pattern: min 7.9 x 7.9 - max 31.5 x 18.7"
- Maximum Weight Capacity: 88 lbs.



Flexo Tilt / Plano Fixed 100 X-Large

| | |
|----------------|-------------|
| Silver | FX100/XL |
| Graphite Black | FX100/XL/BK |

- Includes Both Fixed and Tilt TV Brackets.



Luna Ceiling 200 Projector

| | |
|--------|----------|
| Silver | LU200/PJ |
|--------|----------|



Zoom Desk 102 Dual

| | |
|--------|---------|
| Silver | ZM102/D |
|--------|---------|

Hollow Wall Anchor

| | |
|----------|--------|
| Set of 2 | MA/ST2 |
| Set of 4 | MA/ST4 |

- Remedies steel stud, hollow block and other applications where conventional lag screws are not functional.



OFFICE COLLABORATION **WORKPLACE** SOLUTIONS

Businesses today operate in fluid, dynamic environments. Salamander builds furniture that defines and shapes today's office – and tomorrow's. We help create adaptable, collaborative, enduring furniture that is built to perform and to last.

MOTORIZED & FIXED HEIGHT MOBILE STANDS

Fully adjustable, electric lift, mobile stands offer convenience and flexibility with designer style. A sleek and compact design moves easily between spaces. Designed for touch screen in working, drafting, collaboration and presentation positions.

For more information on our commercial offerings,
visit: salamandercommercial.com
or email: custom@salamanderdesigns.com



Electric Lift & Tilt
Mobile Stand



Fixed Height
Mobile Stand



Electric Lift
Wall Stand



PRODUCT WARRANTIES

Salamander is proud to stand behind our products with industry-leading warranties. Should you ever encounter any problem with your Salamander product, let us know. We are here to make it right. For full warranty details see:

<http://www.salamanderdesigns.com/customerservice/warranty>

CUSTOM AV FURNITURE

Lifetime Limited Warranty

Chameleon Collection
Synergy System
Archetype System
Accessories (Non-Electronic)

ELECTRONIC ACCESSORIES

Two (2) Year Limited Warranty

AV BASICS

CABINETS - Two Year Limited Warranty

SEATING - Three (3) Year Limited Warranty on frame, springs & recline mechanism and one (1) year on all cover material.

CUSTOM SEATING

Lifetime Limited Warranty

Alex, Isabella, Matteo, Olivia, Luca, Lilliana, & Talla

- Frame / Suspension: Lifetime
- Reclining Mechanism: Lifetime Limited Warranty
- Seat Cushions: Two (2) Year Warranty
- Upholstery Fabric, Leather, Electronic and Powered Components:

TV MOUNTS

MOTORIZED - Two (2) year Limited Warranty

MANUAL - Five (5) year Limited Warranty

To receive your **Lifetime Warranty** please be sure to Register your purchase at www.salamanderdesigns.com/customerservice/warrantyform.





TRADE PROGRAM

All qualified interior designers, decorators and architects are invited to join the Salamander's Trade Program. As a member, you'll have access to special sales, promotions, and discounts that fit the needs of your unique project. Our highly customizable collections of furniture and seating will help you create innovative furniture concepts that satisfy business needs, delighting customers and clients

Dealer/Designer Program Benefits

- Trade Discounts
- White Glove delivery options available
- Access to Salamander Factory Design Consultants
- Granted full Showroom Access
- Delivery & Installation Services
- Designer Resources
- Build-To-Order and Quick-Ship-Capability

Contact your Salamander Sales Rep for more details.

www.salamanderdesigns.com/designers



Visit SalamanderDesigns.com
for the latest products and discover
which material will look best in your
home by requesting swatches.



Salamander Designs Ltd.

For Sales Inquiries:
800.535.9910 or 860.761.9500
sales@salamanderdesigns.com

