



---

**GUIDE FOR USING THE DISHWASHER AND THE WASHING PROGRAMS**

---



**Contents**

**1 INTRODUCTION.....3**

**2 DESCRIPTION OF THE CONTROLS.....5**

2.1 Upper panel .....5

2.2 Setting the washing program and switching on and off.....6

2.2.1 Switching on .....8

2.2.2 Selecting and starting the program ..... 9

2.2.3 End of program ..... 9

2.2.4 Interrupting a program ..... 9

2.2.5 Changing the current program ..... 9

2.2.6 Canceling the current program .....10

2.2.7 Switching off .....11

2.2.8 Removing the dishes ..... 11

**3 ENERGY SAVING AND ENVIRONMENTAL RESPECT ..... 12**

3.1 Reducing the consumption of detergent and respecting the environment.. 12

**4 TROUBLESHOOTING ..... 13**

**5 OPERATING INSTRUCTIONS ..... 15**

5.1 Using the water softening system (on some models only) ..... 15

5.2 Using the rinse-aid and detergent dispenser ..... 17

5.2.1 Adding the rinse-aid ..... 18

5.2.2 Adjusting the rinse-aid dispenser setting ..... 18

5.2.3 Adding the detergent..... 19

5.3 General warnings and recommendations ..... 21

5.4 Using the racks..... 23

5.4.1 Lower rack..... 24

5.4.2 Cutlery basket..... 26

5.4.3 Upper rack ..... 27

**6 CLEANING AND USER MAINTENANCE ..... 30**

6.1 General warnings and recommendations ..... 30

6.2 Cleaning the water intake filter..... 31

6.3 Cleaning the spray arms ..... 31

6.4 Cleaning the filter unit ..... 33

6.5 General warnings and recommendations for correct maintenance ... 34

6.6 Troubleshooting minor problems..... 35

**7 IMPORTANT SAFETY AND INSTRUCTIONS ..... 37**

**8 INSTALLATION AND HOOK-UP..... 43**

**9 TECHNICAL DATA..... 45**



## 1

**INTRODUCTION**

*Thank you for choosing one of our products. To use this dishwasher correctly and safely, please read this manual carefully. The manual is divided into sections giving you a step-by-step guide to all your appliance's functions.*

*The texts are easy to understand and are complete with detailed illustrations. Following the cleaning instructions provided here will keep dishwasher performance at peak levels in the long term. This user-friendly manual will provide answers to all your questions about use of the dishwasher.*

**This manual comprises the following sections:**

*INTRODUCTION: general information about the manual.*

*USER INSTRUCTIONS: advice on using the washing programs and information about all the dishwasher functions.*

*Useful advice is provided for the use of racks, spray arms, containers and filters.*



*WARNINGS: a list of warnings concerning safety and use of the dishwasher.*

*INSTALLATION INSTRUCTIONS: for the **qualified technician** who must carry out the installation, hook-up and testing of the appliance.*

**Nomenclature of figures and tables:**

*The progressive number of each figure is shown in the bottom right-hand corner of the relative box. An example of a progressive number is "Fig. 4-01", where the first number (4) indicates the section to which the figure belongs, while the second number (01) indicates the progressive number of the figure in section 4 (Fig. 4-01 is the first figure in section 4). The tables are numbered in the same way, bearing in mind that "Tab." is used instead of "Fig." (e.g.: Tab. 4-01 is the first table in section 4). If a table occupies more than one page, a letter is added after the progressive number (e.g.: "Tab. 4-01a", Tab. 4-01b").*

**Symbols used in this manual** (see tab. 1-01)

	<b>DANGER.</b> This symbol highlights information and warnings which, if not observed, may compromise personal safety or damage the appliance.
	<b>DANGER OF ELECTROCUTION.</b> This symbol highlights information and warnings of an electrical nature which, if not observed, may compromise personal safety or damage the appliance.
	This symbol highlights general information and warnings.
Tab. 1-01	

## 2 DESCRIPTION OF THE CONTROLS

### 2.1 Upper panel

All the dishwasher controls are grouped on the upper panel (see fig. 2-01). The dishwasher can only be switched on, programmed, switched off, etc. with the door open.

A brief description (see tab. 2-01) of the various controls on the upper panel is given below.



FIG. 2-01

The panel shown is indicative, programs and options may vary depending on model.

1	<b>On/off button</b> Press to power the appliance.
2	<b>Program indicator lights</b> These show which program is selected and whether there are any faults (Troubleshooting).
3	<b>Program selection button</b> Press in sequence to select the required program..
4	<b>Add salt indicator light (only fitted on some models)</b> Shows the appliance has run out salt. <b>WATER HARDNESS ADJUSTMENT ON INDICATOR LIGHT</b> The light flashes to indicate that the appliance is in "water hardness adjustment" mode.
5	<b>Add rinse aid indicator light</b> (only fitted on some models) Shows the appliance has run out of rinse aid..
6	<b>Quick time option button</b> Press this button to start one of the quick time programmes (see table).
7	<b>Quick time programmes indicator light</b> Shows that one of the quick time programmes will be run
8	<b>Delayed Start Button</b> Pressing this button delays the start of the program by 3, 6 or 9 hours.
9	<b>Delayed Start Lights</b> Illuminate to show that start delayed by 3, 6 or 9 hours has been set. <b>Sanitisation confirmation lights</b> If the three lights illuminate simultaneously at the end of the wash cycle, sanitisation has been completed
Tab. 2-01	

## 2.2 Setting the washing program and switching on and off

The dishwasher is equipped with a control panel (see fig. 2-02) which is used to program the appliance and switch it on and off.

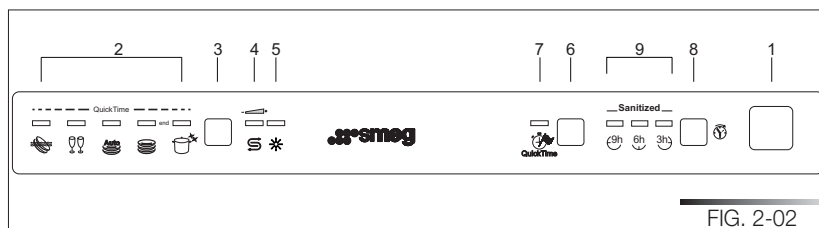













FIG. 2-02



To select the most suitable program for the dishes to wash, consult the following table which specifies the most appropriate type of washing sequence depending on the kind of dishes and how dirty they are (see tabs. 2-02a and 2-02b)

PROGRAMME, NUMBER & SYMBOL		LOAD CROCKERY AND CUTLERY	PROGRAM PROGRESS	DURATION	CONSUMPTION		
				MINUTES (1)	WATER	ENERGY KWH (1)	
1		SOAK	Pans and dishes awaiting completion of the load.	Cold prewash	15	4.0l 1.06gal.	0.02
2		CRYSTAL	Glass, china and mixed dishes with light dirt.	Wash at 45°C (113°F) Cold rinse Rinse at 70°C (158°F) Dry	75	10l 2.64gal.	0.95
3	 <b>Auto</b>	AUTO DELICATE (2)	Dishes washed immediately after use.	Wash at 45°C (113°F) Cold rinse Rinse at 65°C (149°F) Dry	115-135	10.2l 2.7 gal.	0.6-0.8
4		DAILY WASH	Dishes with normal dirt, including dried-on residues.	Cold prewash Wash at 65°C (149°F) Cold rinse Rinse at 70°C (158°F) Dry	120	13l 3.43 gal.	1.20
5		EXTREME WASH ETL SANITATION LISTED	Dishes with normal dirt, including dried-on residues.	Hot prewash Wash at 70°C (158°F) Cold rinse Rinse at 70°C (158°F) Dry	140	17.5l 4.62gal.	1.2
6	 +  QuickTime	RAPID 27'	Dishes with light dirt, washed immediately after use.	Wash at 38°C (100°F) Rinse at 50°C (122°F)	27	7l 1.84gal.	0.4
7	 +  QuickTime	DELICATE QUICK	Dishes with light dirt.	Cold prewash Wash at 50°C (122°F) Cold rinse Rinse at 70°C (158°F)	60	13l 3.43gal.	1.0

PROGRAMME, NUMBER & SYMBOL		LOAD CROCKERY AND CUTLERY	PROGRAM PROGRESS	DURATION	CONSUMPTION		
				MINUTES (1)	WATER	ENERGY KWH (1)	
8	 Auto + QuickTime	ECO QUICK	Dishes with normal dirt, washed immediately after use.	Cold prewash Wash at 60°C (140°F) Cold rinse Rinse at 70°C (158°F)	85	13l 3.43gal.	1.2
9	 + QuickTime	NORMAL QUICK	Dishes with normal dirt, washed immediately after use.	Cold prewash Wash at 65°C (149°F) Cold rinse Rinse at 70°C (158°F)	90	13l 3.43gal.	1.3
10	 + QuickTime	STRONG and FAST	Mixed dishes with normal dirt without dried-on residues.	Wash at 65°C (149°F) Cold rinse Rinse at 70°C	55	10l 2.64gal.	1.12

Tab. 2-02

- (1) The cycle times and electrical energy listed use and care manual are based on normal soil loads and 120°F (49°C) incoming water and will vary based on your actual conditions.
- (2) Program for energy star.
- Only "EXTREME WASH" program conforms to NSF std 184 and is certified by INTERTEK with the ETL SANITATION LISTED.
  - If the three lights illuminate simultaneously at the end of the wash cycle, the dishwasher's contents and the dishwasher itself have been sanitised in compliance with National Sanitisation Foundation (NFS) requirements.

**Only** run the soak program with half loads.

After using the above tables to choose the most suitable washing cycle, program the appliance.



*Before starting a washing program, make sure that:*

- The water supply tap is **open**.
- **The correct amount of detergent** has been added to the **dispenser** (to add detergent, see the instructions in the general manual).
- The spray arms are able to rotate **freely** and without obstruction.
- The racks have been **correctly loaded** (see the instructions in the general manual).
- The dishwasher door **is securely closed**.

## 2.2.1 Switching on

Press the on/off button (ref. 1 fig. 2-02) to start the dishwasher. Then wait for one of the **program indicator lights** to turn on (ref. 2 fig. 2-02).

## 2.2.2 Selecting and starting the program

- Press the **program selection button** (ref. 3 fig. 2-02) several times until the indicator light corresponding to the required program turns on (ref. 2 fig. 2-02);
- if required, press the relative buttons to select any complementary functions (e.g.: “extra drying”, “program delay”; see para 2.2.7 “options”);
- close the door; the program will start after about **2 seconds** and the relative indicator light will flash throughout the cycle (program→ running signal).

### IMPORTANT

The door of the dishwasher must be **closed within 4 seconds after use of the program selection button** for all functions (e.g. program selection, change, deletion, etc.).

If the door is not closed within 4 seconds, **one or more program lights** (depending on the current operation) **will flash at high speed** to indicate that **the operation must be confirmed** before the door is closed.



To **confirm, simply press the program selection button once** and the flashes will slow down; close the door at once to start/restart the dishwasher.

The same applies if the dishwasher is opened **with the program delay option set and the cycle not started** (e.g. to add more dishes): **the program selection button must be pressed before the door is closed**, restarting the program delay countdown.

If the door of the dishwasher has not been closed or has been incorrectly closed, the washing cycle will not begin.

### FAST CYCLES OPTION

- Select this option together with any washing program (except the soak program) to **SHORTEN** the cycle by from a minimum of 10% to a maximum of 55%, depending on the cycle selected. To activate this option, press the **FAST CYCLES** button  (light comes on) after selecting the program required. The option is automatically deactivated at the end of the program.

## 2.2.3 End of program

The end of the program is signaled by a short beep. Additionally the indicator light of the normal and strong programs (marked “end”) flash.

## 2.2.4 Interrupting a program

To interrupt the current program simply open the door of the dishwasher; to restart the program, simply close the door again. The program restarts from where it was interrupted.

## 2.2.5 Changing the current program

To change the current program, simply open the door of the dishwasher and select the new program. Close the door to run the new program automatically.

### 2.2.6 Canceling the current program

- To cancel the current program, open the door and press and hold down the **program selection** button (ref. 3 fig. 2-02) for a few seconds until the indicator lights of the fourth and fifth programs turn on (ref. pr. 4, pr. 5 fig. 2-03).
- Close the door again.
- After about 1 minute, the dishwasher terminates the cycle and the indicator lights of the fourth and fifth programs (ref. pr. 4, pr. 5 fig. 2-03) start flashing.

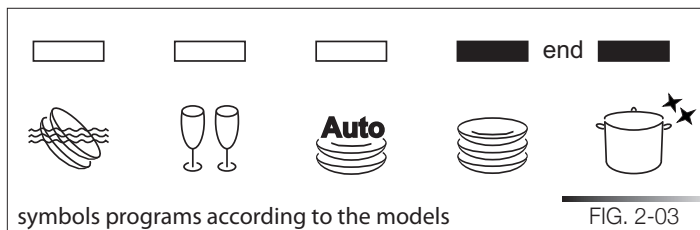

## 2.2.7 Switching off

At the end of the program, the dishwasher emits a short beep and the **indicator lights of the fourth and fifth program** (ref. pr. 4, pr. 5 fig. 2-04) flash. Turn off the appliance by opening the door and pressing the **on/off button** (ref. 1 fig. 2-02).

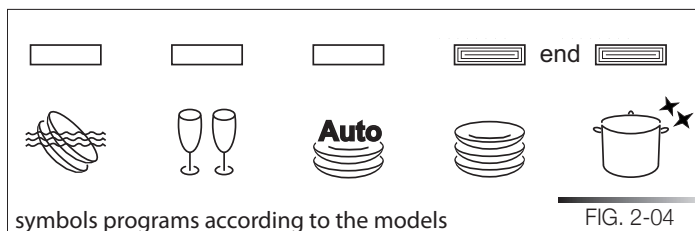

*If it is necessary to open the door during the washing cycle, the program will be interrupted, the relative indicator light will continue to flash and a beep will indicate that the cycle has not terminated. Wait for about **1 minute** before closing the door and continuing with the program. When the door closes, the program will start from where it was interrupted. This operation should be performed **only if necessary** as it could cause irregular program performance.*

## 2.2.8 REMOVING THE DISHES



*At the end of the washing program, wait at least **20 minute** before removing the dishes in order to allow them to cool. To prevent any water droplets on the upper rack from falling onto the dishes in the lower rack, **empty the lower rack** first and then the upper one.*

### 3 **ENERGY SAVING AND ENVIRONMENTAL RESPECT**

- **Always** try to run the dishwasher **fully loaded**.
- Do not wash the dishes under a running tap.
- Use the **most suitable** washing program for each type of load.
- Do not pre-rinse.
- If available, connect the dishwasher to a hot water system with a temperature of up to 60°C (140°F).
- When possible, **skip the drying cycle** by opening the door after washing: the air and the residue heat will dry the dishes to perfection.

#### 3.1 **Reducing the consumption of detergent and respecting the environment**

The phosphates contained in dishwasher detergents are harmful to the environment. To avoid using excessive amounts of detergent and to save on electricity:





































































































- **Separate** the more delicate items from those that are more resistant to aggressive detergents and high temperatures;
- **Do not pour** the detergent directly onto the dishes.

## 4 TROUBLESHOOTING



The dishwasher can signal a number of malfunctions by turning on various indicator lights, as described below (see following table):

	FAULT	DESCRIPTION
E1		<p><b>Acquastop failure</b> The anti-flooding system has tripped (only for models fitted with this feature). Activates in case of water leaks. Contact the technical assistance service.</p>
E2		<p><b>Safety level</b> The system limiting the water level in the dishwasher has tripped. Interrupt the current program. Switch off the dishwasher, switch it back on again, program a new cycle and press start. If the problem persists, contact the technical assistance service.</p>
E3		<p><b>Water heating malfunction</b> The water is not heated or is incorrectly heated. Repeat the washing program; if the problem persists, contact the technical assistance service.</p>
E4		<p><b>Water temperature monitoring malfunction</b> Interrupt the current program. Switch off the dishwasher, switch it back on again, program a new cycle and press start. If the problem persists, contact the technical assistance service.</p>
E5		<p><b>Water intake malfunction</b> The appliance does not take in water or does so incorrectly. Make sure the water connections are correct, that the water supply tap is open and that the filter is not clogged. If the problem persists, contact the technical assistance service.</p>

Tab. 4-01a

FAULT		DESCRIPTION
E6	                   	<p><b>Water pump-out malfunction</b></p> <p>The appliance does not pump out the water or does so incorrectly. Make sure the drain hose is not kinked or crushed and that the siphon and filters are not clogged. If the problem persists, contact the technical assistance service.</p>
E7	                   	<p><b>Turbine flow-regulator malfunction</b> (only for models fitted with this feature)</p> <p>The appliance is unable to precisely measure the quantity of incoming water. Interrupt the current program and switch off the dishwasher. Switch it back on again, program a new cycle and press start. If the problem persists, contact the technical assistance service.</p>
E8	                   	<p><b>Alternate washing system malfunction</b></p> <p>Interrupt the current program and switch off the dishwasher. Switch it back on again, program a new cycle and press start. If the problem persists, contact the technical assistance service.</p>
E9	                   	<p><b>Water intake system malfunction</b></p> <p>Contact the technical assistance service.</p>
E11	                   	<p><b>Wash motor pump does not work</b></p>

Tab. 4-01b

 Light off
  Light on
  Light flashing

If an alarm situation occurs, the dishwasher interrupts the current program and signals the fault.

- Alarms **E1, E2, E3, E4, E8, E9** immediately terminate the current program.
- Alarms **E5, E6** interrupt the current program and, after the problem has been eliminated, resume the cycle.
- Alarm **E7** is displayed at the end of the cycle which, however, is completed given that it does not jeopardize the operation of the dishwasher.
- **E11: Contact the after-sales service.**

To “reset” an alarm:

- open or close the door, or switch the appliance on and back off again. At this point, the dishwasher can be programmed again.



*If the fault persists, contact the Authorized Technical Assistance Service.*



## 5 OPERATING INSTRUCTIONS



*BEFORE STARTING TO USE THE APPLIANCE, MAKE SURE YOU HAVE READ AND UNDERSTOOD ALL THE WARNINGS CONTAINED IN CHAPTER 2 "IMPORTANT SAFETY INSTRUCTION".*

Once the dishwasher has been correctly installed, prepare for use as follows:

- adjust the water softening system;
- add the regenerating salt;
- add the rinse-aid and detergent.

### 5.1 Using the water softening system

The amount of scale contained in the water (water hardness index) can cause whitish staining on the dry dishes, which tend to become dull over time. The dishwasher is equipped with an automatic softening system which uses a special regenerating salt to reduce the hardness of the water. The dishwasher is factory set for water hardness level 3 (average hardness **41-60°dF – 24-31°dH / 23.6-35 gpg**). When using water of medium hardness, the regenerating salt container should be refilled after approximately 20 washing cycles. The salt container can hold approximately **1.5 Kg (3.3 lb)** of salt in grains. Some models are equipped with an optical no-salt indicator. In these models, the cap of the salt container contains a green float which descends as the salt concentration in the water drops. When the green float can no longer be seen, the container must be topped up with regenerating salt. The container is situated at the bottom of the dishwasher. After removing the lower rack, unscrew the salt container cap by turning it anticlockwise and pour in the salt using the funnel supplied with the dishwasher. Before re-placing the cap, remove any salt residues from around the opening.

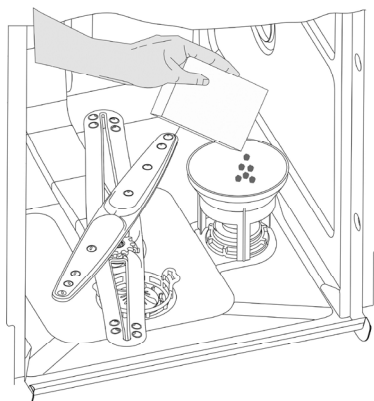

- When using the dishwasher for the first time, in addition to the salt it is also necessary to add **one liter of water** to the container.
- Each time the salt container is refilled, make sure **that the cap (ref. A fig. 5-01) is securely closed**. The mixture of water and detergent must never penetrate the salt container, as this would compromise the operation of the regeneration system. In the event of this occurring, the warranty will be invalidated.
- Only use regenerating salt specially formulated for domestic dishwashers. If using salt tablets, **do not fill the container completely**.
- **Do not use table salt** as it contains insoluble substances which, over time, may damage the water softening system.
- When necessary, refill the regenerating salt container **before starting the washing program**. In this way, the excess saline solution will be immediately removed by the water; the prolonged presence of salt water inside the tank may lead to corrosion.



**BE CAREFUL NOT TO CONFUSE THE SALT AND DETERGENT PACKAGES; ADDING DETERGENT TO THE SALT CONTAINER WILL DAMAGE THE WATER SOFTENING SYSTEM.**

## 5.2 Using the rinse-aid and detergent dispensers

The detergent and rinse aid dispensers are situated on the inner part of the door: **the detergent dispenser** (ref. A fig. 5-03) is on the left, and the **rinse-aid dispenser** (ref. B fig. 5-03) is on the right.

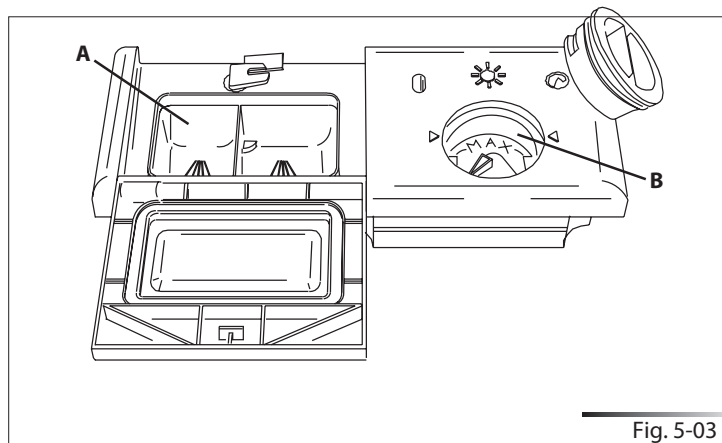

WITH THE EXCEPTION OF THE **SOAK** PROGRAM, BEFORE EVERY WASHING CYCLE IT IS NECESSARY TO ADD THE REQUIRED AMOUNT OF DETERGENT TO THE **DETERGENT DISPENSER**. THE RINSE AID, ON THE OTHER HAND, SHOULD ONLY BE ADDED AS REQUIRED.

### 5.2.1 Adding the rinse-aid

The rinse aid helps the dishes dry faster and prevents the formation of scale deposits and staining; it is automatically added to the water during the final rinse cycle, from the container situated on the inner side of the door.

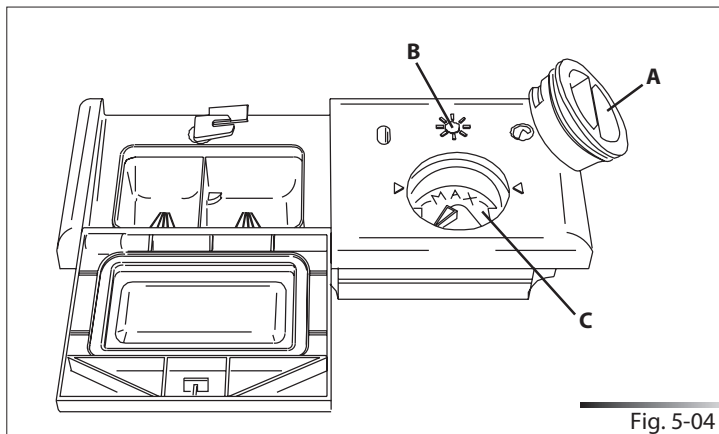

Fig. 5-04

To add rinse aid:

- Open the door.
- Rotate the container cover (ref. A fig. 5-04) anticlockwise by  $\frac{1}{4}$  of a turn and remove it.
- Add the rinse aid until the container is full (approximately 140 ml). The optical level indicator (ref. B fig. 5-04), on the side of the cap should be completely obscured. Refill the rinse aid when the optical level indicator becomes clear again, or when the rinse aid warning light illuminates (see "Description of controls" manual).
- Replace the cover (ref. A fig. 5-04) by turning it in a clockwise direction until it is fully closed.
- Use a cloth to remove any spillage of rinse aid which might lead to the formation of excess foam.

### 5.2.2 Adjusting the rinse-aid dispenser setting

The rinse-aid dispenser can be set to one of 6 different levels. The dishwasher is factory set for medium water hardness (selector set to "3"). To change the setting, turn the dispenser selector (ref. c fig. 5-04) to the desired position: the amount of rinse-aid dispensed is proportional to the position of this selector. Make sure that the minimum amount of rinse-aid (selector turned to "1") is approximately 1 ml and the maximum amount (selector turned to "6") is approximately 6 ml.

- To adjust the rinse aid setting, rotate the dispenser cover (ref. A fig. 5-04) through a quarter turn in an anticlockwise direction and remove it.
- Then use a screwdriver to rotate the rinse aid selector to the desired position.
- Replace the cover (ref. A fig. 5-04) by turning it in a clockwise direction until it is fully closed.
- The amount of rinse aid must be increased if the washed dishes appear dull or feature circular stains.
- If, on the other hand, the dishes are sticky or have white streaks, it is necessary to reduce the rinse aid setting.

## 5.2.3 Adding the detergent



*DO NOT INHALE OR SWALLOW DETERGENT AS THIS MAY CAUSE BURNS AND/OR PERMANENT DAMAGE TO THE NOSE, MOUTH AND THROAT, AND EVEN LEADING TO SUFFOCATION; KEEP DETERGENT AWAY FROM YOUR EYES. IF ONE OF THE ABOVE SITUATIONS OCCURS, SEEK MEDICAL ASSISTANCE IMMEDIATELY.*

*PREVENT CHILDREN FROM COMING INTO CONTACT WITH DETERGENT;*

*KEEP THEM AWAY FROM THE DISHWASHER WHEN THE DOOR IS OPEN AS IT MAY CONTAIN DETERGENT RESIDUES. FILL THE DISHWASHER JUST BEFORE STARTING THE WASHING CYCLE AND THEN KEEP THE DETERGENT OUT OF THE REACH OF CHILDREN.*

To open the detergent dispenser cover, lightly press the relative button (ref. A fig. 5-05). Add the detergent and close the cover carefully, pushing down on the arrow (ref. B fig. 5-05). During the washing cycle, the dispenser will be opened automatically.

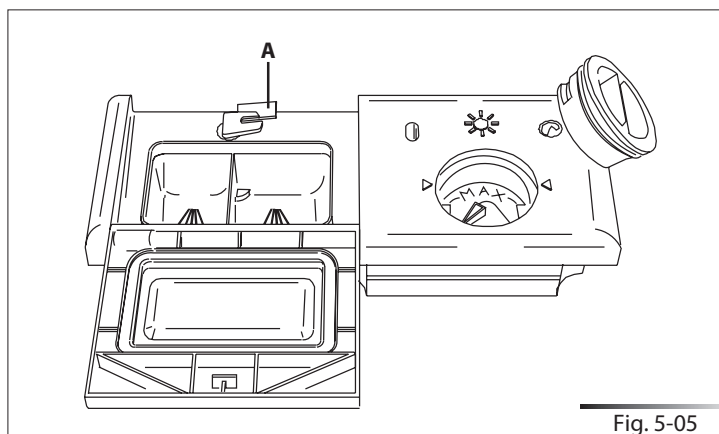
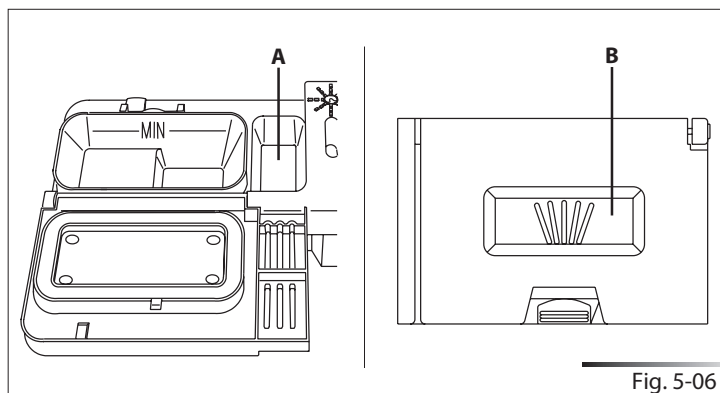

Fig. 5-05



- When a program with hot prewash is selected (see program table in the “Description of Controls” manual), extra detergent must be placed in the cavity (ref. A or B fig. 5-06, depending on models).
- **Only** use dishwasher-specific detergents. For optimal washing results it is important to use a good quality detergent.
- The detergent packs must be sealed and stored in a dry place to prevent the formation of lumps which may negatively affect washing results. Once opened the detergent packs should not be kept for too long, otherwise the detergent loses its effectiveness.
- Do not use detergents formulated for washing dishes by hand, because they produce a great deal of foam and may negatively affect the operation of the dishwasher.
- Add the correct amount of detergent. An insufficient amount of detergent will result in a partial removal of dirt from the dishes, whereas an excessive amount is wasteful and does not improve the washing results.
- The market offers liquid and powder detergents with differing chemical compositions, which may contain **phosphates**, or be phosphate-free but contain **natural enzymes**.
- Detergents containing **phosphates** are more effective against grease and starch at **temperatures above 60°C (140°F)**.
- Enzyme detergents, on the other hand, are also effective at lower temperatures (**from 40 to 55°C / from 104 to 131°F**) and are more easily biodegradable. With enzyme detergents it is possible to obtain at low temperatures comparable results to those which can only be achieved at **65°C (149°F)** using traditional detergents. For the safeguarding of the environment we recommend the use of **phosphate- and chlorine-free** detergents.

- When using detergent tabs, place them in the cutlery basket. The dispenser has been designed for powder or liquid detergent. As the cover does not open completely during the washing cycle, tabs are not fully released (dissolved). This could generate the following problems:
  - insufficient detergent released during the cycle and poor washing results;
  - the detergent is compacted in the dispenser and is released during the final rinse cycle.



*THE INTRODUCTION OF DETERGENT INTO THE RINSE AID DISPENSER, EVEN IN LIQUID FORM, WILL DAMAGE THE DISHWASHER.*

## 5.3 General warnings and recommendations

Before using the dishwasher for the first time, it is advisable to read the following recommendations concerning dish types to be washed and their loading. There are generally no constraints on the washing of domestic dishes, but in certain cases it is necessary to take their characteristics into account. Before loading the dishes into the racks it is necessary to:

- remove coarse food remains: e.g. bones, fish-bones, etc. which may clog the filter or damage the wash pump;
- soak any pots or pans with burnt-on food remains on the bottom to facilitate removal, then load them into the LOWER RACK.

Use the “**½ load wash**” option (if available) for washing small amounts of dishes; it saves water and electricity. When using this function, **only load the rack selected for the ½ load wash**; the other rack must remain empty. There is no need to pre-wash the dishes under running water before loading them into the racks since this only wastes water. **Correct loading of the dishes helps ensure optimal washing results.**

### WARNING!

- make sure that the dishes are securely in place so that they cannot tip over or obstruct the rotation of the spray arms during the washing cycle;
- do not place very small objects in the racks as these could fall and obstruct the spray arms or the wash pump;
- containers such as cups, bowls, glasses and pots should always be loaded with the opening facing downwards and with any cavities at an angle, to allow the water to drain out;
- do not stack dishes or place them in such a way that they cover one other;
- do not place glasses too close together because they may knock against each other and break, or there might be staining at the point where they touch.

**MAKE SURE that the items being washed are dishwasher-safe.**

**Items which are not dishwasher-safe:**

- **Wooden dishes, pots or pans:** these may be damaged by the high washing temperatures.
- **Handcrafted items:** these are rarely suitable for washing in a dishwasher. The relatively high water temperatures and the detergents used may damage them.
- **Lightweight objects:** place lightweight objects in the upper rack where the water pressure is lower.
- **Dishes and objects in copper, tin, zinc or brass:** these tend to stain.
- **Aluminum dishes:** items made from anodized aluminum may lose their color.
- **Silverware:** silver items may stain.
- **Glass and crystal:** in general, glass and crystal objects can be washed in the dishwasher. However, certain types of glass and crystal may become dull and lose their clearness after many washings. Therefore, for these items we recommend using the least aggressive program available (see "Description of controls" manual).
- **Decorated items:** the decorated objects available on the market are generally able to withstand washing in the dishwasher, although the colors may fade after a great many washes. If in doubt as to the fastness of the colors, it is advisable to wash just a few items at a time for approximately one month.



## 5.4 Using the racks

The dishwasher has a capacity of **10 place-settings**, including serving dishes. Examples of loading 10 place-settings in the upper rack (see fig. 5-07) and in the lower rack (see fig. 5-08) are shown below; move the upper rack to its bottom position when loading in this way.

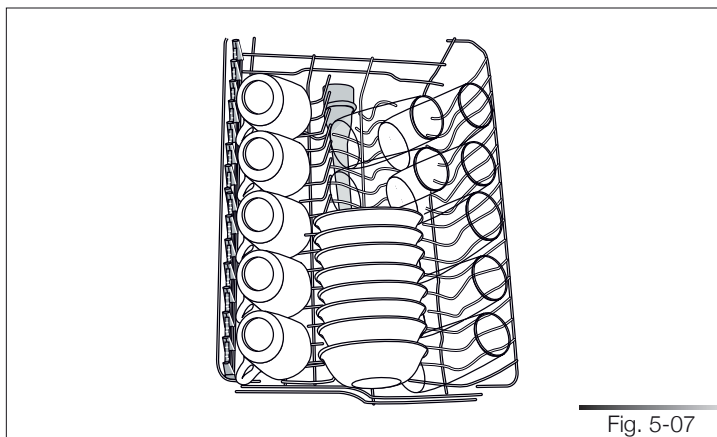

Fig. 5-07

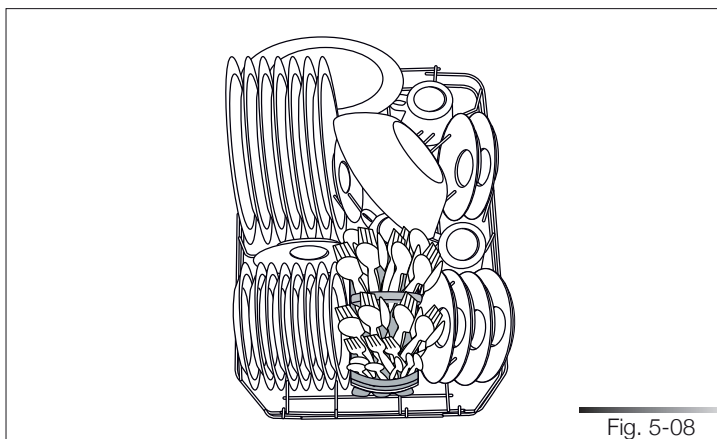

Fig. 5-08

### 5.4.1 Lower rack

The lower rack receives the full force of the lower spray arm, and should therefore be used for the “toughest” items with a heavier degree of soiling.

All types and combinations of loads are permitted, provided that the dishes, pots and pans are arranged with all the soiled surfaces exposed to the water jets coming from the bottom.

To make the most of the space inside the rack when loading large items, certain models are equipped with tip-up supports for plates in 2 or 4 sections (see fig. 5-09).

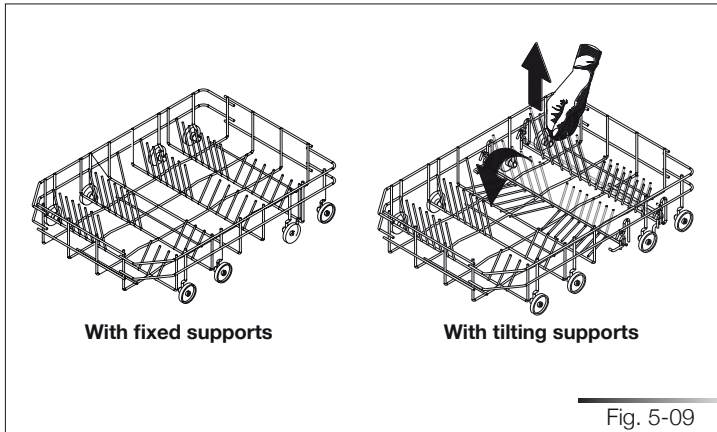

## ***Loading the lower rack*** (see fig. 5-10)

Carefully load flat plates, soup plates, dessert and serving dishes, positioning them vertically. Pots, pans and their covers must be loaded upside down. When loading soup plates and dessert bowls, be sure to leave a gap between them.

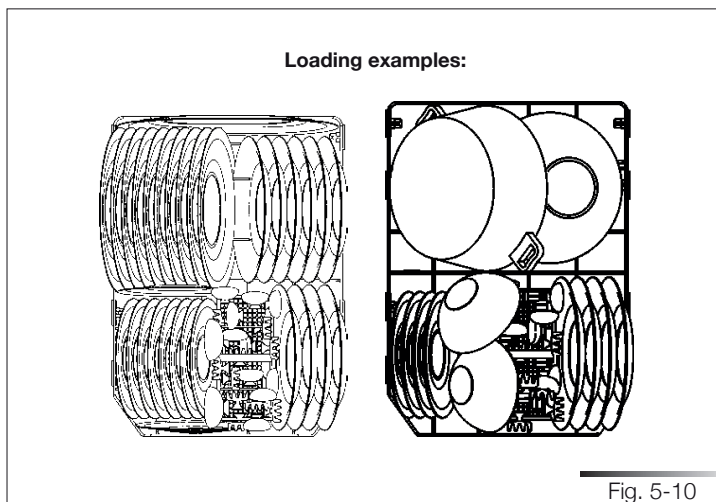

### 5.4.2 Cutlery basket (see fig. 5-11)

The cutlery basket can be removed to simplify unloading.

Arrange the cutlery in an orderly manner inside the basket, **with the handles pointing downwards and taking care not to injure yourself with the knife blades.** The basket is suitable for all types of cutlery, except those long enough to interfere with the upper spray arm.

Place **long items** (ladles, wooden spoons and cooking knives) that may interfere with the spray arm in the **upper rack making sure that knife tips do not protrude.**

The dishwasher is complete with two cutlery baskets, which means that one of them can be removed, freeing space in the bottom rack, if there is not much cutlery to be washed.

The baskets feature an exclusive system of independent sliding tip-up supports, offering a choice of combinations to allow optimum use of the space available.

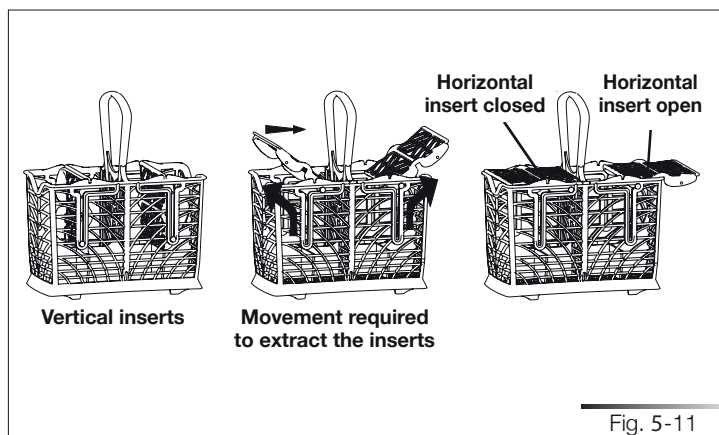

## 5.4.3 Upper rack (vedi fig. 5-12, 5-13)

It is recommended to load the upper rack with small- or medium-sized items such as glasses, small plates, tea or coffee cups, shallow bowls and light objects made from heat resistant plastic.

If the upper rack is used in the lowermost position, it can also be loaded with serving dishes, provided they are only slightly soiled.

The two tip-up “cutlery baskets” on the right-hand side of the rack can be opened or closed as required (see fig. 5-12). The two cup supports on the left-hand side of the rack can be opened or closed as required (see fig. 5.13).

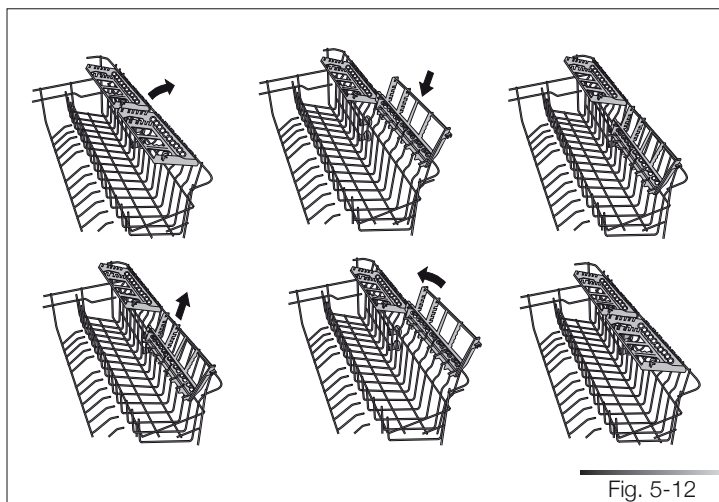

Fig. 5-12

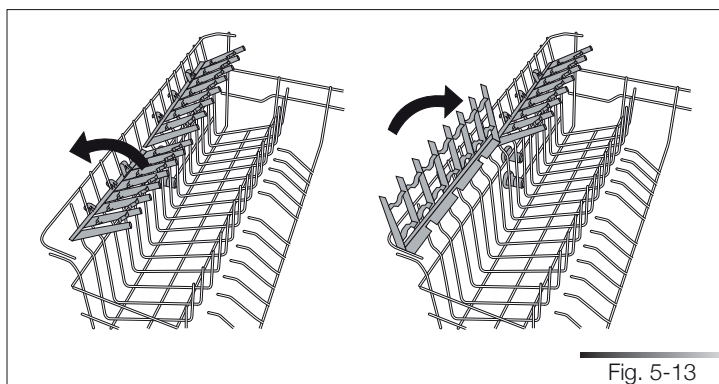
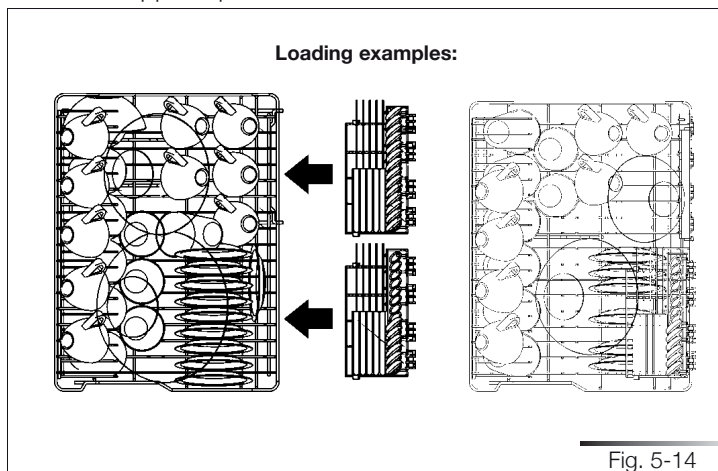

Fig. 5-13

### **Loading the upper rack** (vedi fig. 5-14)

Load plates facing forward; cups, bowls etc. must always be facing downwards. The left-hand side of the rack can be loaded with two layers of cups and glasses. The right-hand side can be filled with plates and side-plates, fitted upright into the supports provided.



### **ADJUSTING THE UPPER BASKET**

The height of the upper basket can be according to requirements and the size of the dishes in the lower basket.

Pull-out adjustment system:

- Turn the retainer **E** on both runners, right and left, through **90°**
- Remove the basket
- Lift the basket and fit the smaller pairs of wheels in the runners
- Return the retainers **E** to their original position

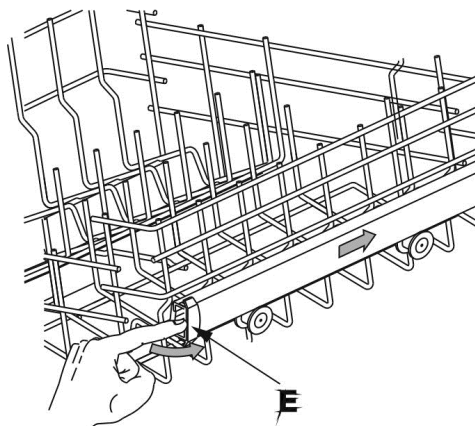

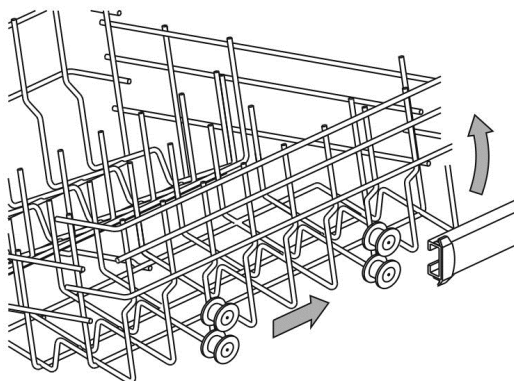

### Quicklift position setting system:

system with **3 position settings** (1 lowest, 3 highest). The basket is snapped into the position required, lifting both sides **simultaneously**. To return to the lowest position from any height, lift the basket to the **highest position and then release**.

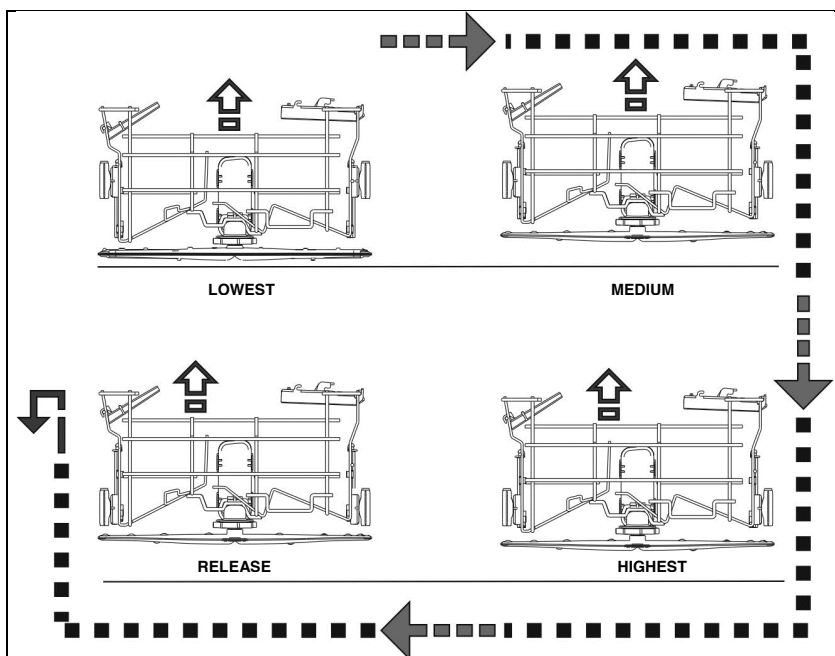

## 6 **CLEANING AND USER-MAINTENANCE**



***BEFORE CARRYING OUT ANY WORK, ALWAYS DISCONNECT THE APPLIANCE FROM THE ELECTRICAL POWER SUPPLY.***

### 6.1 **General warnings and recommendations**



***NEVER USE ABRASIVE AND/OR CORROSIVE DETERGENTS TO CLEAN THE APPLIANCE.***

Clean the outer surfaces and door-lining of the dishwasher regularly using a soft cloth moistened with a neutral detergent (not abrasive and/or corrosive) suitable for painted surfaces. Clean the door gaskets with a damp sponge. Periodically (once or twice a year) it is advisable to clean the tank and gaskets, using a soft cloth and water to remove any deposits.

Do not clean the controls with too much water as this may leak onto the electronic components and damage them.

After cleaning, dry the appliance with a soft, lint-free cloth.

If stainless steel surfaces are preset, clean them with a non-abrasive product specific for stainless steel. To prevent stains, a nebulizer may also be used, though sparingly and at a moderate pressure.



## 6.2 *Cleaning the water intake filter*

Clean the water inlet filter at regular intervals. After closing the delivery tap, unscrew the ring nut (ref. A fig. 6-01) on the water inlet pipe (using a pair of pliers, if necessary) and delicately clean the filter, removing deposits or impurities.

Then firmly fix the pipe by tightening the ring nut (ref. A fig. 6-01) (use a pair of pliers, if necessary).

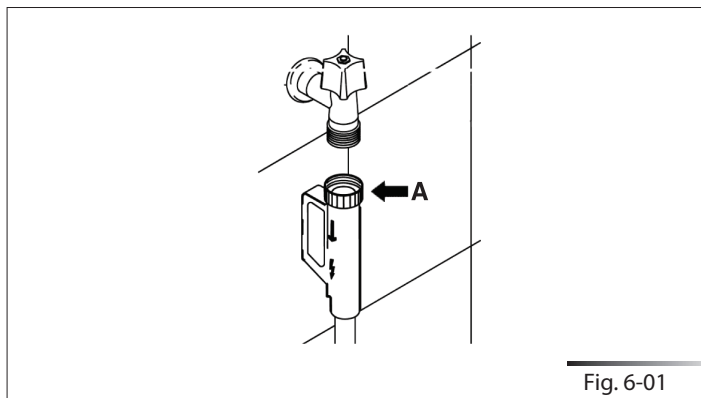

## 6.3 *Cleaning the spray arms*

The spray arms can be easily removed for periodic cleaning of the nozzles, to prevent possible clogging. Wash them under running water (at room temperature) and carefully replace them in their seats, **checking that their rotary movement is in no way impeded**; if this is not the case, make sure they have been mounted properly.

### **Removing the spray arms**

- To remove the **upper** spray arm (ref. A fig. 6-02), unscrew the locking ring (ref. R fig. 6-02) by turning it clockwise. After cleaning, remount the spray arm in its seat and tighten the locking ring by turning it anti-clockwise.

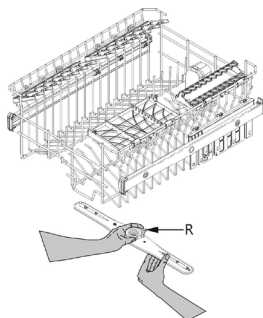

### CLEANING THE OSCILLATING BOTTOM SPRAY ARM

- Take hold of the bottom spray arm unit and pull it upward to release.
  - Separate the oscillating arm **A** from the spray arm **B**.
  - Turn the oscillating arm **A** upside down to release the toothed wheel **C** by pressing the teeth **D** and turning them anticlockwise.
  - Extract the wheel **C** and wash all components under running water.
- Assemble the spray arm unit by reversing the sequence described above.

**Warning:** The wheel **C** can only be mounted in one position; the teeth **D** must engage properly.

Fit the unit so that the wheel **C** is facing **towards the door** of the dishwasher.

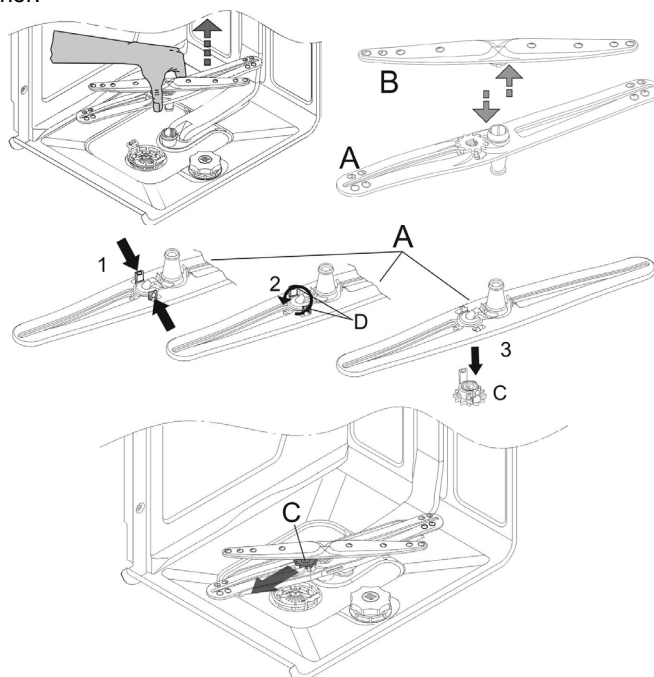

## 6.4 Cleaning the filter unit

- The central filter should be cleaned regularly. To remove it, pull the spray arm assembly upwards.
- Turn the microfilter **M** anticlockwise to release and extract it, then lift the stainless steel filter **F**.
- Push the central filter **H** from below to extract it from the micro-filter.
- Separate the two parts of the plastic filter by pressing the body of the filter in the zone shown by the arrows.
- Remove the central filter by lifting it.

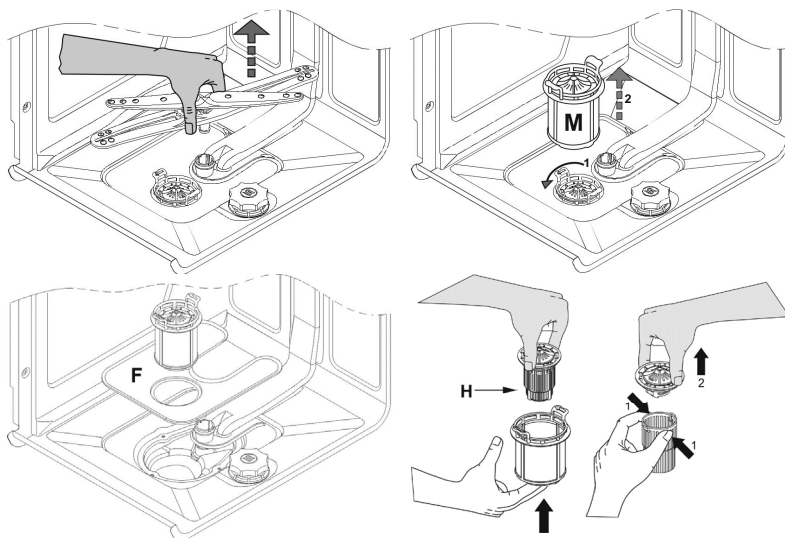

## 6.5 *General warnings and recommendations for correct maintenance*

- Clean the filters **under running water** (at room temperature) using a stiff brush.
- **When removing the filter**, take care that there are no food residues on it. If any residues fall into the washing pit, they might block hydraulic components or foul the spray arm nozzles.
- It is essential to **thoroughly clean the filters** according to the above instructions: the dishwasher cannot function if the filters are clogged.
- **Carefully replace** the filters in their seats, to avoid damaging the wash pump.

### *Prolonged disuse*

- Run the soak program **twice** in succession.
- **Unplug the power** cord from the socket.
- Leave **the door slightly open** in order to prevent the formation of unpleasant odors inside the washing tank.
- **Fill the rinse-aid dispenser.**
- **Shut off the water supply tap.**

***Before starting the dishwasher after prolonged disuse***

- Check that there are no deposits of sludge or rust inside the water pipe: if there are, allow the water to run from the water supply tap for a few minutes.
- **Plug the power cord** back into the socket.
- **Reconnect the water intake hose and open the tap again.**

**6.6 Troubleshooting minor problems**

In some cases it is possible to remedy minor problems by referring to the following instructions:

***If the program fails to start, check that:***

- the dishwasher is connected to the electrical power supply;
- there is no power failure;
- the water tap is open;
- the dishwasher door is properly closed.

***If water remains inside the dishwasher, check that:***

- the drain hose is not kinked
- the drain siphon is not obstructed;
- the dishwasher filters are not clogged.

***If the dishes do not come out clean, check that:***

- the correct amount of detergent has been added;
- there is regenerating salt inside the special container;
- the dishes are being loaded correctly;
- the selected program is suitable for the dish types and their degree of soiling;
- all the filters are clean and positioned correctly;
- the spray arm nozzles are not obstructed;
- there is no object obstructing the rotation of the spray arms.

***If the dishes fail to dry or remain dull, check that:***

- there is rinse aid inside the special container;
- the rinse-aid dispenser setting is correct;
- the detergent used is of good quality and has not lost its effectiveness (for example, through incorrect storage, with the box left open).

***If the dishes show signs of streaking, staining, etc., check that:***

- the rinse aid dispenser setting is not too high.

***If there are visible traces of rust inside the tank:***

- the tank is made of steel, and therefore any rust marks are due to external elements (fragments of rust from the water pipes, pots, cutlery, etc.). Special products are commercially available to remove such marks.
- check that the amount of detergent being used is correct. Certain detergents can be more corrosive than others.
- check that the cap of the salt container is securely closed, and that the water softening setting is correct.



*IF AFTER PERFORMING THE ABOVE TROUBLESHOOTING INSTRUCTIONS THE PROBLEM PERSISTS, CALL THE NEAREST TECHNICAL ASSISTANCE CENTRE.*

***WARNING: ANY OPERATIONS PERFORMED ON THE APPLIANCE BY UNAUTHORIZED PERSONS ARE NOT COVERED BY THE WARRANTY AND SHALL BE PAID FOR BY THE USER.***

7

**IMPORTANT SAFETY INSTRUCTION**

**(Save this instructions)**



THIS MANUAL FORMS AN INTEGRAL PART OF THE APPLIANCE: IT MUST ALWAYS BE KEPT INTACT TOGETHER WITH THE DISHWASHER. BEFORE USING THE APPLIANCE, CAREFULLY READ ALL THE INSTRUCTIONS CONTAINED IN THIS MANUAL.

INSTALLATION MUST BE PERFORMED BY A QUALIFIED TECHNICIAN, IN COMPLIANCE WITH THE REGULATIONS IN FORCE. THIS APPLIANCE IS INTENDED FOR DOMESTIC USE AND SIMILAR APPLICATIONS SUCH AS THE STAFF KITCHENS OF SHOPS, OFFICES AND OTHER WORKPLACES, INSTITUTIONS, AND FOR THE USE OF GUESTS AT HOTELS, HOSTELS, BED AND BREAKFAST ESTABLISHMENTS AND OTHER RESIDENTIAL FACILITIES AND COMPLIES WITH **DIRECTIVES 2006/95/EC AND 2004/108/EC** CURRENTLY IN FORCE, INCLUDING THE PREVENTION AND ELIMINATION OF RADIO FREQUENCY INTERFERENCE. THE APPLIANCE IS DESIGNED FOR THE FOLLOWING PURPOSE: **WASHING AND DRYING OF DISHES**; ANY OTHER USE SHALL BE CONSIDERED IMPROPER. **THE MANUFACTURER DECLINES ALL RESPONSIBILITY FOR USES OTHER THAN THOSE DESCRIBED ABOVE.**



THE NAME PLATE FEATURING THE TECHNICAL DATA, SERIAL NUMBER AND MARKINGS IS VISIBLY POSITIONED ON THE INNER EDGE OF THE DOOR. **THE NAME PLATE MUST NEVER BE REMOVED.**



THIS APPLIANCE IS NOT SUITABLE FOR USE ON BOATS, CARAVANS OR THE LIKE. DISHWASHERS CERTIFIED FOR DOMESTIC USE ARE NOT SUITABLE FOR AUTHORISED FOOD FACTORIES.



CHECK THAT THE VOLTAGE, FREQUENCY AND PROTECTION OF THE DOMESTIC MAINS POWER SUPPLY MATCH THE RATINGS ON THE NAME PLATE OF THE APPLIANCE.



DO NOT LEAVING DISCARDED PACKAGING MATERIALS UNSUPERVISED WITHIN THE HOME. SEPARATE THE VARIOUS PACKAGING MATERIALS AND TAKE THEM TO THE NEAREST SORTED WASTE COLLECTION CENTRE. KEEP CHILDREN, PHYSICALLY AND/OR MENTALLY IMPAIRED ADULTS, AND ANIMALS AWAY FROM PACKAGING WASTE; DANGER OF SUFFOCATION.



*BEFORE PROCEEDING WITH INSTALLATION, DISCONNECT THE MAINS POWER SUPPLY FROM THE WORK AREA.*



*DO NOT USE EXTENSION CORDS, ADAPTORS OR SHUNT CONNECTIONS IN ORDER TO AVOID THE POSSIBILITY OF OVERHEATING OR BURNING WITH CONSEQUENT FIRE HAZARD.*



*DURING INSTALLATION, TAKE CARE NOT TO INJURE YOURSELF ON THE SHARP EDGES OF THE APPLIANCE; WEAR SAFETY GLOVES.*



THE APPLIANCE MUST BE PROVIDED WITH AN EARTH CONNECTION IN ACCORDANCE WITH THE ELECTRICAL SAFETY REGULATIONS IN FORCE.

IF IN DOUBT, HAVE THE SYSTEM CHECKED BY A QUALIFIED ELECTRICIAN (SEE ALSO THE WARNINGS INDICATED IN CHAPTER 3).

**THE MANUFACTURER DECLINES ALL RESPONSIBILITY FOR DAMAGE TO PERSONS OR PROPERTY RESULTING FROM THE FAILURE TO EARTH THE APPLIANCE OR FROM A DEFECTIVE EARTH CONNECTION.**



ALWAYS SWITCH OFF THE DISHWASHER AFTER EACH USE TO AVOID WASTING ELECTRICITY.



IN THE EVENT OF A FAULT, DISCONNECT THE DISHWASHER FROM THE ELECTRICAL POWER SUPPLY AND SHUT OFF THE WATER TAP.



DO NOT USE APPLIANCES WHICH HAVE BEEN DAMAGED DURING TRANSIT! IF IN DOUBT, CONSULT YOUR DEALER. THE APPLIANCE MUST BE INSTALLED AND CONNECTED IN ACCORDANCE WITH THE INSTRUCTIONS PROVIDED BY THE MANUFACTURER OR BY A QUALIFIED TECHNICIAN.



ONLY USE DETERGENTS SPECIALLY FORMULATED FOR DISHWASHERS.

DO NOT USE DETERGENTS FORMULATED FOR WASHING DISHES BY HAND.

ONLY USE RINSE" AID SPECIALLY FORMULATED FOR DOMESTIC DISHWASHERS.





*DO NOT INHALE OR SWALLOW DETERGENT AS THIS MAY CAUSE BURNS AND/OR PERMANENT DAMAGE TO THE NOSE, MOUTH AND THROAT, AND EVEN LEADING TO SUFFOCATION; KEEP DETERGENT AWAY FROM YOUR EYES. IF ONE OF THE ABOVE SITUATIONS OCCURS, SEEK MEDICAL ASSISTANCE IMMEDIATELY.*

*TO PREVENT CHILDREN FROM COMING INTO CONTACT WITH DETERGENT, FILL THE DISHWASHER JUST BEFORE STARTING THE WORK PROGRAM AND THEN KEEP THE DETERGENT OUT OF THE REACH OF CHILDREN.*



*THIS DISHWASHER MUST BE USED BY ADULTS. USE BY PERSONS WITH REDUCED MENTAL AND/OR PHYSICAL CAPABILITIES IS ONLY PERMITTED UNDER THE SUPERVISION OF A PERSON RESPONSIBLE FOR THEIR SAFETY.*

*DO NOT ALLOW CHILDREN TO APPROACH AND/OR PLAY IN OR ON THE DISHWASHER. THE APPLIANCE MAY CONTAIN RESIDUES OF DETERGENT WHICH CAN CAUSE PERMANENT DAMAGE TO THE EYES, MOUTH AND THROAT, AS WELL AS POSSIBLE DEATH BY SUFFOCATION; IF THE ABOVE OCCURS, SEEK MEDICAL ASSISTANCE IMMEDIATELY.*

*BEWARE; IT IS POSSIBLE FOR CHILDREN TO GET TRAPPED INSIDE THE DISHWASHER!*



*DO NOT INTRODUCE SOLVENTS SUCH AS ALCOHOL OR TURPENTINE WHICH MAY CAUSE AN EXPLOSION.*



*DO NOT POUR POWDER AND/OR LIQUID DETERGENT INTO THE RINSE AID CONTAINER AS THIS WILL DAMAGE THE CONTAINER.*

*DO NOT POUR POWDER AND/OR LIQUID DETERGENT INTO THE WASTER SOFTENER TANK AS THIS WILL DAMAGE THE TANK.*

*DO NOT USE INDUSTRIAL DETERGENTS AS THIS MAY DAMAGE THE APPLIANCE AND/OR TRIGGER VIOLENT CHEMICAL REACTIONS (E.G. EXPLOSIVE GAS).*



*DO NOT LOAD DISHES THAT ARE SOILED WITH ASH, WAX OR PAINTS.*



*DO NOT INTRODUCE ITEMS IN HEAT-SENSITIVE PLASTIC, SUCH AS DISPOSABLE CUTLERY OR PLATES, AS THESE MAY BECOME DEFORMED. DO NOT WASH OBJECTS IN PLASTIC UNLESS THEY ARE MARKED "DISHWASHER PROOF" OR THE LIKE. FOR UNMARKED OBJECTS, FOLLOW THE INSTRUCTIONS OF THE MANUFACTURER; IF NO INFORMATION IS AVAILABLE, DO NOT WASH THESE OBJECTS IN THE DISHWASHER.*



DO NOT INTRODUCE ANIMALS INTO THE DISHWASHER.



WHEN OPENING THE DISHWASHER DOOR DURING A CYCLE THERE IS A RISK OF SCALDING DUE TO THE HEAT CONTAINED INSIDE; DO NOT GET IN THE WAY OF THE STEAM LEAVING THE APPLIANCE AND DO NOT TOUCH THE COMPONENTS INSIDE.  
WAIT 20 MINUTES AFTER THE END OF THE WASHING CYCLE OR AFTER INTERRUPTING IT BEFORE REMOVING THE DISHES IN ORDER TO ALLOW THEM TO DRY.



IN CERTAIN SITUATIONS, HYDROGEN MAY BE GENERATED INSIDE A HOT WATER SYSTEM THAT HAS NOT BEEN USED FOR OVER TWO WEEKS.

**HYDROGEN IS AN EXPLOSIVE GAS.** IF THE HOT WATER SYSTEM HAS NOT BEEN USED FOR TWO WEEKS OR MORE, OPEN ALL THE HOT WATER TAPS AND ALLOW THE WATER TO RUN FOR A FEW MINUTES BEFORE USING THE DISHWASHER. THIS WILL DISCHARGE ANY HYDROGEN BUILDUPS. **AS THIS GAS IS FLAMMABLE, DO NOT SMOKE OR USE NAKED FLAMES WHILE PERFORMING THIS OPERATION.**



**LEANING OR SITTING ON THE DISHWASHER DOOR WHEN OPEN MAY CAUSE THE APPLIANCE TO OVERTURN, PUTTING PEOPLE AT RISK. NEVER LEAVE THE DISHWASHER DOOR OPEN; PEOPLE MIGHT TRIP OVER IT.**

DO NOT LEAN AGAINST OR STAND ON THE DISHWASHER RACKS.



DO NOT DRINK THE WATER RESIDUES WHICH MAY BE PRESENT INSIDE THE DISHES OR DISHWASHER.



KNIVES OR OTHER SHARP-ENDED COOKING UTENSILS MUST BE PLACED IN THE CUTLERY BASKET BLADE-DOWN, OR LAID HORIZONTAL IN THE UPPER RACK. TAKE CARE NOT TO CUT YOURSELF AND ENSURE THAT THEY DO NOT PROJECT FROM THE RACK.  
POSITION SHARP/POINTED OBJECTS SO AS TO PREVENT THEM FROM DAMAGING THE DOOR GASKETS.



DO NOT OPERATE THE DISHWASHER UNLESS ALL THE OUTER PANELS HAVE BEEN POSITIONED CORRECTLY.



DO NOT TAMPER WITH THE DISHWASHER CONTROLS.



**AQUASTOP MODELS;** THE AQUASTOP DEVICE PREVENTS FLOODING IN THE EVENT OF A WATER LEAK. WHEN THE AQUASTOP DEVICE IS TRIPPED (THE ERROR IS INDICATED ON THE DISPLAY), CALL IN A QUALIFIED TECHNICIAN TO IDENTIFY AND REPAIR THE FAULT. IN MODELS EQUIPPED WITH THE AQUASTOP DEVICE, THERE IS A SOLENOID VALVE INSIDE THE WATER INTAKE HOSE. **DO NOT CUT THE HOSE AND DO NOT ALLOW THE SOLENOID VALVE TO DROP INTO WATER.** IN THE EVENT OF DAMAGE TO THE WATER INTAKE HOSE, DISCONNECT THE APPLIANCE FROM THE ELECTRICAL POWER SUPPLY AND FROM THE WATER SUPPLY.

IMMEDIATELY AFTER INSTALLING THE DISHWASHER, PERFORM A QUICK TEST OF THE APPLIANCE (SEE "INSTALLATION" MANUAL). IF THE DISHWASHER FAILS TO OPERATE CORRECTLY, DISCONNECT IT FROM THE ELECTRICAL POWER SUPPLY AND CALL THE NEAREST TECHNICAL SERVICE CENTRE. **DO NOT ATTEMPT TO REPAIR THE APPLIANCE.**



THE DISHWASHER MEETS ALL THE REQUIREMENTS SET OUT BY THE REGULATIONS IN FORCE CONCERNING SAFETY AND ELECTRICAL EQUIPMENT. ANY TECHNICAL CHECKS SHOULD BE CONDUCTED EXCLUSIVELY BY A TRAINED AND AUTHORIZED TECHNICIAN: **REPAIRS CARRIED OUT BY UNAUTHORIZED PERSONS WILL INVALIDATE THE WARRANTY, AS WELL AS POSING A POTENTIAL HAZARD TO THE USER.**



BEFORE CLEANING OR SERVICING THE APPLIANCE, REMOVE THE PLUG OR TURN OFF THE MULTI-POLE SWITCH.



REMOVE THE WASHING COMPARTMENT DOOR AND DISCONNECT THE MAINS POWER SUPPLY WHEN REMOVING THE OLD DISHWASHER FOR MAINTENANCE OR DISPOSAL.



THE SYMBOL  ON THE PRODUCT, OR ON THE DOCUMENTS ACCOMPANYING THE PRODUCT, INDICATES THAT THIS APPLIANCE MAY NOT BE TREATED AS HOUSEHOLD WASTE. INSTEAD IT SHALL BE HANDED OVER TO THE APPLICABLE COLLECTION POINT FOR THE RECYCLING OF ELECTRICAL AND ELECTRONIC EQUIPMENT. DISPOSAL MUST BE CARRIED OUT IN ACCORDANCE WITH LOCAL ENVIRONMENTAL REGULATIONS FOR WASTE DISPOSAL. FOR MORE DETAILED INFORMATION ABOUT TREATMENT, RECOVERY AND RECYCLING OF THIS PRODUCT, PLEASE CONTACT YOUR LOCAL CITY OFFICE, YOUR HOUSEHOLD WASTE DISPOSAL SERVICE OR THE SHOP WHERE YOU PURCHASED THE PRODUCT.



BY ENSURING THIS PRODUCT IS DISPOSED OF CORRECTLY, YOU WILL HELP PREVENT POTENTIAL NEGATIVE CONSEQUENCES FOR THE ENVIRONMENT AND HUMAN HEALTH.



**THE MANUFACTURER DECLINES ALL RESPONSIBILITY FOR DAMAGE TO PERSONS, ANIMALS OR PROPERTY RESULTING FROM FAILURE TO OBSERVE THE ABOVE PRECAUTIONS, FROM TAMPERING WITH EVEN A SINGLE COMPONENT OF THE APPLIANCE, OR FROM THE USE OF UNORIGINAL SPARE PARTS. IF IN DOUBT ABOUT THE CONTENTS OF THIS MANUAL, CONTACT THE TECHNICAL ASSISTANCE SERVICE.**



DO NOT USE STEAM CLEANERS TO CLEAN THE DISHWASHER.



**WARNING:** SOME DISHWASHER DETERGENTS ARE STRONGLY ALKALINE. THEY CAN BE EXTREMELY DANGEROUS IF SWALLOWED. AVOID CONTACT WITH THE SKIN AND EYES AND KEEP CHILDREN AWAY FROM THE DISHWASHER WHEN THE DOOR IS OPEN. CHECK THAT THE DETERGENT RECEPTACLE IS EMPTY AFTER COMPLETION OF THE WASH CYCLE.

## 8 INSTALLATION AND HOOK-UP

**To install and hook up this appliance, consult the attached installation manual.**

Bear in mind the following warnings when installing and hooking up the dishwasher.



*DURING INSTALLATION, TAKE CARE NOT TO INJURE YOURSELF ON THE SHARP EDGES OF THE APPLIANCE; WEAR SAFETY GLOVES.*



**INSTALLATION, REPAIRS AND SERVICING MUST BE PERFORMED BY QUALIFIED AND AUTHORIZED TECHNICIANS.** AS WELL AS INVALIDATING THE WARRANTY, WORK CARRIED OUT BY UNAUTHORIZED PERSONS MAY GENERATE HAZARDS. INSTALLATION MUST BE PERFORMED IN COMPLIANCE WITH ALL THE DIRECTIVES IN FORCE IN THE COUNTRY OF INSTALLATION AND, IF THESE DO NOT EXIST: IN THE UNITED STATES THE NATIONAL ELECTRIC CODE; IN CANADA THE CANADIAN ELECTRIC CODE C22.1 - LATEST EDITION/PROVINCIAL AND MUNICIPAL CODES AND/OR LOCAL CODES.



**BUILDING-IN A DISHWASHER UNDERNEATH A CERAMIC HOB IS ABSOLUTELY FORBIDDEN.** A DISHWASHER CAN BE BUILT-IN UNDERNEATH A CONVENTIONAL HOB PROVIDED THERE IS **NO BREAK** IN THE KITCHEN WORKTOP, AND THE DISHWASHER AND HOB ARE **INSTALLED AND SECURED CORRECTLY**, SO THAT **NO HAZARDS ARE GENERATED.**



**PREVENTING THE RISK OF CLOGGING OR DAMAGE:** IF THE WATER PIPE IS NEW OR HAS NOT BEEN USED FOR A LONG TIME, BEFORE CONNECTING TO THE WATER SUPPLY CHECK THAT THE WATER IS CLEAR AND FREE OF IMPURITIES, TO PREVENT DAMAGE TO THE APPLIANCE. **THE DISHWASHER MUST ALWAYS BE CONNECTED TO THE WATER SYSTEM WITH NEW HOSES; OLD OR USED HOSES MUST NEVER BE REUSED.**



CHECK THAT THE VOLTAGE AND THE FREQUENCY OF THE MAINS MATCH THE RATINGS ON THE NAME PLATE OF THE APPLIANCE POSITIONED ON THE INNER EDGE OF THE DOOR.



**IN THE EVENT OF DAMAGE TO THE SUPPLY CORD, HAVE IT REPLACED BY THE MANUFACTURER OR AN AUTHORIZED TECHNICAL SERVICE CENTRE.**

*THIS APPLIANCE MUST BE EARTHED. IN CASE OF A MALFUNCTION OF FAULT, THE EARTH REDUCES THE RISK OF ELECTROCUTION BY PROVIDING THE ELECTRICAL CURRENT WITH AN ALTERNATIVE, LESS RESISTANT PATH.*



*BEFORE MAKING ELECTRICAL CONNECTIONS, DISCONNECT THE MAINS POWER SUPPLY FROM THE WORK AREA.*



*CHECK THAT THE MAINS SUPPLY IN THE PLACE OF INSTALLATION COMPLIES WITH THE REGULATIONS IN FORCE IN THE COUNTRY OF USE, AND THAT IT IS CORRECTLY EARTHED.*



*THIS APPLIANCE MUST BE EARTHED. IN CASE OF A MALFUNCTION OR FAULT, THE EARTH REDUCES THE RISK OF ELECTROCUTION BY PROVIDING THE ELECTRICAL CURRENT WITH AN ALTERNATIVE, LESS RESISTANT PATH. THIS APPLIANCE IS FITTED WITH A SUPPLY CORD CONTAINING AN EARTH WIRE AND PLUG. FIT THE PLUG INTO A SUITABLE SOCKET, INSTALLED AND EARTHED IN COMPLIANCE WITH THE LAWS IN FORCE IN THE COUNTRY OF INSTALLATION.*



*AN INCORRECTLY CONNECTED EARTH WIRE MAY GENERATE THE RISK OF ELECTROCUTION. IF IN DOUBT AS TO THE CORRECT EARTHING OF THE APPLIANCE, CALL IN A QUALIFIED ELECTRICIAN OR THE TECHNICAL ASSISTANCE SERVICE. DO NOT CHANGE THE PLUG ATTACHED TO THE APPLIANCE. IF THE PLUG IS NOT SUITABLE FOR THE SOCKET, CALL IN A QUALIFIED ELECTRICIAN TO FIT A SUITABLE PLUG.*



*IN THE EVENT OF DAMAGE TO THE SUPPLY CORD, HAVE IT REPLACED BY THE MANUFACTURER OR AN AUTHORIZED TECHNICAL SERVICE CENTRE IN ORDER TO AVOID ANY RISK.*



*DO NOT USE EXTENSION CORDS, ADAPTORS OR SHUNT CONNECTIONS IN ORDER TO AVOID THE POSSIBILITY OF OVERHEATING OR BURNING, WITH CONSEQUENT FIRE HAZARD.*

## 9 TECHNICAL DATA (SEE TAB. 9-01)

<b>Width</b>	44.7 cm - 44.9 cm (17-19/32"; 17-43/64")
<b>Depth measured flush with the outer edge of the control panel</b>	55 cm (21-21/32")
<b>Height</b>	from 82 cm to 87 cm (from 32-9/32" to 34-1/4")
<b>Capacity</b>	10 standard place-settings
<b>Water supply pressure</b>	min.7 - max. 130 PSI (min. 0.5 – max. 9 bar)
<b>Electrical characteristics</b>	See rating plate
Tab. 9-01	