

SEPITH18-454

Halogen lights. This model is not available with heat lamps. Shown with optional duct cover (sold separately). Optional duct covers are available in standard and custom sizes.

Dimensional Information

Width	54.0
Depth	30.0
Height	18.0
CFM @ 0.0" SP	1100.0
Sones	6.4
Amps	7.8
# Lights	4.0

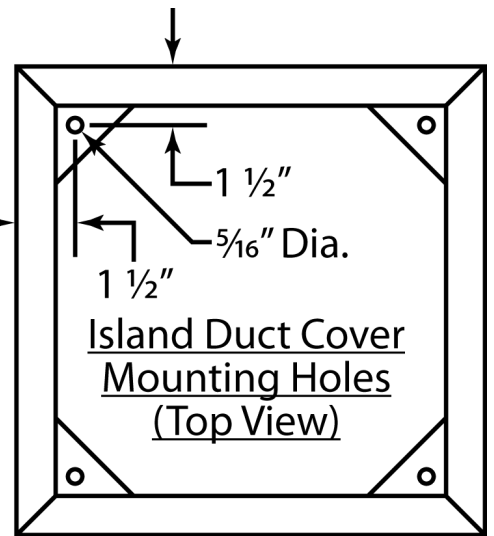
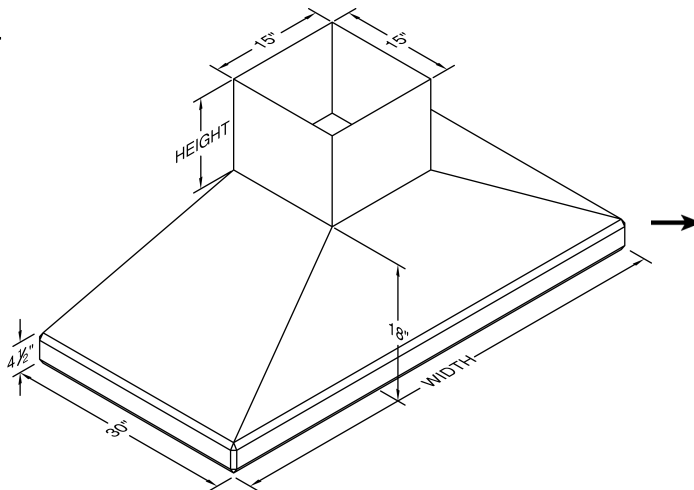

Connection Diagram

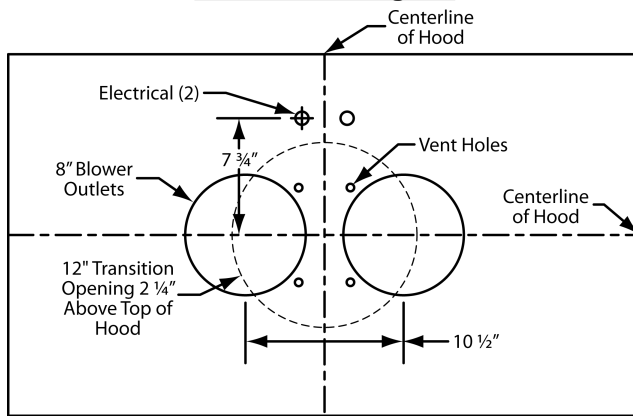

1100 CFM T400 Cluster Blower (Top View)

Recommended Mounting Height*

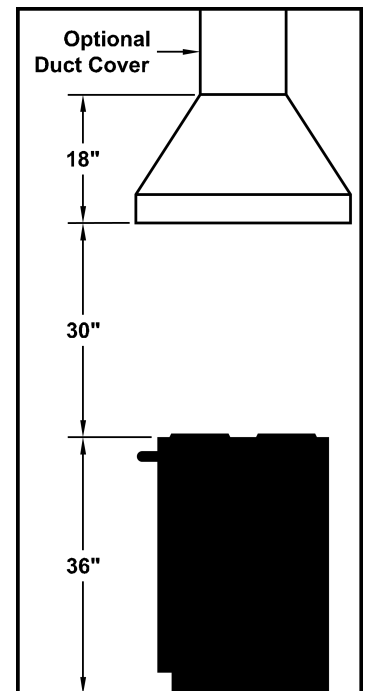

*Exceeding recommended mounting height may compromise performance.

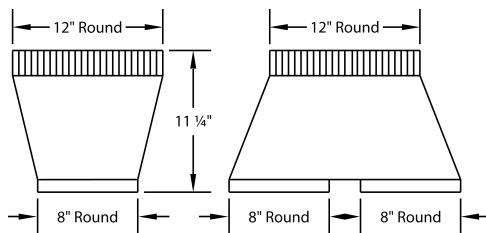

VP564 Standard Transition (Included)

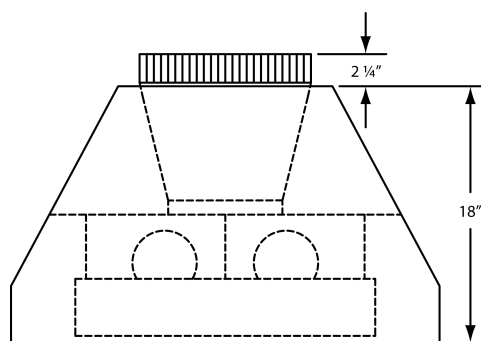

Transition Installed (Side View)

Electrical/Mechanical Specifications For Blower Unit

Model	Volts	Amps*	Hz	RPM	CFM SP@0.0"	Equivalent CFM	CFM SP@0.1"	CFM SP@0.2"	CFM SP@0.3"	Minimum Round Duct Size	Sones#
T400 Island Cluster	115.0	5.8	60.0	1550.0	1100.0	1800.0	998.0	855.0	774.0	12" (113 sq. in.)	6.4

+ This model is equipped with halogen lighting (one in each corner).

\$ Because the Magic Lung® blower uses centrifugal filtration rather than conventional baffle or mesh filters, the Magic Lung® blower can handle cooking equipment with higher cubic feet per minute (CFM) requirements and can deliver equivalent CFM much more efficiently than other filtration systems. When comparing the Magic Lung® with other blower units made by other manufacturers, use the "Equivalent CFM".

Ratings in accordance with the Standard Test Code by the Energy Systems Laboratory of the Texas Engineering Experiment Station.