

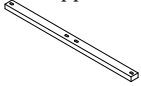

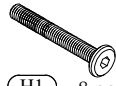

Components and Hardware List

Mirror Frame  (A) 1 pc.	Support Bar  (B) 2 pcs.	Ø1/4" x 1-1/2" Allen Head Bolt  (H1) 8 pcs.	Ø1/4" x Ø10mm Spring Washer  (H2) 8 pcs.	Ø1/4" x Ø19mm Flat Washer  (H3) 8 pcs.	M4 x 2-1/2" Allen key  (H4-1) 1 pc.	M4 x 4" Straight Allen key  (H4-2) 1 pc.
--	--	---	--	--	---	--



58061 Mirror

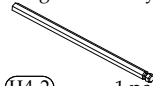
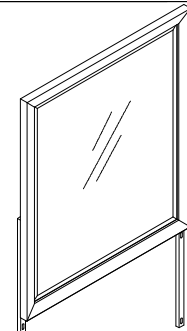
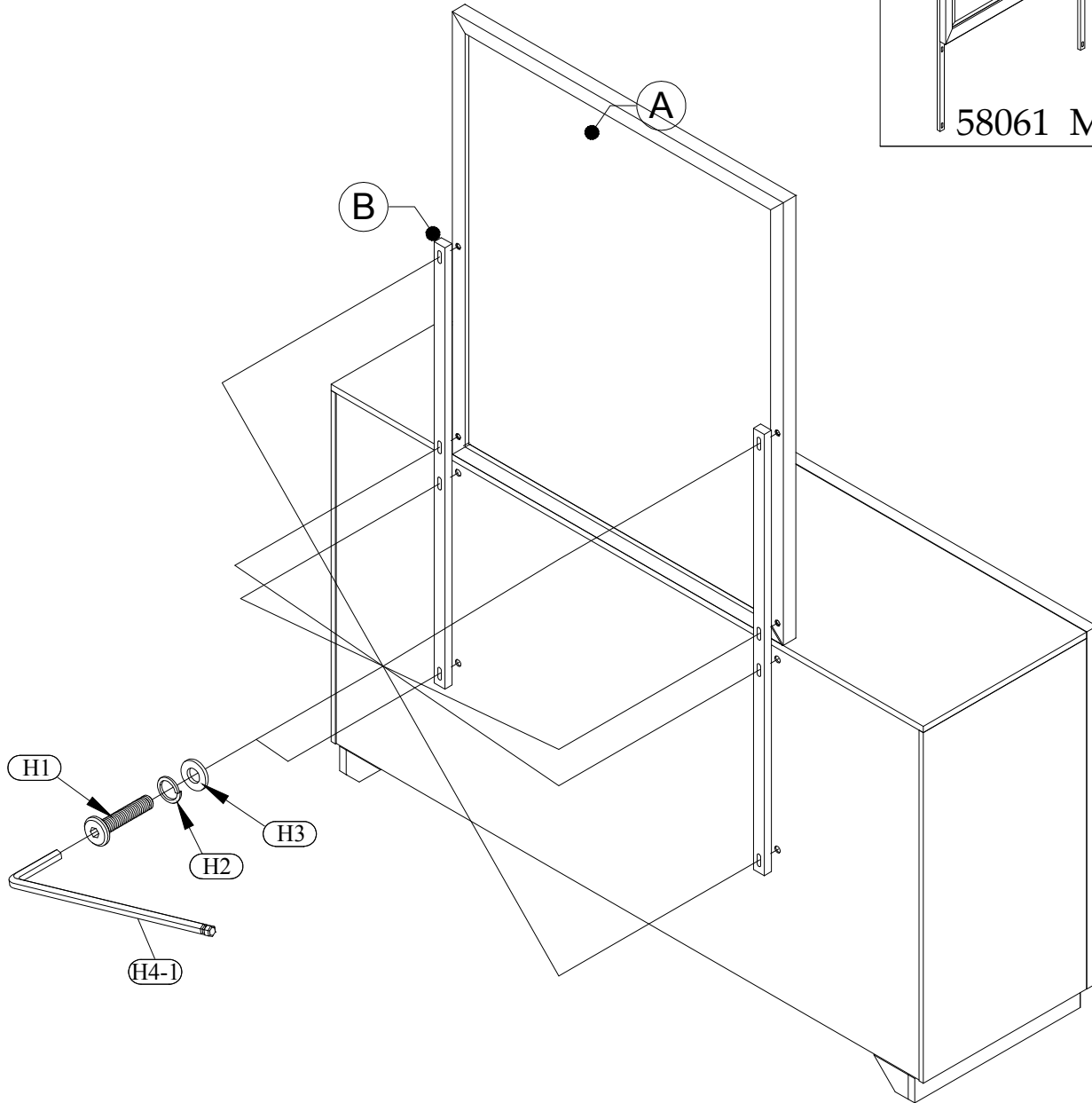

To prevent possible scratches and damage, this furniture must be assembled by two people on a soft surface such as a blanket or carpet.

- Step 1. Using two people, carefully move the Dresser to be a few inches from the wall, near where it will be used.
2. Attach the Support Bars (B) to the back of dresser with the Allen Head Bolts (H1), Spring Washers (H2) and Flat Washers (H3) but do not fully tighten Bolts.
3. Place the Mirror onto the top back edge of the Dresser, against the Support Bars. Attach to the Support Bars using the same Bolts and Washers as in previous Step.
4. Tighten all Bolts using the Allen Wrench (H4).
5. Carefully move the Dresser back to near the wall.