

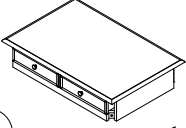

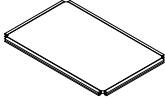



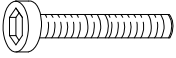

Components and Hardware List

Leg	Table Top	Shelf	L-Bracket
 (A) 4 pcs.	 (B) 1 pc.	 (C) 1 pc.	 (D) 4 pcs.
M5/16"-18 x 2-1/4" Long Allen Head Bolt  (E) 4 pcs.	M5/16"-18 x 5/8" Allen Head Bolt  (F) 8 pcs.	5/16" Spring Washer  (G) 12 pcs.	5/16" *19*2mm Flat Washer  (H) 12 pcs.
5mm Allen Wrench  (I) 1 pc.	Caster  (J) 4 pcs.	16mm Open Wrench  (K) 1 pc.	

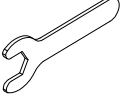
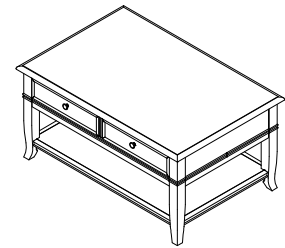

#51702
Cocktail Table

Be sure to check all packing material carefully for small parts, which may have come loose inside the carton during shipment.

The Top has been secured to the apron frame for shipping and to assist in assembly. Do not remove the security strap until after the table has been completely assembled.

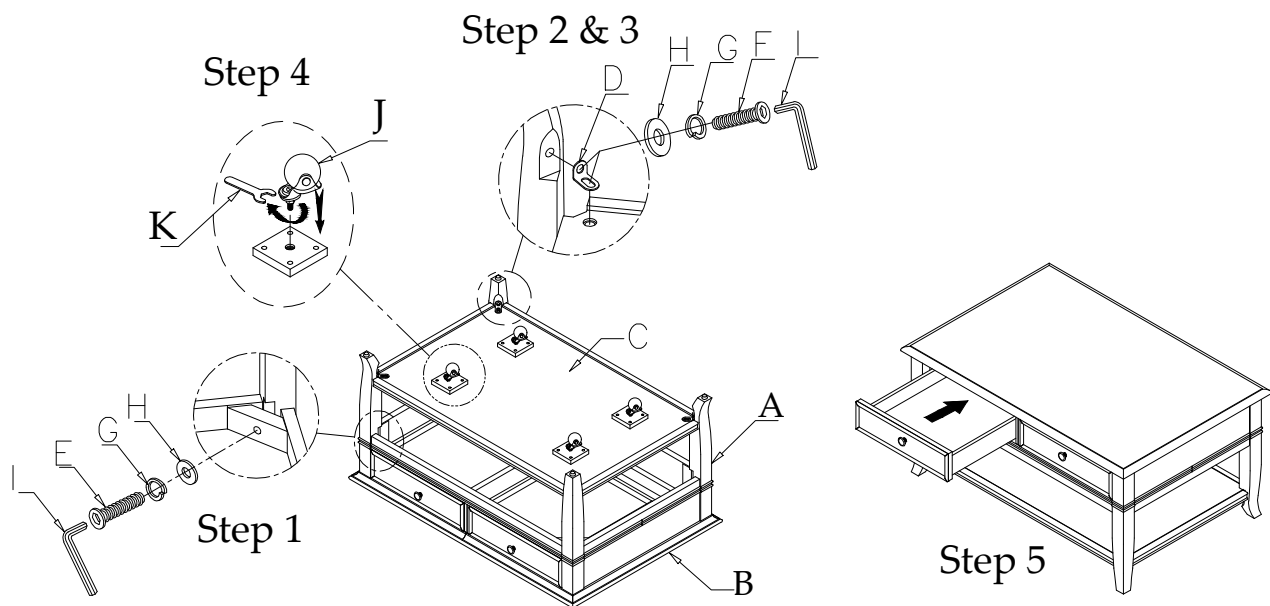

Step 1: Place the Table Top upside down. Attach three Legs (A) into corners of the Table Top using the Long Allen Head Bolts (E), Spring Washers (G) and Flat Washers (H). Do not fully tighten until after Step 3.

Step 2: Position the Shelf (C) into the notches of the three Legs already attached. Position the fourth Leg into the corner of the Table Top and Shelf. Attach the leg to the table top using the same Bolts and Washers as in previous step.

Step 3: Attach the Shelf to the Legs using the L-Brackets (D) and the Long Bolts (F), Spring Washers (G) and Flat Washers (H). While pulling the Legs into the notch, tighten the Bolts with the Allen Wrench (I).

Step 4: If the Casters (J) will be used, install into the four plates mounted under the Shelf. Tighten with the Open Wrench (K).

Step 5: Carefully set the completed Table upright.

The casters provide an element of convenient mobility, however, to prevent possible damage to some types of flooring, never roll casters on unprotected hardwood or vinyl flooring.