

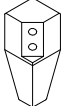

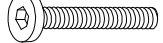



## Components and Hardware List

<p><b>Bun Foot</b></p>  <p><b>(A)</b> 4 pcs.</p>	<p><b>5/16"-18 x 2" Long Allen-Head Bolt</b></p>  <p><b>(B)</b> 8 pcs.</p>	<p><b>5/16" Spring Washer</b></p>  <p><b>(C)</b> 8 pcs.</p>	<p><b>5/16" x 19*2mm Flat Washer</b></p>  <p><b>(D)</b> 8 pcs.</p>
<p><b>5mm Allen Wrench</b></p>  <p><b>(E)</b> 1 pc.</p>	<p><b>Anti-Tipping Restraint Kit</b></p>  <p><b>(F)</b> 1 pc.</p>	<p><b>Center Support Leg</b></p>  <p><b>(G)</b> 1 pc.</p>	<p><b>Wood Shelf</b></p>  <p><b>(H)</b> 1 pc.</p>
<p><b>Door</b></p>  <p><b>(I)</b> 1 pc.</p>	<p><b>Shelf Support</b></p>  <p><b>(J)</b> 8 pcs.</p>		

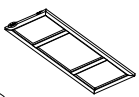
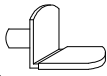
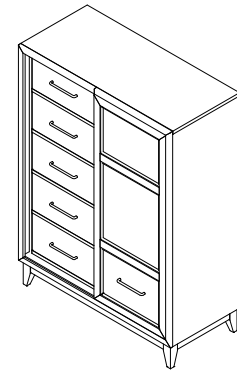

#46166  
GENTLEMAN'S CHEST

Be sure to check all packing material carefully for small parts, which may have come loose inside the carton during shipment.

To prevent possible scratches and damage, this furniture must be assembled by two people on a soft surface such as a blanket or carpet.

**Step 1:** Place the Gentleman's Chest on its back. Attach a Bun Foot (A) underneath each corner of the Chest using the 2" Allen Head Bolts (B), Spring Washers (C) and Flat Washers (D). Tighten using the Allen Wrench (E).

**Step 2:** Install the Leveler (H) into the bottom end of the Center Support Leg. Attach the Support Leg to the bottom of the Gentleman's Chest as shown. The Leveler can be adjusted if necessary to provide support for the middle of the Gentleman's chest.

**Step 3:** Install the four Shelf Supports (J) into the holes behind the Door. Place the Wood Shelf (H) on the Shelf Supports.

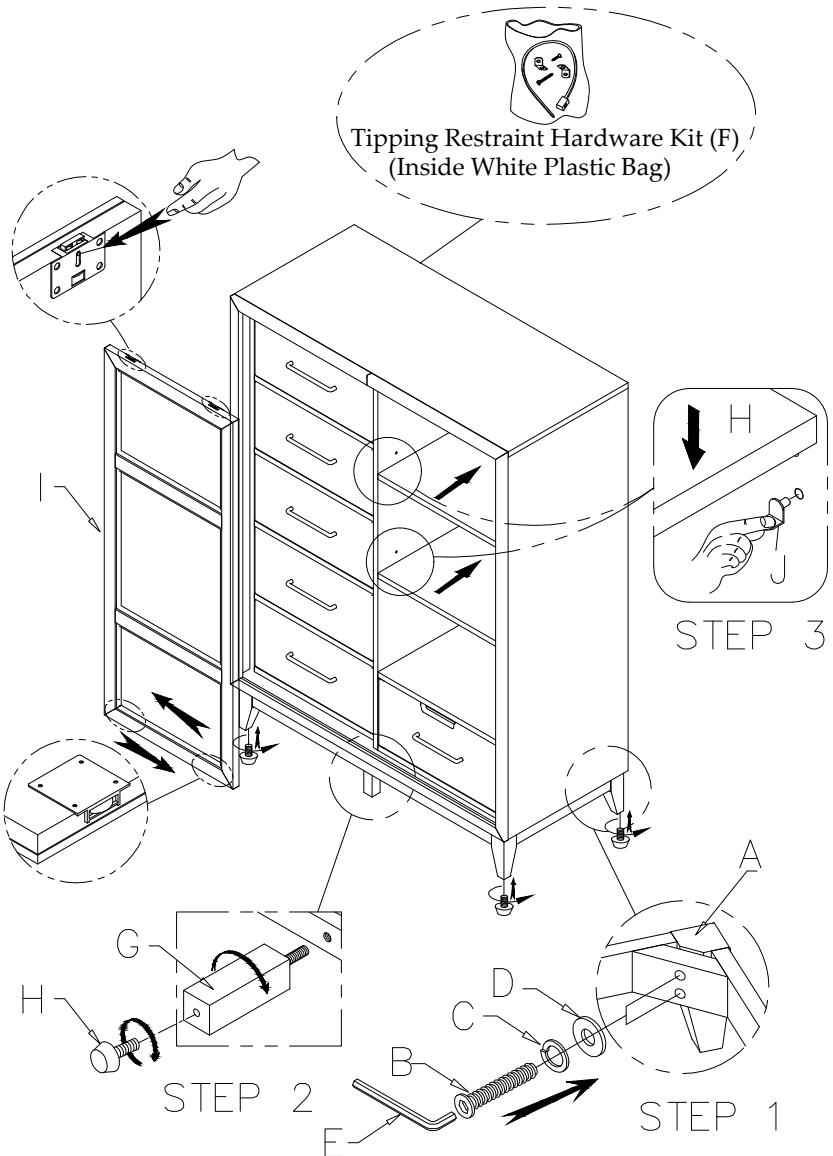

To install the Sliding Door:

- A: The guide pins on the Upper Guides must be retracted by pressing down on the tip of the guide pin until it clicks and is locked in a retracted position.
- B: Install the sliding door by placing the bottom guide rollers of the door onto the track installed in the shelf below.
- C: Fix the top end by pressing in on the upper guide pin and pushing the pin upward, with the pin going into the groove above.

Check door for smooth operation and fit. If required, door "fit" can be modified by adjusting the rollers at the bottom of the doors. Refer to the diagram below.

If the door must be removed from the cabinet, place the tip of your finger on the button of the top mechanism and hook your fingernail at the top edge of the button. If you have very short fingernails, a small flat screwdriver can also be used. While pressing in on the button, using your fingernail slide the button down until it locks down in the retracted position. Repeat for the other guide pin. Carefully tilt the top of the door outward, lift door out of the bottom track and lay door on a soft surface.

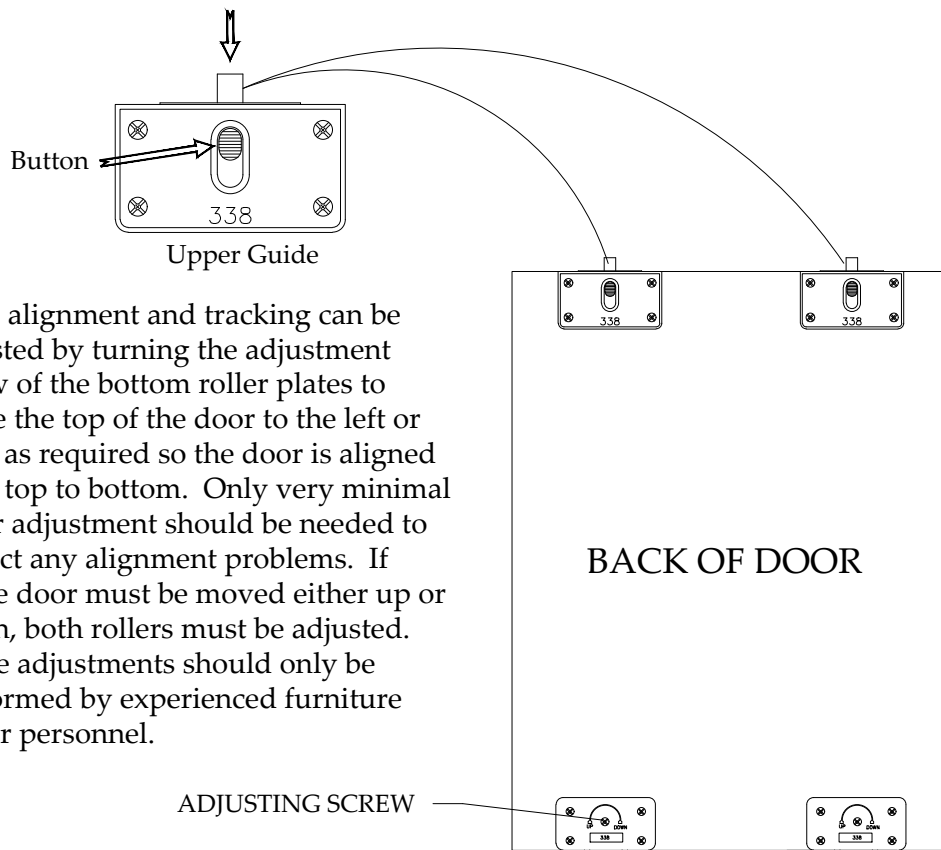

Door alignment and tracking can be adjusted by turning the adjustment screw of the bottom roller plates to move the top of the door to the left or right as required so the door is aligned from top to bottom. Only very minimal roller adjustment should be needed to correct any alignment problems. If entire door must be moved either up or down, both rollers must be adjusted. These adjustments should only be performed by experienced furniture repair personnel.

Adjusting this roller down will move the top of the door to the right.  
Adjusting roller up will move the top of the door to the left.

Adjusting this roller down will move the top of the door to the left.  
Adjusting roller up will move the top of the door to the right.

Notice: Riverside Furniture Corp. recommends that steps be taken for certain furniture items to prevent or minimize the risk of tip-over. This furniture is equipped with Tip-over Restraint Hardware for use to minimize this risk, if used. Please follow below installation steps. Riverside Furniture Corp. recommends that parents and guardians periodically visit the U.S. Consumer Product Safety Commission (CPSC) website at <http://www.cpsc.gov/> and stay up to date on all issues related to children's product safety.

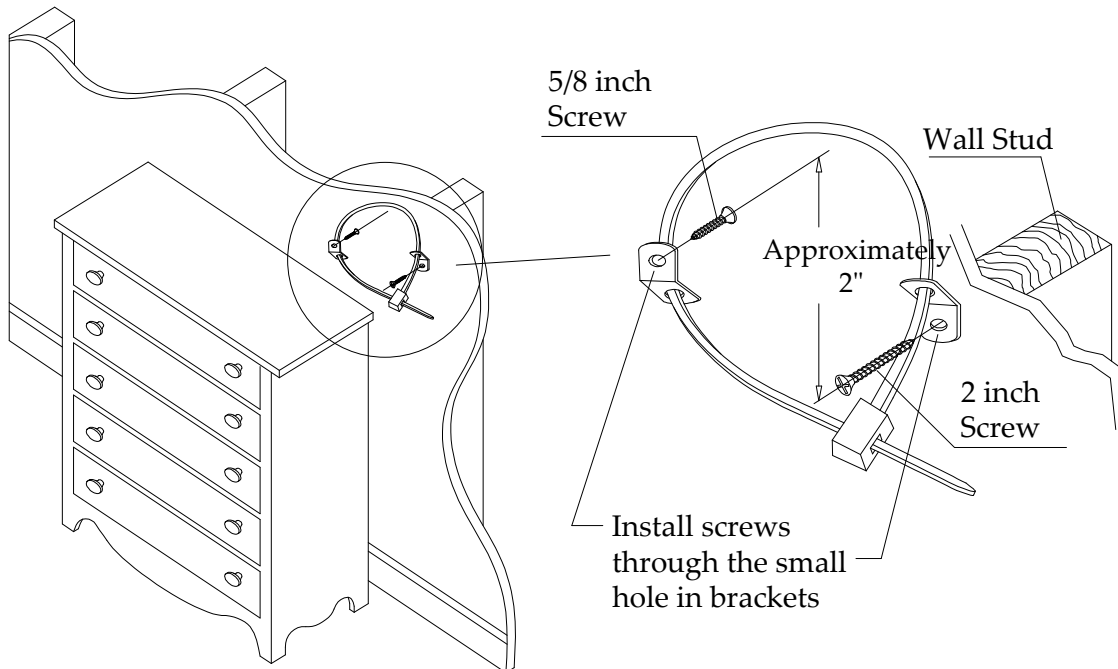

1. Temporarily locate the furniture to near it's final location in the room next to a wall. Locate a wall stud behind your furniture and also mark the stud's location on the back of your furniture.
2. Firmly attach one bracket to the stud approximately 2" below the top of the furniture with the **2 inch long** Wood Screws provided. It may be necessary to drill 3/32 dia. pilot holes for the screws.
3. Firmly attach the other bracket onto a solid, structural part on the back of the furniture using the **5/8 inch long** Wood Screws. It may also be necessary to pilot bore for these screws.
4. Move the furniture into its final position, taking care to line up the wall bracket with the furniture bracket. Thread a strap through the bracket as shown in the illustration. Tighten strap until snug but do not over tighten.

**Caution:** Riverside Furniture Corp. assumes no liability for improper installation or excessive loads placed on screws, brackets or straps. Failure to detach this restraint before moving furniture may result in personal injury and property damage.

**Warning:** This tip-over restraint is not to be a substitute for proper adult supervision. Do not allow children to climb on furniture. Items left on top of the TV and furniture, such as toys, remote controls and treats might tempt young children to climb. Push the TV as far back as possible from the front of its stand. Place electrical cords out of a child's reach, and teach children not to play with the cords.