

Components and Hardware List

Anti-Tip Restraint Kit

File Bar

H1

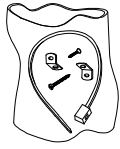

2 pcs.

A

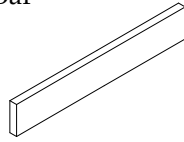

6 pcs.

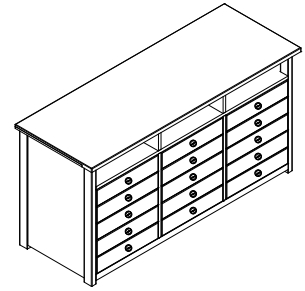

28035 / 28135 / 28235



Tipping Restraint Hardware Kit (E)
(Inside White Plastic Bag)

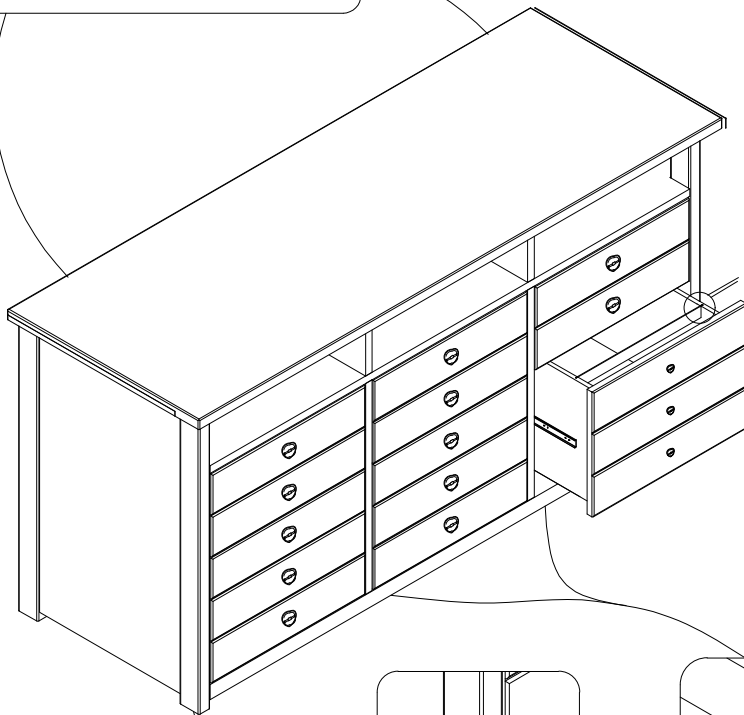

For product and personal safety, an Anti-Tip Restraint kit has been included with this cabinet which can help to minimize the risk of the cabinet accidentally tipping forward, if used and properly installed.

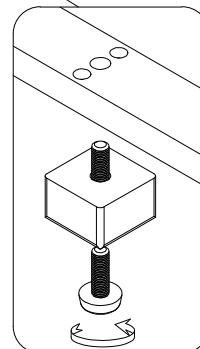
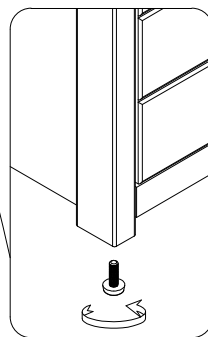
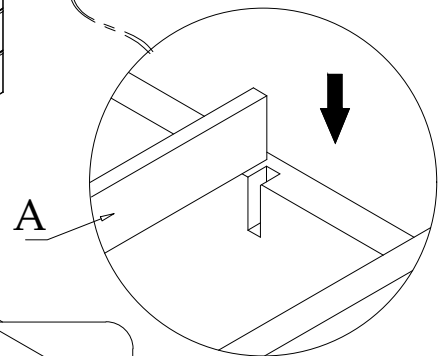

There are levelers underneath the Console which can be adjusted to compensate for uneven flooring. If the furniture wobbles, determine which corner does not touch the floor correctly. With two people follow these steps:

1. Carefully elevate the item slightly to provide access to the levelers attached to the bottom.
2. Turn the levelers until adequate contact will be made with the floor. Gently set down the piece and check stability.

Repeat steps until furniture sits firmly on the floor.