

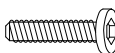





Components and Hardware List

Ø5/16-18 x 2" long Allen Head Bolt  (A) 4 pcs.	Ø5/16-18 x 2-1/2" long Allen Head Bolt  (B) 4 pcs.	5/16" Spring Washer  (C) 8 pcs.
5/16" Flat Washer  (D) 8 pcs.	5mm Allen Wrench  (E) 1 pc.	Table Top  (F) 1 pc.
Table Column  (G) 1 pc.	Table Base  (H) 1 pc.	Bridge  (I) 1 pc.

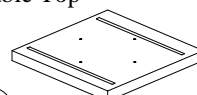
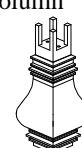

#23609 END TABLE

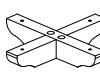
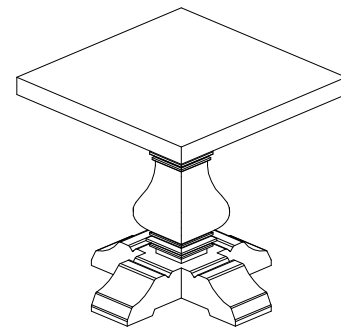
Be sure to check all packing material carefully for small parts, which may have come loose inside the carton during shipment. Separate and check all parts against the Components and Hardware List above.

Step 1: Position the Bridge on top of the Table Column and attach using the 2-1/2" Allen Head Bolts (B), Spring Washers (C) and Flat Washers (D). Tighten with the Allen Wrench (E).

Step 2: Place the Table Top (F) upside down on a soft surface such as a blanket or carpet. Position the assembled Bridge and Column on the Table Top and attach using the 2" Allen Head Bolts (A), and the same Washers as before. Tighten with the Allen Wrench.

Step 3: Position and attach the Table Base (H) to the bottom of the Column using the 2-1/2" Allen Head Bolts (B), and the same Washers as before. Tighten with the Allen Wrench.

Set the assembled Table upright.

