

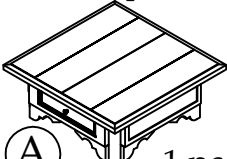

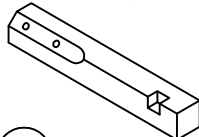

**Components and Hardware List**

<p>Table Top</p>  <p>(A) 1 pc.</p>	<p>Leg</p>  <p>(B) 4 pcs.</p>	<p>Bottom Panel</p>  <p>(C) 1 pc.</p>	<p>4mm Allen Wrench</p>  <p>(D) 1 pc.</p>
<p>Ø1/4 x 2" Allen Head Bolt</p>  <p>(E) 12 pcs.</p>	<p>1/4" Spring Washer</p>  <p>(F) 12 pcs.</p>	<p>1/4" Flat Washer</p>  <p>(G) 12 pcs.</p>	

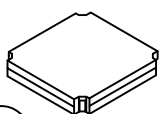

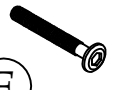
#17209  
Square End Table

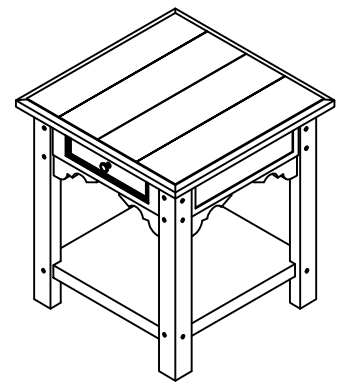
Be sure to check all packing material carefully for small parts, which may have come loose inside the carton during shipment.

To prevent possible scratches and damage, this furniture should be assembled on a soft surface such as a blanket or carpet.

Note: All bolts should be left loose until the table is completely assembled, then tighten all bolts with the allen wrench provided.

