

FULL MOTION DUAL STUD MOUNTS

PDX650

This is probably what you imagined before you started shopping for a mount.

The PDX650 from Kanto is a full motion TV wall mount that allows your flat screen TV to sit 2" from the wall. Its generous tilt and swivel capabilities are complemented by 21.8" of extension, making it easy to place your TV in the most optimal position. Magnetic wall plate covers are also included to hide any sign of installation. Exceptionally strong yet lightweight enough to make installation a breeze, this TV wall mount will ensure your TV remains safe and secure.

Available in black or white. White model includes white cable sleeve.

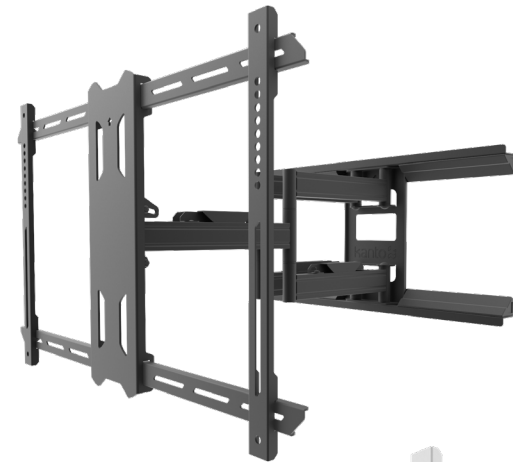

FEATURES & SPECIFICATIONS

- Fits most flat panel TVs from 37" to 75"
- Supports TVs up to 125 lb (57 kg)
- Accommodates VESA sizes from 200x100 to 600x400
- Accessible tilt mechanism provides a +15° to -3° viewing angle
- 80° of swivel in either direction, depending on screen size
- Sits 2" (5 cm) and extends up to 21.8" (55.3 cm) from the wall
- Integrated cable management
- Adjustable horizontal leveling
- 22" (56 cm) dual stud wall plate accommodates up to 16" stud spacing,
- Solid steel construction with durable powder coated finish
- Includes manual and all mounting hardware for wood stud and concrete installation
- Five year manufacturer's warranty
- Shipping box weight: 24.7 lb (11.2 kg)
- Shipping Box Dimensions: 29.4" x 15" x 2.8" (74.6 x 38 x 7 cm)
- Product Weight: 22.5 lb (10.2 kg)
- UPC: 800152713038 - PDX650
- UPC: 800152713045 - PDX650W

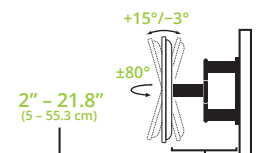
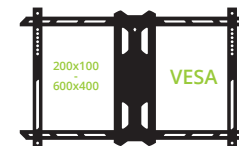
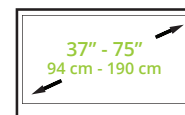

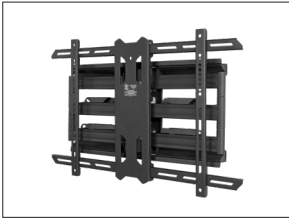

LOW PROFILE DESIGN

With a unique tilt head designed to nestle into the frame, the PDX650 lets you push your TV within 2" of the wall. The H frame assembly provides maximum access for cable connections.

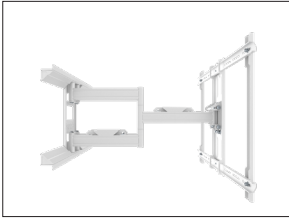

EXTENDS ALMOST 22 INCHES

Even with its low-profile design, the PDX650 can extend almost 22" from the wall, giving you plenty of room for tilting and swiveling your TV, or for reaching out from alcoves.



18 DEGREES OF TILT

In order to provide you with the ideal viewing angle, the PDX650 can easily be tilted forward 15° or backward 3°. Experiment with the best viewing angle and know that it can be securely locked in place. Once you've found the best viewing angle, tighten the nuts to secure your TV in place.

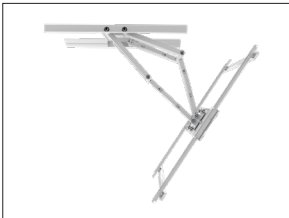

WIDE RANGE OF SWIVEL

The articulating arms allow you to swivel your TV 80° in either direction, depending on your TV size, allowing you to achieve the perfect viewing angle.



PROFESSIONAL APPEARANCE

The PDX650 comes with four magnetic wall plate covers to hide any sign of installation, as well as cable management raceways to keep your viewing area tidy. The white model also includes a white cable sleeve to match the surrounding area.



EVERYTHING YOU NEED

We supply you with everything except a toolbox to ensure that your installation goes smoothly. Instruction manuals are provided in English, French, and Spanish, as well as the parts you need to mount your TV safely and securely. Easy-to-follow online videos and phone support are available to assist you along the way.

TECHNICAL ILLUSTRATIONS

