



Stealthbox®

INSTALLATION GUIDE
for the

SB-GM-SLVD/10TW1

SKU# 94611 - 94614

2014 & Up Chevrolet Silverado/GMC Sierra Double Cab

Enclosure Type: Sealed

Driver Type: 10TW1-4

Nominal Impedance: 2 ohms

Continuous Power Handling: 600 watts (RMS method)

! IMPORTANT

If you choose to perform the installation yourself, it is absolutely vital that the Stealthbox® be properly mounted to the vehicle according to these instructions. Failure to mount the enclosure properly presents two problems:

- 1) The sub-bass performance will suffer due to the movement of the enclosure caused by the force exerted by the woofer(s).
- 2) A loose enclosure presents a serious safety hazard in the event of a collision or sudden deceleration.

INSTALLATION
DIFFICULTY:

1 OUT OF 5

ESTIMATED TIME:
1 HOUR



Thank you for choosing a JL Audio Stealthbox® for your automotive sound system. With proper installation, your new vehicle-specific enclosed subwoofer system will deliver years of listening pleasure.

We strongly recommend that you have your new Stealthbox® installed by your authorized JL Audio dealer. The installation professionals employed by your dealer have the necessary tools and experience to disassemble and reassemble your vehicle properly. If you prefer to perform your own installation, please read this installation guide completely before beginning the process.

INCLUDED HARDWARE

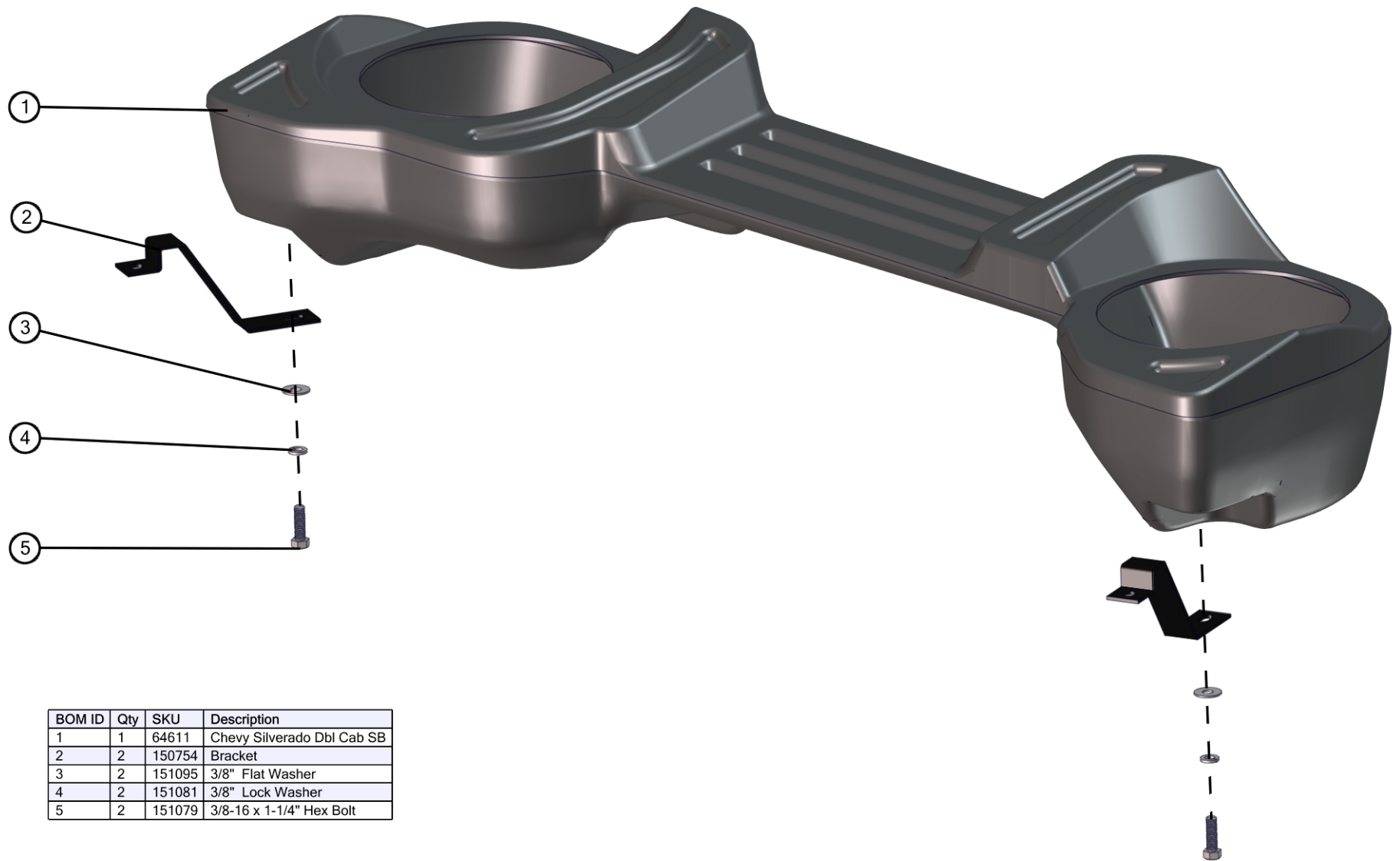

BOM ID	Qty	SKU	Description
1	1	64611	Chevy Silverado Dbl Cab SB
2	2	150754	Bracket
3	2	151095	3/8" Flat Washer
4	2	151081	3/8" Lock Washer
5	2	151079	3/8-16 x 1-1/4" Hex Bolt

POWER RECOMMENDATION

JL Audio recommends high quality amplifiers such as the JL Audio XD600/1v2. The diagram below shows the recommended crossover settings for the XD600/1v2. For a detailed description of the amplifier settings, consult the owner's manual for the amplifier. If another amplifier is being used, please reference this illustration and use similar settings on that amplifier.

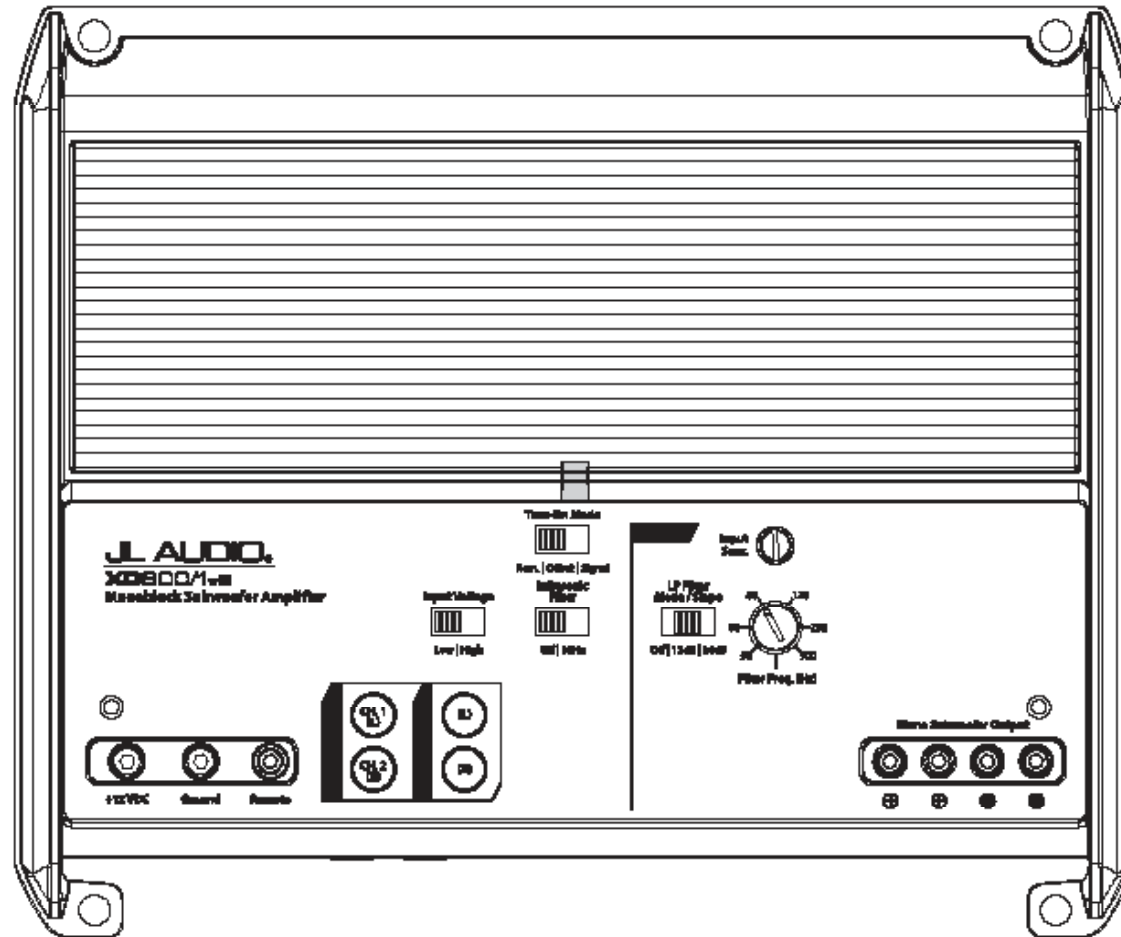

CONNECTIONS

Using quality power, signal, and speaker wire is essential in ensuring the performance of your Stealthbox®. JL Audio recommends using a 4 AWG power kit such as the XD-PCS4-1B for your Stealthbox® amplifier. Other kits are available should you be using more than one amplifier. Signal wire such as the JL Audio Premium Audio Interconnect Cables should be used to provide signal for both channels of the amplifier. JL Audio recommends using 12AWG speaker wire for subwoofers such as our XC-BCS12-25.

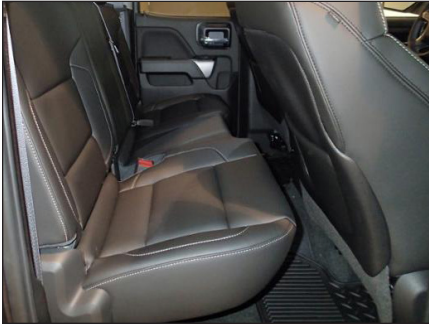

STEP 1

Empty out the rear seat area of the vehicle, and fold the rear seats up.



STEP 2

Remove the indicated factory nut on the driver's side, rear seat bracket.

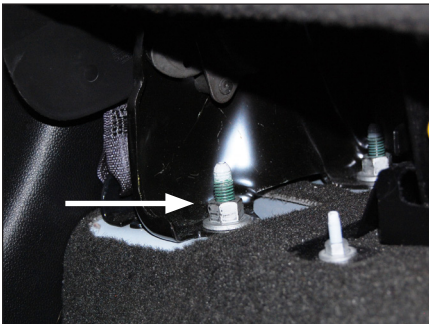

STEP 3

Remove the indicated factory nut on the passenger side, rear seat bracket.

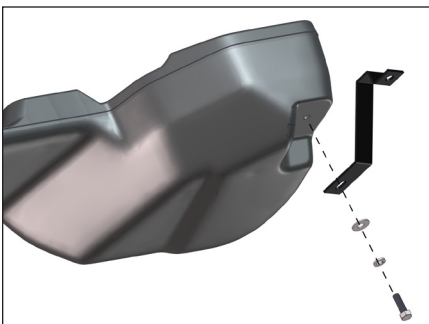

STEP 4

Locate the threaded inserts on the bottom of the enclosure. Slide a 3/8" Lock Washer and a 3/8" Flat Washer over a 3/8 - 16 x 1-1/4" Hex Bolt, thread the assembly through the slotted hole on a Bracket, into the threaded insert on the enclosure, and hand tighten.

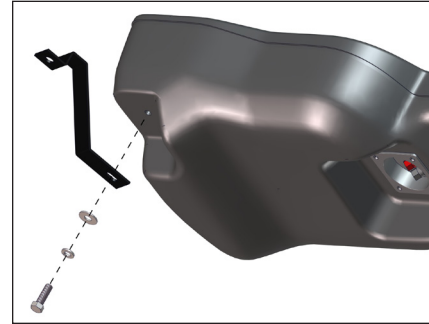

STEP 5

Repeat the process for the opposite side.

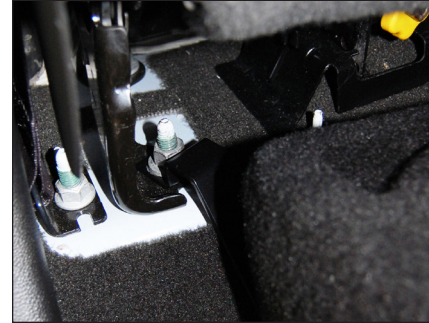

STEP 6

Connect speaker cable to the terminal cup on the bottom of the enclosure, and carefully place the Stealthbox® into position inside the vehicle, allowing the factory studs to pass through the holes in the Brackets. Reinstall the factory nuts on both sides, and fully tighten.



STEP 7

Fully tighten the 3/8 - 16 x 1-1/4" Hex Bolts on both sides.



STEP 8

Route the speaker cable as necessary, and fold the rear seats back down.

CONGRATULATIONS!

You have completed the installation for this model! Enjoy your new Stealthbox®!



MID/HIGH FREQUENCY DRIVER FITMENT

A variety of JL Audio coaxial and component systems will fit in the factory speaker locations of your vehicle.

Front Speaker Size / Location: 6 x 9" - Front Doors
Fits JL Audio Models: TR690-TXi & C2-690tx

Rear Speaker Size / Location: 5-1/4" - Rear Door
Fits JL Audio Models: TR525-CXi, C2-525, C2-525x, C3-525,
C5-525, C5-525x, & ZR525-CSi



JL AUDIO® | How we play.™    

(954) 443-1100

www.jlaudio.com

All specifications are subject to change without notice. "JL Audio"™ and the JL Audio logo, and "Stealthbox" and the Stealthbox logo are registered trademarks of JL Audio, Inc. "Ahead of the Curve", its respective logo, and "How we play" are trademarks of JL Audio, Inc.
Printed in USA • ©2016 JL Audio, Inc. • For more detailed information please visit us online at www.jlaudio.com.

JLA-SKU# 011396 • ver. 09.16.2016 • 10369 NORTH COMMERCE PARKWAY • MIRAMAR, FLORIDA • 33025 • USA