







ASSEMBLY INSTRUCTION

Item#:1618-25350-DKW Deconstructed Counter Stool

** Please make sure you have all parts indicated below prior to assembly.

NO	Hardware List		Q'ty
A		5/16" * 50MM BOLT	4
B		5/16" LOCK WASHER	8
C		5/16" FLAT WASHER	8
D		ALLEN WRENCH	1
E		SCREW	6
F		5/16" * 55MM BOLT	4

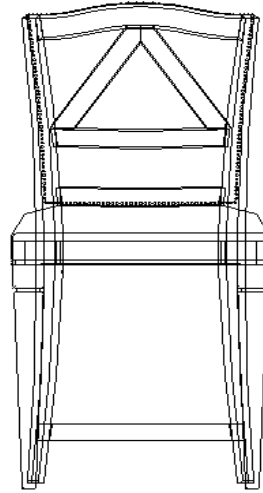

Assembly Steps:

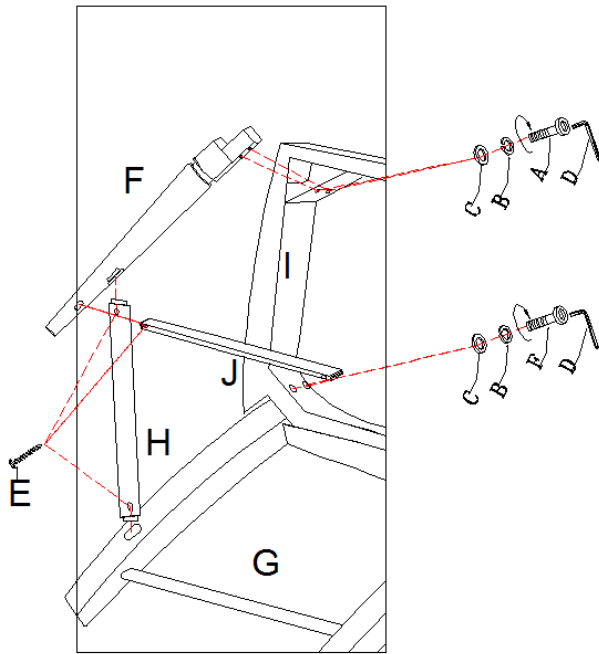

Diagram 1

Please follow numbers on front legs and letters on chair during assembly.

1. Place chair back on a clean surface.
2. Tighten seat frame (I) to chair back(G) and assemble back legs to the corner blocks of seat frame(I) by using 4 bolts (C), 4 lock washers (B) and 4 flat washers (A).
3. Assemble front left and right legs (F) according to the numbers to corner blocks of seat frame (I), using 2 bolts (C), 2 lock washers (B) and 2 flat washers (A).
4. Assemble back legs to corner blocks of seat frame (I), using 2 bolts (F), 2 lock washers (B) and 2 flat washers (A)
5. Screw the rail (H) on two sides and footrest (J) on front to legs.
6. Tighten all bolts and screws, turn the chair upright.
7. Level the chair following the "chair leveling instruction" as below.
8. Make sure the chair is level and then tighten all bolts completely by using allen wrench (D).

PLEASE READ THESE INSTRUCTIONS PRIOR TO ASSEMBLING THE CHAIRS CHAIR LEVELING INSTRUCTION SUPPLEMENT

Chair leveling procedures:

To make the assembly process easy and efficient, please read the entire instruction sheet prior to assembling the chair. Make sure all hardware listed is included. To properly assemble the chair, none of the bolts should be fully tightened until all components are attached to the chair. This will allow an opportunity to level the chair and prevent any unnecessary "rocking".

1. Place the loosely assembled chair on a hard flat surface.
2. Apply gentle downward pressure on the seat. This step eliminates rocking and ensures the chair to be level.
3. Once the chair is level, tighten all bolts and nuts.

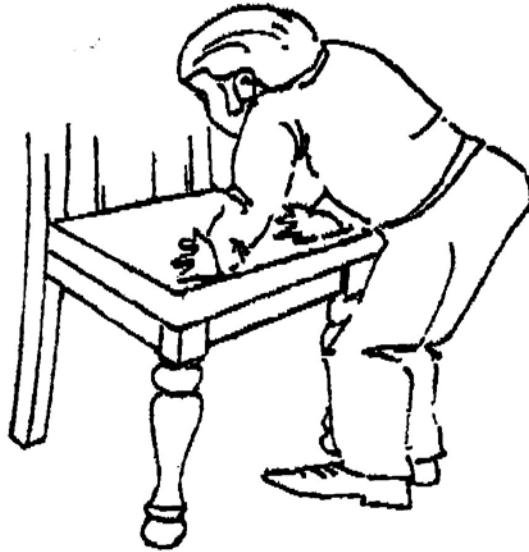

Note:

Most floors have slight irregularities that can affect chair leveling. If your chair is uneven when placed in its desired location, perform the following steps:

1. Loosen front legs to finger tight.
2. Extend both front legs upward to their fullest length.
3. Gently push downward on the front edge of the seat until all four legs rest on the floor.
4. Re-tighten all bolts and nuts.

Cleaning Instruction: Clean finished parts with a damp cloth using a mild dishwashing liquid and water solution. Polish the finish with soft cloth and an industry recognized furniture polish.