





ASSEMBLY INSTRUCTION

Item#:1610-75001-GRY Round Pedestal Dining Table Base
1610-75002-GRY 60in Round Pedestal Dining Table Top
1610-75003-GRY 72in Round Pedestal Dining Table Top

*** Please make sure you have all parts indicated below prior to assembly.
This unit is heavy and can best be assembled with the help of two or more people

NO.	HARDWARE LIST		Q'TY
A		ALLEN WRENCH	1
B		BOLT	4
C		LOCK WASHER	4
D		FLAT WASHER	4

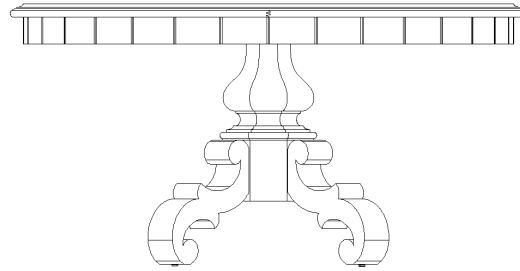

Assembly steps :

1. Place table top upside down on a soft surface to prevent it from being scratched.
(See diagram 1)
2. Attach base to top by using bolts (B), lock washers (C) and flat washers (D), secure with allen wrench (A) in clockwise direction.
(See diagram 2)

Caution: Do not over tighten.

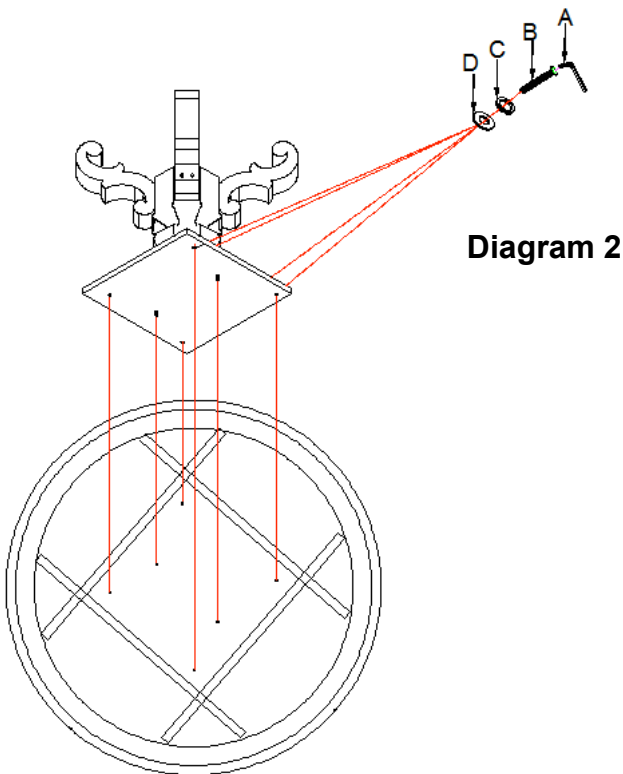

Diagram 2

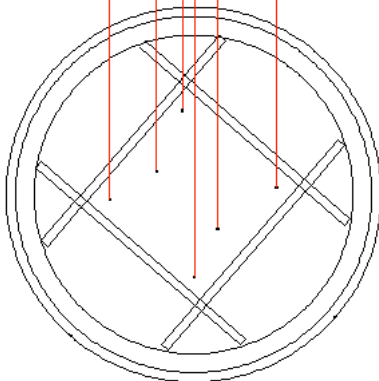

Diagram 1

*Cleaning Instruction: Clean finished parts with a mild dishwashing liquid and water solution on a damp cloth.
Polish the finish with soft cloth and an industry recognized furniture polish.*