









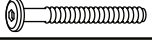
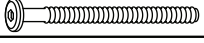

Examine all packaging material for small parts that may have come loose during shipment. Periodic checks are recommended to insure that all components are in proper position, tight and free from damage. Keep this assembly instruction for future reference. Adult assembly is required. The product of Hillsdale Furniture, LLC is designed for residential use only. Customer Service Phone Number: 502-562-0000 HDFKC

CODE	QTY	HARDWARE	
1	8	M8 x 20mm Bolts	
2	8	M6 x 25mm Bolts	
3	24	M6 x 35mm Bolts	
4	6	M6 x 50mm Bolts	
5	2	M6 x 100mm Bolts	
6	2	Wood Dowels	
7	30	M6 x 13mm Spring Washers	
8	30	M6 x 19mm Flat Washers	
9	8	M4 x 32mm Screws	
10	1	M5 x 65mm Allen Wrench	
11	1	M4 x 100mm Allen Wrench	

CODE	QTY	COMPONENTS	CODE	QTY	COMPONENTS
A	1	Headboard 	B	2	Headboard Legs 
C	1	Footboard 	D	2	Footboard Legs 
E	2	Left Side Rails 	F	2	Right Side Rails 
G	4	Side Rail Cleats 	H	2	Side Rail Support Legs 
I	4	Slats 	J	8	Support Legs with Adjustable Feet 

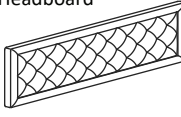
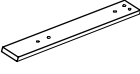
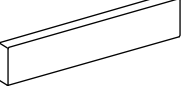
Unload hardware and components from behind of headboard.

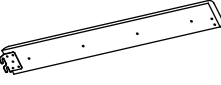
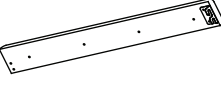
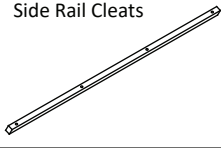
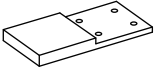
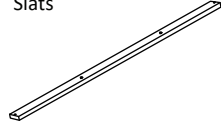
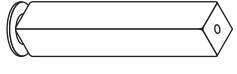
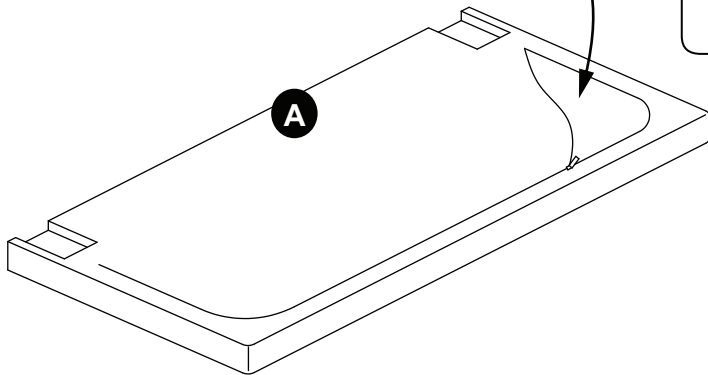

STEP 1 - Figure 1

Begin assembly by attaching each Headboard Leg (B) to Headboard (A) using 3 Allen Bolts (4), 3 Spring Washers (7) and 3 Flat Washers (8) per leg. Tighten bolts with Allen Wrench (11) provided.

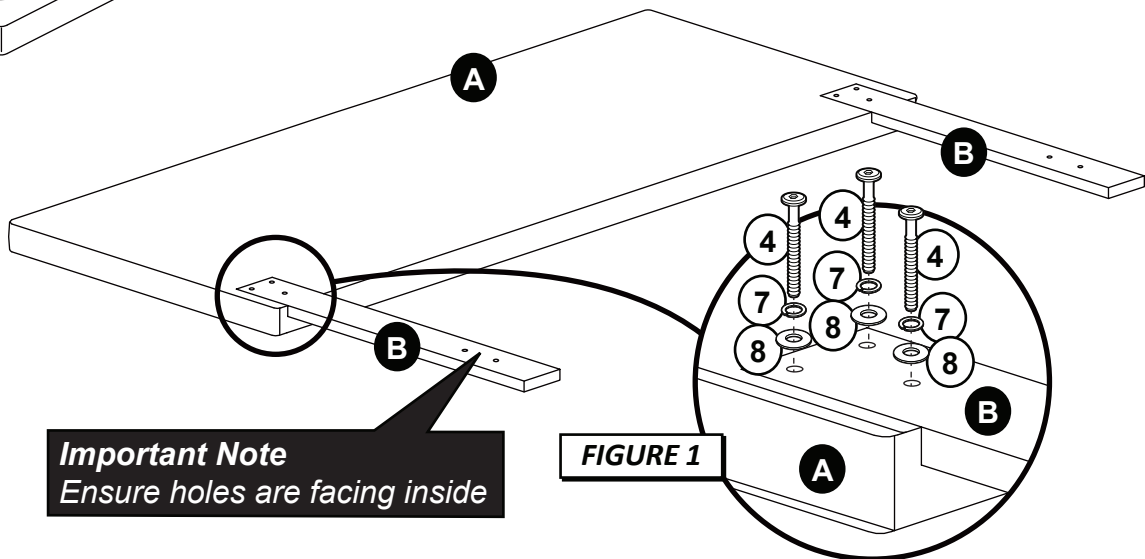

Important Note
Ensure holes are facing inside

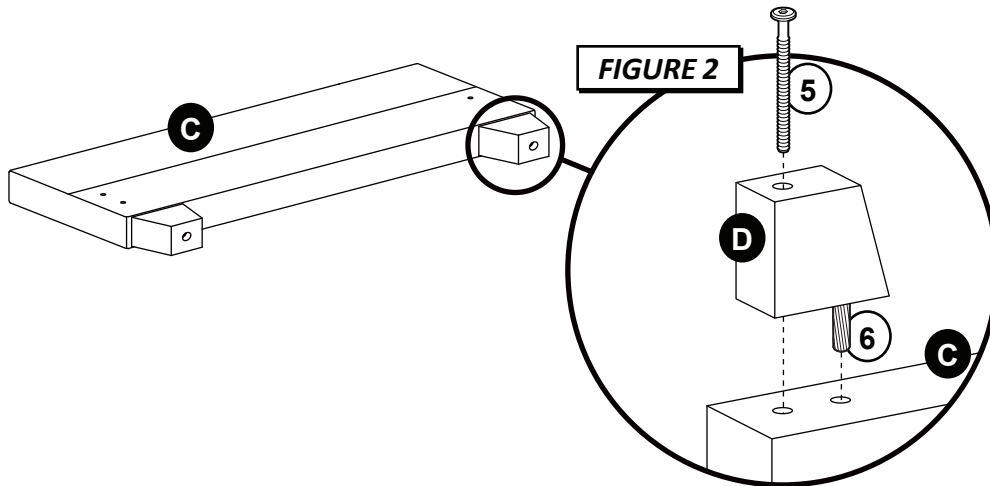

STEP 2 - Figure 2

Insert 1 wood dowel(6) to each Footboard leg (D) and attach to the Footboard(C) using 1 Allen Bolt(5) per leg. Tighten bolts with Allen Wrench (11) provided.

STEP 3 - Figure 3

Attach each Side Rail Cleat (G) to Left and Right Side Rails (E & F) using 4 Allen Bolts (3), 4 Spring Washers (7) and 4 Flat Washers (8) per cleat. Tighten bolts with Allen Wrench (11) provided.

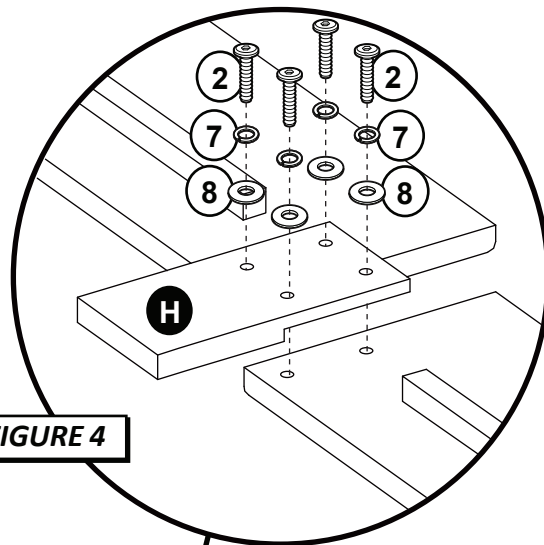
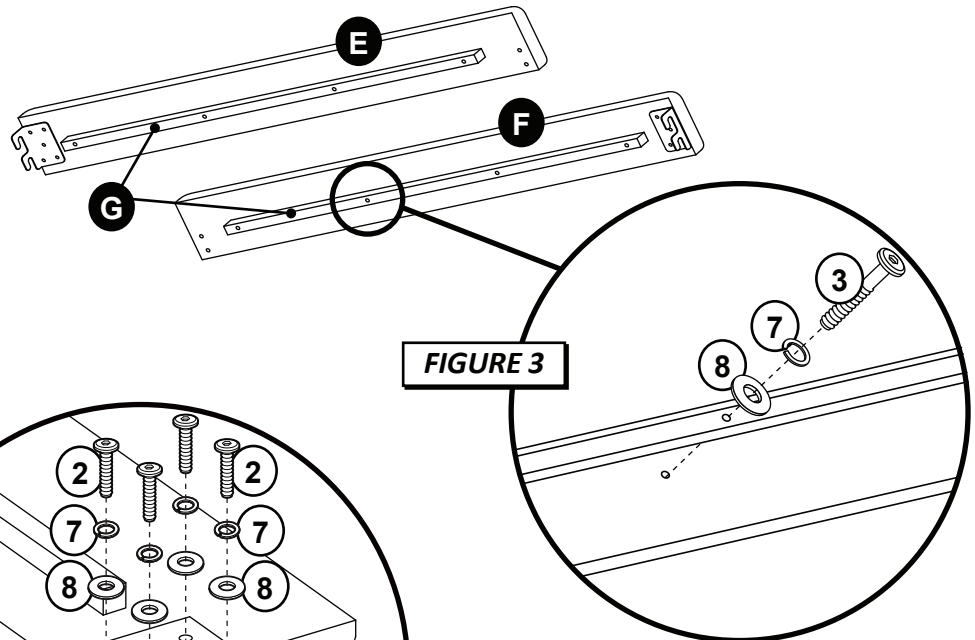

STEP 4 - Figure 4

Attach Right Side Rails (E & F) to each other by lining up the holes with those of the Side Rail Support Legs (H). Secure each one with 4 Allen Bolts (2), 4 Spring Washers (7) and 4 Flat Washers (8). Tighten bolts with Allen Wrench (11) provided.

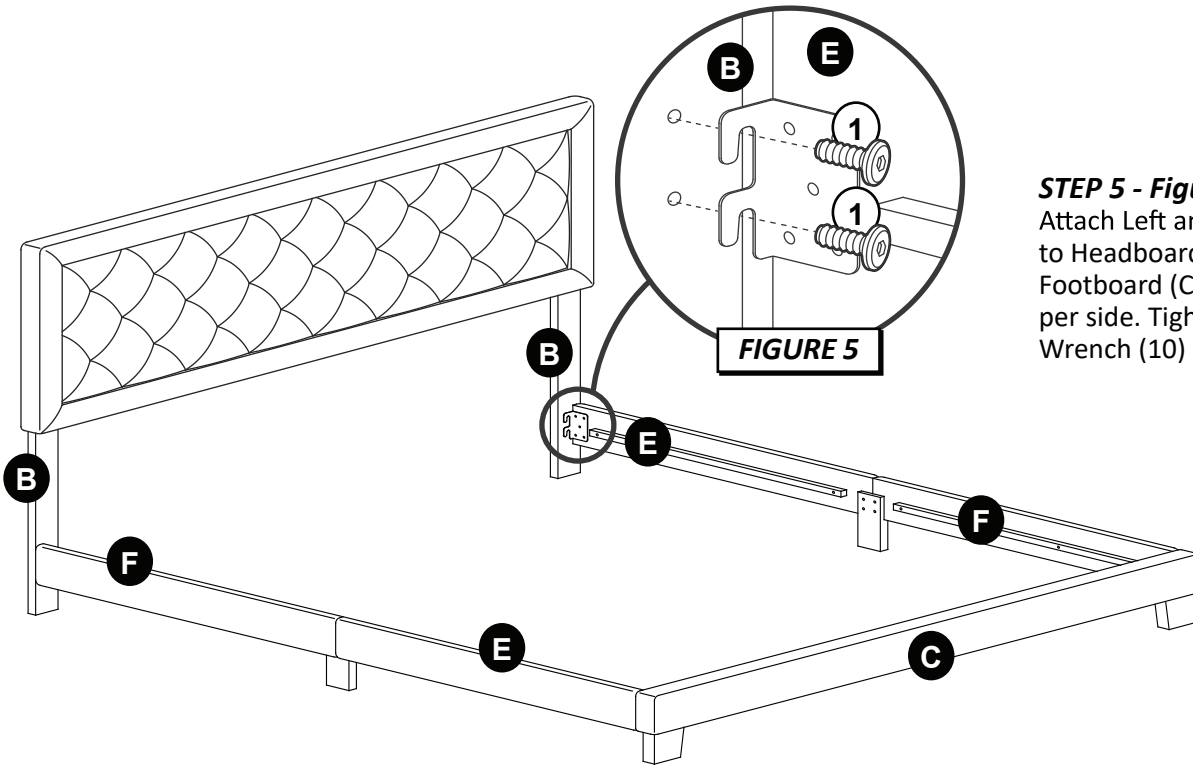

STEP 5 - Figure 5

Attach Left and Right Side Rails (E & F) to Headboard Legs (B) and to Footboard (C) using 2 Allen Bolts (1) per side. Tighten bolts with Allen Wrench (10) provided.

STEP 6 - Figure 6

Attach Support Legs (J) to Slats (I) using 1 Allen Bolt (3) per leg. Tighten bolts with Allen Wrench (11) provided.

STEP 7 - Figure 7

Place Slats (I) on the guidelines to the Side Rails (E & F) using 1 Screw (9) per side. Tighten screws with Phillips head screwdriver (not included).

