

Gaggenau

Use and care manual

CI 292 601

Cooktop

CI 292 601

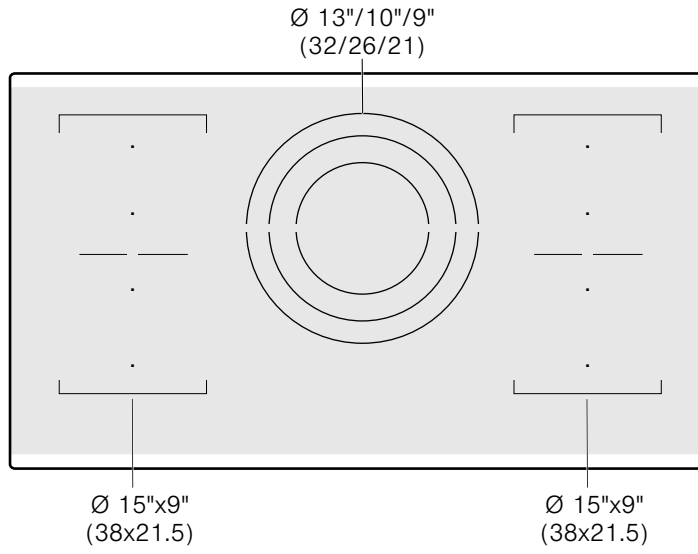

Table of Contents

▲ Safety Definitions	4	Booster function for saucepans	23
IMPORTANT SAFETY INSTRUCTIONS	5	Activating	23
Fire Safety	5	Deactivating	23
Cooking Safety	6	Booster function for frying pans	24
Burn Prevention	7	Recommendations for use	24
Child Safety	8	Activating	24
Cleaning Safety	9	Deactivating	24
Cookware Safety	9	Keep-warm function	25
Proper Installation and Maintenance	9	Activating	25
Electromagnetic interference	10	Deactivating	25
Cooling fan	11	Cooking assistance functions	25
Proposition 65 Warning	11	Cooking assistance function types	25
Causes of damage	12	Suitable cookware	26
Overview	12	Sensors and special accessories	27
Protecting the Environment	13	Functions and heat settings	27
Energy-saving Advice	13	Table	31
Cooking with Induction	13	Teppan Yaki for the Flex Zone	37
Advantages of induction cooking	13	Wireless cooking sensor	39
Cookware	13	Preparing and caring for the wireless cooking sensor	39
Getting to know your appliance	15	Connecting the wireless cooking sensor to the control panel	39
Control panel	15	Cleaning	40
Elements	16	Changing the battery	40
Residual heat indicator	16	Declaration of Conformity	41
Twistpad with Twist Knob	17	Childproof lock	42
Remove the twist knob	17	Activating and deactivating the childproof lock	42
Storing the twist knob	17	Display cleaning protection	42
Operating the appliance	17	Automatic shut-off	42
Switching the cooktop on and off	17	Basic settings	43
Setting an element	18	To access the basic settings:	44
Settings table	19	Home Connect	45
Flex function	20	Setting Up	45
Cookware use recommendations	20	Home Connect Settings	47
As two independent cooking zones	20	Software update	49
As a single cooking zone	20	Remote diagnostics	49
Transfer function	21	Information on Data Protection	49
Timer functions	22	Wi-Fi® Module	49
Cooking timer	22		
Short-term timer	22		
Stopwatch function	23		

Connecting an extractor hood	50
Setting up a connection	50
Resetting the connection	51
Controlling the hood via the cooktop	51
Hood control settings	52
Clean	53
Daily Cleaning	53
Cleaning guidelines	53
Cleaning chart	53
Twist knob	54
Maintenance	54
Frequently-asked questions and answers (FAQ)	54
Faults – what to do?	56
Cookware Test	57
Customer Service	58

Additional information on products, accessories, replacement parts and services can be found at www.gaggenau.com and in the online shop www.gaggenau.com/zz/store

Safety Definitions

WARNING

This indicates that death or serious injuries may occur as a result of non-observance of this warning.

CAUTION

This indicates that minor or moderate injuries may occur as a result of non-observance of this warning.

NOTICE

This indicates that damage to the appliance or property may occur as a result of non-compliance with this advisory.

Note: This alerts you to important information and/or tips.

IMPORTANT SAFETY INSTRUCTIONS

READ AND SAVE THESE INSTRUCTIONS

WARNING

When properly cared for, your new appliance has been designed to be safe and reliable. Read all instructions carefully before use. These precautions will reduce the risk of burns, electric shock, fire, and injury to persons. When using kitchen appliances, basic safety precautions must be followed, including those in the following pages.

Examine the appliance after unpacking it. In the event of transport damage, do not plug it in.

Fire Safety

Do not allow aluminum foil, plastic, paper or cloth to come in contact with a hot surface element, burner or grate. Do not allow pans to boil dry.

If the cooktop is near a window, forced air vent or fan, be certain that flammable materials such as window coverings do not blow over or near the burners or elements. They could catch on fire.

Always have a working smoke detector near the kitchen.

Never leave the cooktop unattended when in use. Boilovers cause smoking and greasy spillovers may ignite.

WARNING

TO REDUCE THE RISK OF A GREASE FIRE:

1. Never leave surface units unattended at high settings. Boilovers cause smoking and greasy spillovers that may ignite. Heat oils slowly on low or medium settings.
 2. Always turn hood ON when cooking at high heat or when flambéing food (i.e. Crepes Suzette, Cherries Jubilee, Peppercorn Beef Flambé).
 3. Clean ventilating fans frequently. Grease should not be allowed to accumulate on fan or filter.
 4. Use proper pan size. Always use cookware appropriate for the size of the surface element.
-

In the event that personal clothing or hair catches fire, drop and roll immediately to extinguish flames.

Have an appropriate fire extinguisher available, nearby, highly visible and easily accessible near the appliance.

Smother flames from food fires other than grease fires with baking soda. Never use water on cooking fires.



IMPORTANT SAFETY INSTRUCTIONS

READ AND SAVE THESE INSTRUCTIONS



WARNING

TO REDUCE THE RISK OF INJURY TO PERSONS IN THE EVENT OF A GREASE FIRE, OBSERVE THE FOLLOWING:

1. **SMOTHER FLAMES** with a close-fitting lid, cookie sheet, or metal tray, then turn off the burner. **BE CAREFUL TO PREVENT BURNS.** If the flames do not go out immediately, **EVACUATE AND CALL THE FIRE DEPARTMENT.**
 2. **NEVER PICK UP A FLAMING PAN** – You may be burned.
 3. **DO NOT USE WATER**, including wet dishcloths or towels – a violent steam explosion will result.
 4. Use an extinguisher **ONLY** if:
 - You know you have a Class ABC extinguisher, and you already know how to operate it.
 - The fire is small and contained in the area where it started.
 - The fire department is being called.
 - You can fight the fire with your back to an exit.
-

Whenever possible, do not operate the ventilation system during a cooktop fire. However, do not reach through fire to turn it off.

Cooking Safety



WARNING

Use this appliance only for its intended use as described in this manual. **NEVER** use this appliance as a space heater to heat or warm the room. Doing so may result in overheating the appliance. Never use the appliance for storage.

When using the timer, always supervise the cooktop and do not allow anything to boil over or burn. Boilovers can cause smoke and some foods and oils may catch fire if left on high temperature settings.



WARNING

If the frying sensor is not working properly, overheating may result causing smoke and damage to the pan.

WHEN COOKING WITH THE FRYING SENSOR OBSERVE THE FOLLOWING:

- Use a system pan only
 - Always put the pan in the center of the heating element
 - Do not place a lid on the pan
 - Never leave frying fat unattended
-



IMPORTANT SAFETY INSTRUCTIONS

READ AND SAVE THESE INSTRUCTIONS



CAUTION

If the temperature sensing system is not working properly, boilovers may result causing burns and injury.

WHEN COOKING WITH THE COOKING SENSOR FUNCTION OBSERVE THE FOLLOWING:

- Always put the lid on pots
 - Always fill pots with at least 1 ¼" (3 cm) of liquid
 - Always use pots of the appropriate size and type (enamelware pots, stainless steel and aluminum pots equipped with wireless temperature sensor)
 - Always keep the sensor's window clean
-



WARNING

Risk of injury!

The wireless temperature sensor is powered by a battery, which may become damaged if it is exposed to high temperatures. Remove the sensor from the cookware and store it away from any heat sources.



WARNING

Risk of injury!

The temperature sensor can be very hot when removing it after cooking. Use potholders or a dish towel to remove it.

burner where the cookware with temperature sensor is located.

Never use the appliance if liquids or foods have spilled around the control panel. Always turn off the cooktop and dry the control panel.

Injury and damage to the appliance may occur if control elements are not used properly.

If the cooktop turns off automatically and can no longer be operated, it may turn itself on unintentionally at a later point. Switch off the circuit breaker in the fuse box. Contact Customer Support for service.

Burn Prevention

DO NOT TOUCH SURFACE UNITS OR AREAS NEAR UNITS - Surface units may be hot even though they are dark in color. Areas near surface units may become hot enough to cause burns. During and after use, do not touch, or let clothing, potholders, or other flammable materials contact surface units or areas near units until they have had sufficient time to cool. Among these areas are the cooktop and areas facing the cooktop.

Do not heat or warm unopened food containers. Build-up of pressure may cause the container to burst and cause injury.

Always use dry potholders. Moist or damp potholders on hot surfaces may result in burns from steam. Do not let potholder touch hot heating elements. Do not use a towel or other bulky cloth.

With use of the cooking functions, make sure that the burner set matches the



IMPORTANT SAFETY INSTRUCTIONS

READ AND SAVE THESE INSTRUCTIONS

Always turn hood ON when cooking at high heat or when flambéing food (i.e. Crêpes Suzette, Cherries Jubilee, Peppercorn Beef Flambé).

Use high heat settings on the cooktop only when necessary. To avoid bubbling and splattering, heat oil slowly, on no more than a low-medium setting. Hot oil is capable of causing extreme burns and injury.

Never move a pan of hot oil, especially a deep fat fryer. Wait until it is cool.

Secure all loose garments, etc., before beginning. Tie long hair so that it does not hang loose, and do not wear loose-fitting clothing or hanging garments, such as ties, scarves, jewelry, or dangling sleeves.



WARNING

Risk of burns!

Metallic objects become hot very quickly on the cooktop. Never set down metallic objects such as knives, forks, spoons and lids on the cooktop.



WARNING

Risk of burns!

The pan detection shut-off feature may not turn off the cooking zone due to spilled food or objects placed on the cooktop.

If the display does not work when a cooking area is heating up, disconnect the circuit breaker or fuse in the electrical panel. Contact an authorized servicer.

Child Safety

When children become old enough to use the appliance, it is the responsibility of the parents or legal guardians to ensure that they are instructed in safe practices by qualified persons.

Do not allow anyone to climb, stand, lean, sit, or hang on any part of an appliance, especially a door, warming drawer, or storage drawer. This can damage the appliance, and the unit may tip over, potentially causing severe injury.

Do not allow children to use this appliance unless closely supervised by an adult. Children and pets should not be left alone or unattended in the area where the appliance is in use. They should never be allowed to play in its vicinity, whether or not the appliance is in use.



CAUTION

Items of interest to children should not be stored in an appliance, in cabinets above an appliance or on the backsplash. Children climbing on an appliance to reach items could be seriously injured.



IMPORTANT SAFETY INSTRUCTIONS

READ AND SAVE THESE INSTRUCTIONS

Cleaning Safety

Do not clean the appliance while it is still hot. Some cleaners produce noxious fumes when applied to a hot surface. Wet clothes and sponges can cause burns from steam.

Do not use steam cleaners to clean the appliance.

Cookware Safety

Hold the handle of the pan when stirring or turning food. This helps prevent spills and movement of the pan.

Use Proper Pan Size.

The use of undersized cookware will expose a portion of the heating element or burner to direct contact and may result in ignition of clothing. Select cookware having flat bottoms large enough to cover the surface heating unit. This appliance is equipped with one or more surface units of different sizes. Proper relationship of cookware to heating element or burner will also improve efficiency.

Cookware not approved for use with ceramic cooktops may break with sudden temperature changes. Use only pans that are appropriate for ceramic induction cooktops.

Always position handles of utensils inward so they do not extend over adjacent work areas, burners, or the edge of the cooktop. This reduces the risk of fires, spills and burns.



WARNING

RISK of injury!

When cooking with a double-boiler, the cooktop and cooking vessel may crack due to overheating. The cooking vessel in the double-boiler must not come in direct contact with the bottom of the pot filled with water. Use only heat-resistant cookware.



WARNING

Danger of injury!

Cookware may jump upward due to fluid trapped between the cookware bottom and cooking zone. Always keep cooking zone and cookware bottom dry.

Proper Installation and Maintenance

Have the installer show you the location of the circuit breaker or fuse. Mark it for easy reference.

This appliance must be properly installed and grounded by a qualified technician. Connect only to properly grounded outlet. Refer to Installation Instructions for details.

This appliance is intended for use up to a maximum height of 13,100 feet (4,000 meters) above sea level.

This appliance is intended for normal family household use only. It is not approved for outdoor use. See the Statement of Limited Product Warranty. If



IMPORTANT SAFETY INSTRUCTIONS

READ AND SAVE THESE INSTRUCTIONS

you have any questions, contact the manufacturer.

Do not store or use corrosive chemicals, vapors, flammables or nonfood products on or near this appliance. It is specifically designed for use when heating or cooking food. The use of corrosive chemicals in heating or cleaning will damage the appliance and could result in injury.

Do not operate this appliance if it is not working properly, or if it has been damaged. Contact an authorized servicer.

Do not cook on a broken cooktop. Cleaning solutions and spills may create a risk of electric shock.

Do not repair or replace any part of the appliance unless specifically recommended in this manual. Refer all servicing to a factory authorized service center.

To avoid electrical shock hazard, before servicing the appliance, switch power off at the service panel and lock the panel to prevent the power from being switched on accidentally.

Electromagnetic interference



WARNING

This induction cooktop generates and uses ISM frequency energy that heats cookware by using an electromagnetic field. It has been tested and complies with Part 18 of the FCC Rules for ISM equipment. This induction cooktop meets the FCC requirements to minimize interference with other devices in residential installation. Induction cooktops may cause interference with television or radio reception. If interference occurs, the user should try to correct the interference by:

- Relocating the receiving antenna of the radio or television.
- Increasing the distance between the cooktop and the receiver.
- Connecting the receiver into an outlet different than the cooktop.

It is the user's responsibility to correct any interference.



CAUTION

Persons with a pacemaker or similar medical device should exercise caution when standing near an induction cooktop while it is in use. Consult your doctor or the manufacturer of the pacemaker or similar medical device for additional information about its effects with electromagnetic fields from an induction cooktop.



IMPORTANT SAFETY INSTRUCTIONS

READ AND SAVE THESE INSTRUCTIONS



WARNING

Hazard due to magnetism!

The wireless temperature sensor is magnetic. The magnetic elements can damage electronic implants such as pacemakers or insulin pumps. People with electronic implants should therefore not put the temperature sensor in the pockets of their clothes and should maintain a minimum distance of 4" (10 cm) with respect to their pacemaker or similar medical device.

Proposition 65 Warning:

This product may contain a chemical known to the State of California, which can cause cancer or reproductive harm. Therefore, the packaging of your product may bear the following label as required by California:

STATE OF CALIFORNIA PROPOSITION 65 WARNING:



WARNING

Cancer and Reproductive Harm - www.P65Warnings.ca.gov

Cooling fan

The cooktop is equipped with a cooling fan on its underside. Should the cooktop lie above a drawer, there must be no objects or paper in it. They may be sucked in and compromise the cooling of the appliance or damage the fan.

There must be a minimum distance of $\frac{3}{4}$ " (20mm) between the content of the drawer and the fan input.

Causes of damage

NOTICE

- Rough pot and pan bases scratch the cooktop.
 - Never leave cookware cooking empty. This can cause damage.
 - Do not place hot pots or pans on the control panel, the displays or the cooktop surround. This can cause damage.
 - Damage can occur if hard or pointed objects fall on the cooktop.
 - Aluminum foil and plastic containers can melt and stick on hot burners. The use of oven protective foil on the cooktop is not recommended.
-

Overview

You will find the most frequently caused damage in the following table.

Damage	Cause	Remedy
Stains	Boiled-over food.	Remove boiled-over food immediately with a glass scraper.
	Unsuitable cleaning agent.	Only use cleaning agents that are suitable for this type of cooktop.
Scratches	Salt, sugar and sand.	Do not use the cooktop as a work surface or storage space.
	Cookware with rough bases scratch the cooktop.	Check the cookware.
Discoloration	Unsuitable cleaning agent.	Only use cleaning agents that are suitable for this type of cooktop.
	Pan abrasion.	Lift pots and pans when moving them.
Blisters	Sugar, food with a high sugar content.	Remove boiled-over food immediately with a glass scraper.

Protecting the Environment

Energy-saving Advice

- Place a lid on cookware. Cooking with an uncovered pan will result in a considerable increase in energy use. Use a glass lid to provide visibility and avoid having to lift the lid.
- Use cookware equipped with a solid, flat bottom. Curved pan bases increase energy consumption.
- The diameter of the pan base must match the size of the element. Note: The manufacturer normally indicates the pan's upper diameter. This is normally greater than the diameter of the pan's base.
- Choose cookware of a size suited to the amount of food you are going to cook. A large pan that is only half full will use a lot of energy.
- Use a small amount of water when cooking. This saves energy, and vegetables retain a larger percentage of their vitamins and minerals.
- Select the lowest power level to maintain cooking. If the power level is too high, energy is wasted.

Cooking with Induction

Advantages of induction cooking

Induction cooking is very different from traditional cooking methods, as heat builds up directly in the item of cookware. This offers numerous advantages:

- Saves time when boiling and frying.
- Saves energy.
- Easier to care for and clean. Spilled food does not burn on as quickly.
- Heat control and safety – the cooktop increases or decreases the heat supply as soon as the user changes the setting. The induction element stops the heat supply as soon as the cookware is removed from the element, without having to switch it off first.

Cookware

Only use ferromagnetic cookware for induction cooking, such as:

- Cookware made from enameled steel
- Cookware made from cast iron
- Special induction-compatible cookware made from stainless steel.

To check whether your cookware is suitable for induction cooking, refer to the section on.

To achieve a good cooking result, the ferromagnetic area on the base of the pan should match the size of the element. If an element does not detect an item of cookware, try placing it on another element with a smaller diameter.

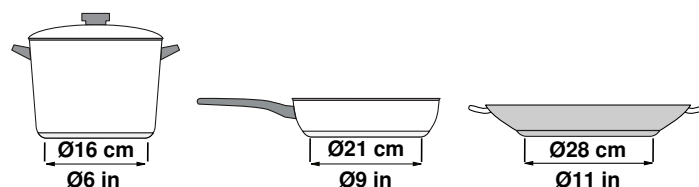

If the only element being used is the flexible cooking zone, larger cookware that is particularly suited to this zone can be used. You can read more information on the positioning of the cookware here → *"Flex function"*



Some induction cookware does not have a fully ferromagnetic base:

- If the base of the cookware is only partially ferromagnetic, only the area that is ferromagnetic will heat up. This may mean that heat will not be distributed evenly. The non-ferromagnetic area may not heat up to a sufficient temperature for cooking.

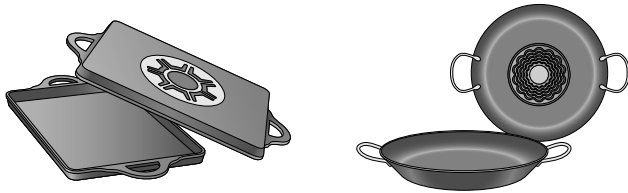

- The ferromagnetic area will also be reduced if the material of which the base of the cookware is made contains aluminum, for example. This may mean that the cookware will not become sufficiently hot or even that it will not be detected.

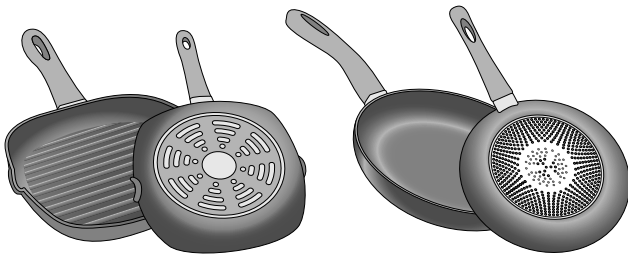

Unsuitable cookware

Do not ever use adapter plates for induction or cookware made of:

- Traditional stainless steel
- Glass
- Clay
- Copper
- Aluminum

Properties of the base of the cookware

The material(s) of which the base of the cookware is made can affect the cooking result. Using pots and pans made from materials that distribute heat evenly through them, such as stainless-steel pans with a three-layer base, saves time and energy.

Use cookware with a flat base; if the base of the cookware is uneven, this may impair the heat supply.

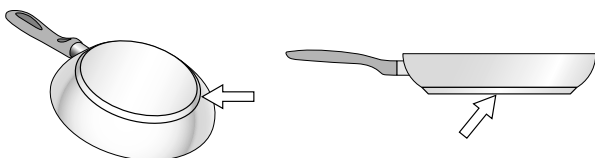

No pan or improper size

If no pan is placed on the selected element, or if it is made of unsuitable material or is not the correct size, the power level displayed on the element indicator will flash. Place a suitable pan on the element to stop the flashing. If you take longer than 90 seconds to place a suitable pan on the element, it will automatically turn off.

Empty pans or pans with a thin base

Do not heat up empty pans, or use pans with a thin base. The cooktop is equipped with an internal safety system. However, an empty pan may heat up so quickly that the "automatic shut-off" function may not have time to react, and the pan may reach very high temperatures. The pan base could melt and damage the cooktop glass. In this case, do not touch the pan and switch the cooktop off. If the cooktop fails to work after it has cooled down, please contact Customer Support.

Pan detection

Each element has a lower limit for pan detection. This depends on the diameter of the ferromagnetic area of the cookware and the material of which its base is made. For this reason, you should always use the element that best matches the diameter of the base of the pan.

Automatic detection in double and triple cooking zones

These cooking zones can detect cookware of different sizes. Depending on the material and the properties of the cookware, the cooking zone automatically activates the single, double or triple cooking zone, supplying the proper power to obtain good cooking results.

Getting to know your appliance

Page 2 contains a list of models and dimensions.

Note: Depending on the appliance model, individual details and colors may differ.

Control panel

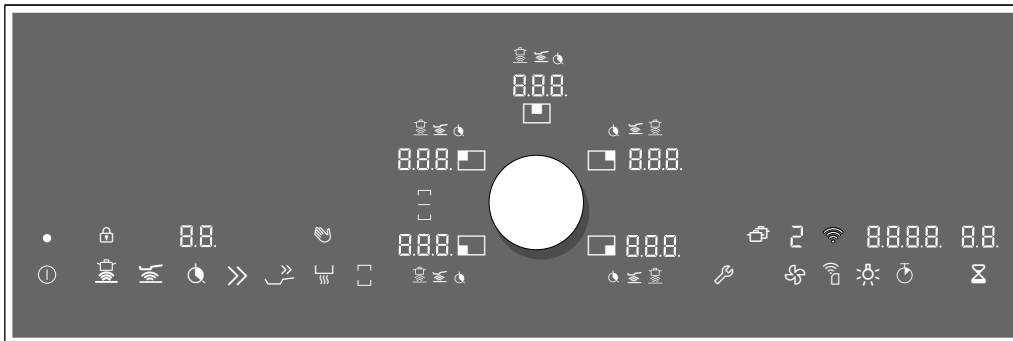

Selection sensors

	Main switch
	Cooking sensor
	Frying sensor technology for pans
	Timer function
	Booster function for pots
	Booster function for pans
	Keep-warm function
	Flex function
	Basic settings
	Hood control
	Home Connect – confirm setting
	Extractor hood lighting
	Stopwatch
	Timer

Displays

	Operating status
	Cooking zones
	Power levels
	Cooking sensor
	Frying sensor technology for pans
	Cooking timer
	Booster function for pots
	Booster function for pans
	Keep-warm function
	Residual heat
	Home network

Displays

	Fan settings
	Transfer function
	Timer
	Stopwatch
	Display cleaning protection
	Childproof lock
	Flex function activated
	Flex function deactivated
	Transfer function

Touch keys

When the cooktop heats up, the symbols for the touch keys available at this time light up.

Touching a symbol activates the associated function. A confirmation signal sounds.



Notes

- The corresponding symbols for the touch keys light up depending on whether they are available.

The indicators for the available functions light up in white. Once a function is selected, its indicator lights up in orange.

- Always keep the control panel clean and dry. Moisture can prevent it from working properly.
- Do not pull cookware close to the displays and sensors. The electronics could overheat.

Elements

Cooking zones		
	Single cooking zone	Use cookware that is a suitable size.
	Three-ring cooking zone	This ring switches on automatically when you use cookware with a base that covers the outer zone (☉ or ☉).
	FlexZone	See the section entitled → " <i>Flex function</i> "

Only use cookware suitable for induction cooking; see section

Residual heat indicator

The cooktop has a residual heat indicator for each cooking zone. This indicates that a cooking zone is still hot. Do not touch a cooking zone while the residual heat indicator is lit up.

The following indicators are shown depending on the amount of residual heat:

- Display *H*: High temperature
- Display *h*: Low temperature

If you remove the cookware from the cooking zone during cooking, the residual heat indicator and the selected heat setting will flash alternately.

When the cooking zone is switched off, the residual heat indicator will light up. Even after the cooktop has been switched off, the residual heat indicator will stay lit for as long as the cooking zone is still warm.

Twistpad with Twist Knob

The twistpad is the area in which you can use the twist knob to select the cooking zones and heat settings. The twist knob automatically centers itself in the twistpad area.

The twist knob is magnetic and is placed on top of the twistpad. To activate a cooking zone, press the twist knob so that it tilts in the appropriate area for the required cooking zone. Turning the twist knob selects the heat setting.

Position the twist knob on the twist pad so that it is in the center of the indicators that delimit the twist pad area.

Note: Even if the twist knob is not entirely central, this will not under any circumstances affect how the twist knob works.

Remove the twist knob

Removing the twist knob activates the wipe-protection function.

The twist knob can be removed during cooking. The wipe-protection function is activated for 10 minutes. If the twist knob is not returned to its position before this time elapses, the cooktop switches off.

WARNING

Risk of fire!

If during these 10 minutes a metallic object is placed in the twistpad area, the cooktop may continue to heat up. Therefore, always switch off the cooktop using the main switch.

Storing the twist knob

A strong magnet is located inside of the twist knob. Keep the twist knob away from magnetic data carriers such as credit cards and cards with magnetic strips. Otherwise, these data carriers may be damaged beyond repair.

The magnet may also cause faults on televisions and screens.



Note: The twist knob is magnetic. Metal particles stuck to the bottom may scratch the surface of the cooktop. Always clean the twist knob thoroughly.



Operating the appliance

This chapter explains how to set a cooking position. The table shows heat settings and cooking times for various meals.

Switching the cooktop on and off

Use the main switch to switch the cooktop on and off.

When you first switch on the appliance, you will be prompted to set up your home network. The  symbol will be lit dimly for a few seconds on the display panel. To begin setting up the connection, touch the  sensor and proceed in accordance with the information given in the section entitled → *"Home Connect" on page 45*. To exit initial set-up, touch any sensor.

To switch on: Position the twist knob in the area in which it can be used. Touch the  symbol. The symbols for the cooking zones and the functions available at this time light up.  lights up next to the cooking zones. The cooktop is ready for use.

To switch off: Touch the  symbol until the display goes out. All cooking zones are switched off. The residual heat indicator remains lit until the cooking zones have cooled down sufficiently.

Notes

- If the appliance has not been connected to your home network or the connection has been broken, network connection initial set-up will be activated whenever you switch on the cooktop.
- The cooktop switches off automatically if all cooking zones have been switched off for more than 20 seconds.
- The selected settings are stored for five seconds after the cooktop has been switched off. If the cooktop is switched back on during this period, the previously set heating settings flash. To apply these settings, tap on the twist knob within the next five seconds. If you do not tap the twist knob or if you touch a different sensor key, all previous settings will be deleted.

Setting an element

Set the required element using the twist knob.

Heat setting 1 = lowest setting.

Heat setting 9 = highest setting.

Every heat setting has an intermediate setting. This is shown in the element display as **.5**.

Notes

- To protect the fragile parts of your appliance from overheating and electrical overloading, the cooktop may temporarily reduce the power automatically.
- In order to prevent the appliance from producing excess noise, the cooktop may temporarily reduce the power automatically.

Selecting a cooking position and power level

The cooktop must be switched on.

1. Select the element. To do this, touch the twist knob in the appropriate area for the required element.
2. Within the next 10 seconds, turn the twist knob until the required heat setting appears in the heat setting display.

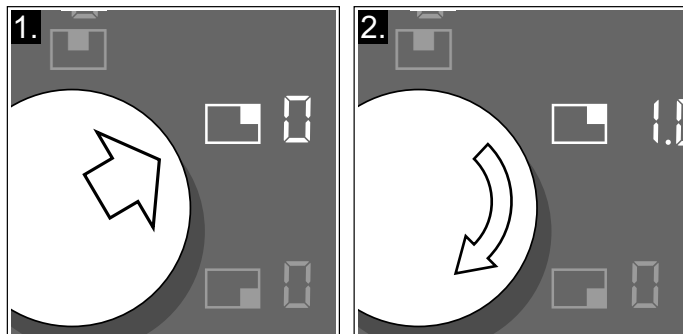

The power level is set.

Notes

- When placing an item of cookware on the flexible cooking zone, it must be positioned correctly according to size, see section → *"Flex function"*.

The cookware is detected and the element is selected automatically. You can change the settings.

- If the indicators flash after you have changed the settings, check whether the cookware is suitable for induction cooking. See section → *"Cookware Test"*

Changing the heat setting

Select the element and change the heat setting using the twist knob.

Switching off the element

Select the element and turn the twist knob until  appears. The element switches itself off and the residual heat indicator lights up.

Notes

- If there is no cookware on the induction element, the heat setting display flashes. After a while, the element will switch itself off.
- If there is cookware on the element before switching the cooktop on, this is detected at most 20 seconds after touching the main switch and the element is selected automatically. Set the heating setting within 10 seconds. Otherwise, the element switches off again after 20 seconds.

Even if there are several pots and pans on the cooktop when it is switched on, only one item of cookware is detected.

Settings table

The following table provides some examples. Cooking times may vary depending on the type of food, its weight and quality. Deviations are therefore possible.



CAUTION

During cooking, stews or liquids, such as soups, sauces or drinks can heat up very quickly and overflow or spatter. For this reason, we recommend that you stir continuously, gradually heating the food at a suitable power level.

	Power levels
Melting	
chocolate	1.5
butter	1.0 - 2.0
Heating	
frozen vegetables, e.g. spinach	2.5 - 3.5
broth	7.0 - 8.0
thick soup	1.5 - 2.5
milk**	1.0 - 2.0
Simmering	
delicate sauce e.g. Béchamel sauce	4.0 - 5.0
spaghetti sauce	2.0 - 3.0
pot roast	4.0 - 5.0
fish**	4.0 - 5.0
Cooking	
rice (with double amount of water)	2.0 - 3.0
potatoes boiled in their skins (with 1-2 cups of water)	4.0 - 5.0
boiled potatoes (with 1-2 cups of water)	4.0 - 5.0
fresh vegetables (with 1-2 cups of water)	2.0 - 3.5
frozen vegetables (with 1-2 cups of water)	3.5 - 4.5
pasta (with 2-4 qt. water)*	6.0 - 7.0
pudding**	1.0 - 2.0
cereals	2.0 - 3.0
Frying	
pork chop	5.5 - 6.5
chicken breast	5.0 - 6.0
bacon	6.0 - 7.0
eggs	5.0 - 6.0
fish	5.0 - 6.0
pancakes	6.0 - 7.0
Deep fat frying** (in 1-2 qt. oil)	
deepfrozen foods, e.g. chicken nuggets (0.5 lb per serving)	8.0 - 9.0
other, e.g. doughnuts (0.5 lb per serving)	4.5 - 5.5
Keep warm	
tomato sauce	1.5

* ongoing cooking without lid

** without lid

Flex function

You can use the flexible cooking zone as an individual element or as two independent elements, as required.

It consists of four inductors that work independently of each other. If the flex function is in use, only the area that is covered by cookware is activated.

Cookware use recommendations

Place the cookware in the middle. This assures optimal pot detection and heat distribution.

As a single element

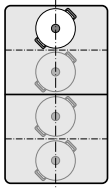

Diameter smaller than or equal to 5 1/8" (13 cm)
Place the cookware on one of the four positions that can be seen in the illustration.

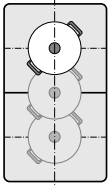

Diameter greater than 5 1/8" (13 cm)
Place the cookware on one of the three positions that can be seen in the illustration.

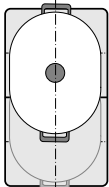

If the cookware takes up more than one element, place it starting on the upper or lower edge of the flexible cooking zone.

As two independent elements

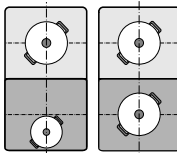



The front and rear elements each have two inductors and can be used independently of each other. Select the required heat setting for each of the elements. Use only one item of cookware on each element.

As a single cooking zone

Using the entire cooking zone by connecting both individual zones.

Linking the two elements

1. Set down the cookware. Select one of the two elements in the flexible cooking zone and set the heat setting.
2. Touch the  symbol. The  indicator lights up in the cooking zone area.

The flexible cooking zone has now been activated. The heat setting appears in the two displays for the flexible cooking zone.



Notes

- If both elements are set to different heat settings before being linked, both elements switch to 0 on activation.
- If there is a cooking timer programmed for one element, this will also be assigned to the second element when the two are linked.

Changing the heat setting

Select one of the two elements assigned to the flexible cooking zone and set the heat setting using the twist knob.

Disconnecting the two cooking zones

1. Select one of the two cooking zones assigned to the Flex Zone.
2. Touch the  symbol.
3. The  symbol appears in the cooking zone display.

The Flex function has been deactivated. The two cooking zones now operate independently of one another.

Note: If the element is switched off, and then switched back on again later, the flexible cooking zone is reset to function as two independent elements.

As two independent cooking zones

The flexible cooking zone is used like two independent cooking zones.

Activating

See section → "Operating the appliance"

Transfer function

You can use this function to transfer the power level, set cooking time and selected cooking function from one cooking zone to another.

To transfer the settings, move the cookware from the cooking zone that is switched on to another cooking zone.

This function can also be used on the flexible cooking zones.

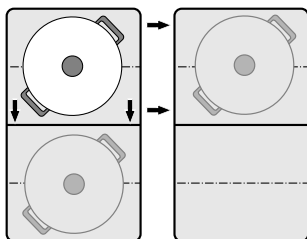

Note: For additional information on how to position the cookware please read section → "Flex function"

1. Lift the cookware from the cooktop.

The element indicator starts flashing. The element does not heat up.

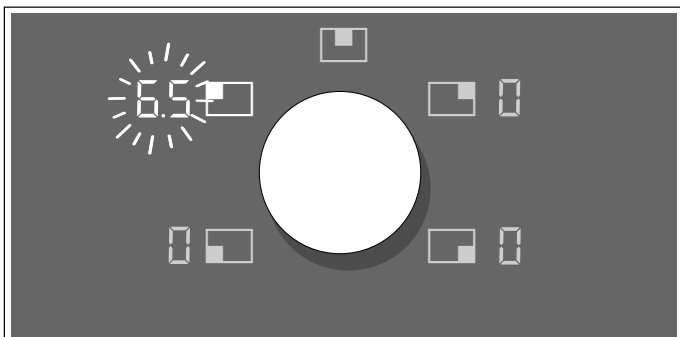

2. Set down the cookware on a flexible element within 90 seconds. The new element is detected and the  symbol lights up. The adopted heat setting flashes in the element display.

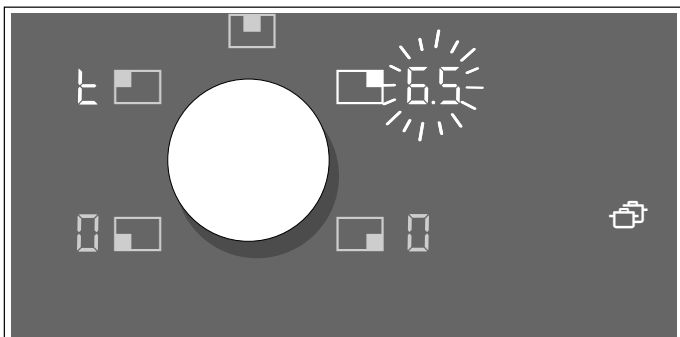

3. Select the new element within 90 seconds using the twist knob. The setting has been transferred.

Notes

- Move the cookware to a cooking zone that is not switched on, that you have not yet preset or on which no other cookware has been placed previously.
- If the Flex function is activated by moving an item of cookware across the flexible cooking zone, the settings are automatically applied.
- The booster functions can only be moved from left to right or from right to left when none of the cooking zones are active.
- If a new item of cookware is set down on a different cooking zone before the settings have been confirmed, this function will be ready for both cooking vessels. Confirm the required cooking zone.
- If you move more than one item of cookware, the function is only ready to use for the item of cookware that was last moved.
- When you place the cookware back in this position, the same settings are used.

Timer functions

Your cooktop has three timer functions:



- Cooking timer
- Short-term timer
- Stopwatch function

Cooking timer

The element automatically switches off after the time that is set has elapsed.

You can set a time of up to 99 minutes. The time elapses in the timer display in minutes, the final half a minute is displayed in seconds.

Setting procedure:

1. Select the element and the required heat setting.
2. Touch the  symbol. The  display for the element lights up.  lights up on the timer display.



3. Use the Twist knob to select the required cooking time.



The cooking time begins to elapse.

Note: If the flexible cooking zone is selected as the only element, the set time for the entire cooking zone is the same.

Frying sensor technology for frying pans/cooking sensor



If you set a cooking time for a cooking zone with activated frying sensor technology or activated cooking sensor, the cooking time begins to count down immediately and not just once the selected temperature level has been reached.

Changing or deleting the time

Select the element and then touch the  symbol.

Change the cooking time using the twist knob, or set to  to delete it.

When the time has elapsed

The element switches off. A signal sounds,  appears in the element display and  flashes in the timer display. Touch any symbol or press the twist knob; the indicators go out and the audible signal ceases.

Notes



- If a cooking time was programmed for several elements, the cooking time that ends first appears in the timer display. The  indicator for the element lights up orange.
- Select the relevant element to call up the remaining cooking time for a element. The cooking time appears for 10 seconds.

Short-term timer

You can use the short-term timer to set a time of up to 99 minutes.



This works independently from the elements and from other settings. This function does not automatically switch off a element.

How to activate the function



1. Touch the  symbol,  appears in the short-term timer display.
2. Select the required time using the twist knob.
3. Touch the  symbol again to confirm the selected time.

The time begins to elapse.

Changing or deleting the time

Touch the  symbol and use the twist knob to change the time or set it to .

When the time has elapsed

A signal sounds for three minutes.  flashes in the timer display. Touch the  symbol again: The displays go out and the audible signal ceases.

Timer plus

If you press and hold the ⌘ symbol for a few seconds before the audible signal ceases, the stopwatch is activated.

The display for the stopwatch shows the elapsed time since the end of the set timer time. The time that was previously set flashes in the timer display.

Press and hold the ⌘ symbol for a few seconds. This stops the stopwatch, and the displays go out.

The function has now been deactivated.

Stopwatch function

The stopwatch shows the cooking time that has elapsed so far in minutes and seconds (mm.ss). The maximum duration is 99 minutes and 59 seconds (99.59). If this value is reached, the display starts again at 00.00.

The stopwatch works independently of the elements and other settings. This function does not automatically switch off an element.

Activating

Touch the ⏸ symbol. 00.00 appears in the stopwatch display.

The time begins to elapse.

Deactivating

Touching the ⏸ symbol stops the stopwatch function. The stopwatch displays remain lit.

If you press the ⏸ symbol again while it is still orange, the time continues to elapse.

If you press and hold the ⏸ symbol, the displays go out.

The function is deactivated.

Booster function for saucepans

This function allows large volumes of water to be heated up even more quickly than with power setting 9. The Booster function temporarily increases the top output of the selected element.

This function can be activated for an element at any time, provided the other element in the same group is not in use (see illustration).

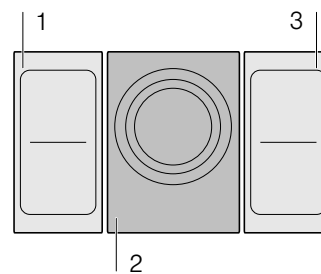

Note: The Booster function can also be activated on the flexible cooking zone if this is being used as a single element.

Activating

1. Select the element.
2. Touch the >> symbol.

The P indicator lights up.

The function has now been activated.

Deactivating

1. Select the element.
2. Touch the >> symbol, turn the twist knob or select a different function.

The P indicator goes out and the element switches back to the 9 heat setting.

The function is deactivated.

Notes

- In certain circumstances, this function may switch itself off automatically in order to protect the electronic elements inside the cooktop.
- If a heat setting had been made before activating the function, it is once again adopted automatically after deactivating the function.

Booster function for frying pans

This function enables you to heat cookware faster than when using heat setting 9.

After deactivating the function, select the appropriate heat setting for your food.

This function can be activated for an element at any time, provided the other element in the same group is not in use (see illustration).

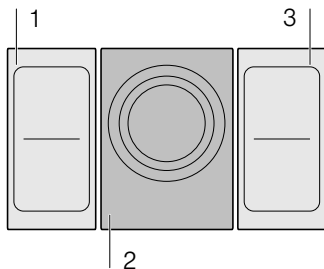

Note: The Booster function for pans can also be activated on the flexible cooking zone if this is being used as a single element.

Recommendations for use

- Always use cookware that has not been pre-heated.
- Use pots and pans with a flat base. Do not use containers with a thin base.
- Never leave empty cookware, oil, butter or lard to heat up unattended.
- Do not place a lid on the cookware.
- Place the cookware on the center of the element. Ensure that the diameter of the base of the cookware corresponds to the size of the element.
- You can find information on the type, size and positioning of the cookware in section → "Cooking with Induction"

Activating

1. Select the element.
2. Touch the  symbol. The **b** indicator lights up. The function has now been activated.

Deactivating

1. Select the element.
2. Touch the  symbol, turn the twist knob or select a different function. The **b** display goes out. The heat setting 9 lights up in the display for the element. The function is deactivated.



Notes

- After 30 seconds, this function will automatically switch itself off.
- If a power level was set before activating the function, this is automatically applied again after deactivating the function.

Keep-warm function



This function is suitable for melting chocolate or butter and for keeping food warm.

Activating

1. Select the required element.
2. Touch the  symbol within the next 10 seconds.
 lights up on the display.

The function has now been activated.

Deactivating

1. Select the element.
2. Press the  symbol, turn the twist knob or select a different function.
The  indicator goes out. The element switches itself off and the residual heat indicator lights up.

The function is deactivated.

Cooking assistance functions

The cooking assistance functions are guaranteed to make cooking easier and promise outstanding cooking results. The recommended temperature settings are suitable for any type of cooking.

They enable you to cook without using excessive heat and promise the perfect cooking and frying results.

The sensors measure the temperature of the cookware continuously. This allows the cooking power to be regulated so that the right temperature is maintained at all times.

You can add your food once the selected temperature has been reached. The temperature is automatically kept constant without you having to change the temperature setting.

This function exists for all cooking zones.

If a wireless cooking sensor is available, the cooking functions are available for all cooking zones.









This section contains information about the following:

- Cooking assistance function types
- Suitable cookware
- Sensors and optional accessories
- Functions and heat settings
- Recommended dishes

Cooking assistance function types

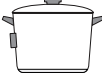

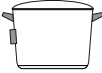





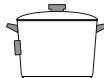

You can use the cooking assistance functions to select the best cooking type for each kind of food.

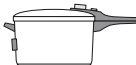
The table shows the various function settings that are available for the cooking assistants:

Cooking processes	Temperature levels °F (°C)	Cookware	Availability	Activating
Frying sensor technology for frying pans				
Frying with a little oil	1, 2, 3, 4, 5		All cooking zones	
Cooking sensor				
Keeping warm, heating	160 (70)		All cooking zones	
Poaching in milk	185 (85)		All cooking zones	
Poaching in water	195 (90)		All cooking zones	

*Preheat with the lid on and fry with the lid off.

If the cooktop does not have a wireless cooking sensor, you can purchase one from specialist retailers, Customer Service or our official website.

Cooking processes	Temperature levels °F (°C)	Cookware	Availability	Activating
Cooking	212 (100)		All cooking zones	
Cooking in a pressure cooker	240 (115)		All cooking zones	
Deep-fat frying at a low temperature	320 (160)		All cooking zones	
Deep-fat frying at a medium temperature	340 (170)		All cooking zones	
Deep-fat frying at a high temperature	355 (180)		All cooking zones	

*Preheat with the lid on and fry with the lid off.

If the cooktop does not have a wireless cooking sensor, you can purchase one from specialist retailers, Customer Service or our official website.

Suitable cookware

Select the cooking zone with the diameter that most closely matches that of the base of the cookware and place the cookware in the center of this cooking zone.

For the cooking functions, use cookware that is tall enough that, when the required volume of water is added, the water level is higher than the silicone patch for the wireless sensor.

Optimized frying pans and accessories are available for the frying sensor technology. These can be purchased from specialist retailers or through our technical customer service or our official website. Always quote the relevant reference number:

- **GP900001** 6" (15 cm) frying pan.
- **GP900002** 7" (18 cm) frying pan.
- **GP900003** 9" (21 cm) frying pan.
- **GP900004** 11" (28 cm) frying pan. Only recommended for the single 11" (28 cm) cooking zone.
- **CA051300** Teppan Yaki. Recommended for the flexible cooking zone only.

Notes

- The frying sensor for frying pans is specially optimized for this type and size of frying pan and are ideal for using the Teppan Yaki and grill accessories in the flexible cooking zone.
- If the frying pans are a different size or are not arranged correctly, the FlexZone's frying sensor technology may not be activated. See the section entitled → "Flex function".
- Other types of frying pan may overheat and reach a temperature above or below the selected temperature level. Try the lowest temperature level to begin with and change it if necessary.

Any cookware that is suitable for induction cooking can be used for the cooking sensor. You can find information on which types of cookware can be used with an induction cooktop in the section entitled.

In the Cooking Assistant table, you can find the suitable cookware for each function.

Sensors and special accessories

The sensors measure the temperature of the cookware continuously. This regulates the cooking power very precisely in order to retain the correct temperature and achieve perfect cooking results.

Your cooktop has two different systems for temperature measurement in order to achieve the best results:

- Temperature sensors that are inside the cooktop and check the temperature at the base of the cookware. Suitable for frying sensor technology for frying pans.
- A wireless cooking sensor that transmits information about the temperature of the cookware to the control panel. Suitable for the cooking functions.

The cooking sensor is essential for using the cooking functions.

If your cooktop does not have a wireless cooking sensor, this can be retroactively purchased from specialist retailers, our technical customer service or our official website by quoting the reference number **CA060300**.

You can find more information about the wireless temperature sensor in the section entitled → "*Wireless cooking sensor*".

Functions and heat settings

Frying sensor technology for frying pans

If you are frying food, use this function to maintain the suitable frying pan temperature.

This function exists for all cooking zones.

Advantages when frying

- The cooking zone only continues heating for as long as this is necessary to maintain the temperature. This saves energy and prevents the oil or fat from overheating.
- The frying sensor technology reports when the empty frying pan has reached the optimum temperature for adding oil and then for adding the food.

Notes



- Do not place a lid on the frying pan. This will prevent the function from activating correctly. Use a splatter guard to prevent fat from spitting out.
- Use suitable oil or fat. If you are using butter, margarine, cold-pressed olive oil or lard, use temperature setting 1 or 2.
- Never leave fat or oil unattended while you are heating it.
- If the cooking zone is a higher temperature than the cookware or vice versa, the cooking sensor is not activated correctly.
- If you are frying with a large amount of oil, always use the following cooking sensor functions: Deep-fat fry a large amount of oil in a saucepan, set the temperature to 320 - 355° F (160–180 °C).

Temperature settings



Heat setting	Suitable for
1 Very low	Preparing and reducing sauces, steaming vegetables, and frying food in extra virgin olive oil, butter, or margarine.
2 Low	Frying food using extra virgin olive oil, butter, or margarine, e.g. omelettes.
3 Low – medium	Frying fish and thick food, such as, meatballs and sausages.
4 Medium – high	Frying steaks (medium or well done), frozen breaded products, thin fried food, such as schnitzel, strips of meat, and vegetables.
5 High	Frying food at high temperatures, e.g. rare steaks (bloody), potato fritters, and fried potatoes.

Setting procedure

Select the appropriate temperature setting from the table. Place the empty cooking vessel on the element.

1. Select the element and touch the  symbol.  lights up in the element display and the heat setting **A I** is displayed.



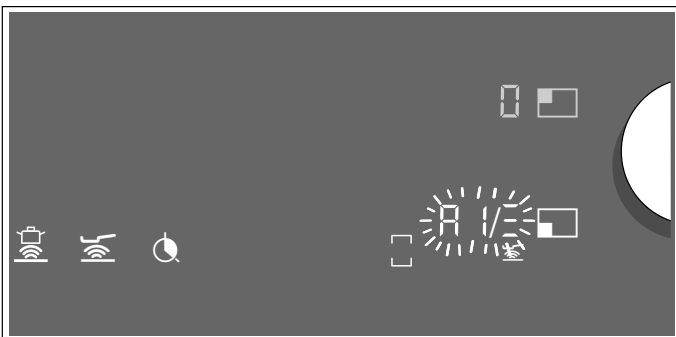

2. Within the next 10 seconds, select the required heat setting using the twist knob.
3. The element display shows the progress of the heating process from  to  and flashes alternately with the set heat setting. Once the set frying temperature has been reached, a signal will sound and the heating indicator will go out. The heat setting is displayed again.



4. Once the frying temperature has been reached, add the fat and then the food to the pan.

Note: Turn the food so that it does not burn.

Switch off the frying sensor technology for frying pans

Select the cooking zone and touch the  symbol or use the twist knob to set the  temperature level. A signal sounds and the  symbol goes out. The function has now been deactivated.

Cooking sensor

You can use these functions to heat, simmer or cook food, or cook it in a pressure cooker or fry it in a saucepan with sufficient oil at a controlled temperature.

These cooking functions are available for all cooking zones.

Advantages

- The cooking zone only heats up in order to maintain the temperature. This saves energy. Oil or fat will not overheat.
- The temperature is continuously monitored. This prevents the food from spilling over and you do not need to change the temperature level.
- The cooking sensor functions tell you when the water or oil has reached the optimal temperature for adding the food (see the exceptions in the table where the food should be added at the very beginning).

Notes

- Use saucepans and frying pans with a thick, flat base. Do not use saucepans and frying pans that have a thin or domed base.
- Fill the saucepan so that the contents reach high enough to cover the cooking sensor's silicone patch.
- If you are frying using just a little oil, always use the frying sensor technology for frying pans.
- Position the cookware in such a way that the wireless cooking sensor is pointing towards the outer side of the cooktop.
- Do not remove the wireless cooking sensor from the saucepan during cooking.
- After cooking, remove the wireless sensor from the saucepan. Take care as you do so because the wireless cooking sensor can become very hot.

Temperature ranges and settings

Cooking sensor	Temperature range °F (°C)	Suitable for
Heating/keeping warm	140 - 160 (60–70)	e.g. soups, punch
Poaching	175 - 195 (80–90)	e.g. rice, milk
Cooking	195 - 212 (90–100)	e.g. pasta, vegetables
Cooking in a pressure cooker	230 - 250 (110–120)	e.g. chicken, stew
Frying with a large amount of oil in the saucepan	340 - 355 (170–180)	e.g. doughnuts, dumplings

Tips for cooking with the cooking sensor

- Keeping warm/heating up: Portioned frozen products, e.g. spinach. Place the frozen product in the cookware. Add the volume of water specified by the manufacturer. Place a lid on the cookware and set the temperature to 160° F (70 °C). Stir occasionally.
- Poaching: This function is suitable for cooking food at low temperatures and for thickening sauces and stews. Set the temperature to 195° F (90 °C).
- Boiling: You can use this function to boil water with the lid on without it boiling over. The temperature control allows for efficient cooking. Set the temperature to 212° F (100 °C).
- Cooking in a pressure cooker: Follow the manufacturer's recommendations. After the audible signal sounds, continue cooking for the recommended time. Set the temperature to 240° F (115 °C).
- Frying with a large amount of oil in the saucepan: Heat the oil with the lid on. Remove the lid after the audible signal and add the food (insofar as there are no other instructions in the "Recommended dishes" table). Set the temperature to 340° F (170 °C).

Notes

- Always cook with the lid on, except when you use the function for frying with a large amount of oil in the saucepan, 340° F (170 °C).
- If no signal sounds, ensure that there is a lid on the container. For optimum operation of the cooking sensor, we recommend always using a lid, except when you use the function for deep-fat frying with a large amount of oil in the saucepan.
- Never leave oil unattended when it is being heated. Use oil that is suitable for deep-fat frying. Do not mix different cooking fats and oils – e.g. oil and lard – as such mixtures may foam up when hot.
- If you are not satisfied with the cooking result, e.g. when boiling potatoes, next time use more water. Maintain the recommended temperature level.

Setting the boiling point

The point at which water starts to boil depends on the height of your home above sea level. If the water is boiling too vigorously or not vigorously enough, you can set the boiling point. Proceed as follows:





- Select the basic setting $\zeta 5$; see the section entitled → "Basic settings".
- The basic setting is set to 3 by default. If your home is at an elevation between 200 and 400 m above sea level, there is no need to change the boiling point. If not, choose the correct setting from the following table according to your altitude:

Altitude	Setting value $\zeta 5$
0–100 m	1
100–200 m	2
200–400 m	3*
400–600 m	4
600–800 m	5
800–1000 m	6
1000–1200 m	7
1200–1400 m	8
Above 1400 m	9
* Basic setting	



Note: The temperature level 212° F (100 °C) is sufficient for efficient boiling, even if the water does not boil very quickly. However, you can change the boiling point. If, for example, you want it to boil more quickly, you can select a lower altitude.

Programming

The cooktop must be on.

1. Attach the wireless cooking sensor to the cookware; see the section entitled → "Preparing and caring for the wireless cooking sensor"
2. Place a saucepan filled with sufficient liquid on the required cooking zone and always put the lid on.
3. Select the required cooking zone using the twist knob.  appears in the display for the heat setting.
4. Press the  symbol in the control panel. An audible signal sounds. The  indicator lights up in the display for the cooking zone.
5. Press the symbol  on the wireless cooking sensor. Once the cooking sensor has been detected, the default temperature of 200°F (95 °C) lights up in the cooking zone display.



6. Set the desired temperature using the twist knob. The temperature can be changed by preset increments of 5 or 10° F (approx. 5°C).
7. The cooking zone display shows the progress of the heating process from  to  and flashes alternately with the set temperature. Once the set temperature has been reached, an audible signal sounds and the heating indicator goes out. The selected temperature will then be displayed again.

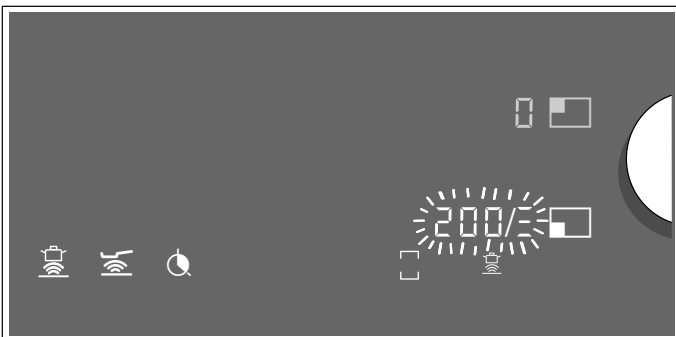

8. Remove the lid after the signal tone and add the food. Keep the lid closed during the cooking process.

Note: When using the fry with a lot of oil function, do not cover the pot.



You can call up the cooking sensor functions using the wireless cooking sensor. Proceed as follows:

- Place the cookware and press the  symbol on the wireless temperature sensor.
- Use the twist knob to select the cooking zone.

When the function is ready, the default temperature of 200° F is displayed.

Switching off the cooking sensor function

You can deactivate this function in a number of ways:



- Select the element and touch the  symbol.
- Select the element and set the temperature  using the twist knob.
- Press the  symbol on the wireless cooking sensor.



























A signal sounds and the  symbol goes out in the element display. The function is deactivated.

Table

The following table provides a selection of dishes and is sorted according to foods. Temperature and cooking time depend on the quantity, condition and quality of the foods.

Cooking assistance functions:

	Frying sensor technology for frying pans
	Cooking sensor

Meat	Cooking assistance functions	Temperature level °F (°C)	Total cooking time from the audible signal (mins)
Frying with a little oil			
Escalope, plain ¹		4	6 - 10
Escalope, breaded ¹		4	6 - 10
Fillet ²		4	6 - 10
Chops ¹		3	10 - 15
Cordon bleu ¹		4	10 - 15
Viennese schnitzel ¹		4	10 - 15
Steak, rare (1¼" / 3 cm thick) ²		5	6 - 8
Steak, medium (1¼" / 3 cm thick) ²		5	8 - 12
Steak, well done (1¼" / 3 cm thick) ¹		4	8 - 12
Poultry breast (¾" / 2 cm thick) ¹		3	10 - 20
Meat cut into strips ³		4	7 - 12
Gyros ³		4	7 - 12
Bacon ¹		2	5 - 8
Ground meat ³		4	6 - 10
Hamburgers (½" / 1.5 cm thick) ¹		3	6 - 15
Rissoles (¾" / 2 cm thick) ¹		3	10 - 20
Filled rissoles ¹		3	10 - 20
Boiled sausages ¹		3	8 - 20
Raw sausages ¹		3	8 - 20
Poaching			
Sausages ⁴		195 (90)	10 - 20
Cooking			
Meatballs ⁴		212 (100)	20 - 30
Stewing poultry ⁴		212 (100)	60 - 90
Viennese boiled beef ⁴		212 (100)	60 - 90
Cooking in a pressure cooker			
Stewing poultry ⁵		250 (115)	15 - 25
Viennese boiled beef ⁵		250 (115)	15 - 25
Frying with a large amount of oil			
Deep-fat frying chicken portions ⁶		340 (170)	10 - 15
Deep-fat frying meatballs ⁶		340 (170)	10 - 15

¹ Turn several times.

² Add the oil and the food after the audible signal.

³ Stir frequently.

⁴ Heat and cook with the lid on. Add the food after the audible signal sounds.

⁵ Add the food at the start.

⁶ Heat the oil with the lid on. Fry one portion after the other without the lid.

Fish	Cooking assistance functions	Temperature level °F (°C)	Total cooking time from the audible signal (mins)
Frying with a little oil			
Fish fillet, plain ¹		4	10 - 20
Fish fillet, breaded ¹		3	10 - 20
Scampi ¹		4	4 - 8
Shrimps ¹		4	4 - 8
Fried whole fish ¹		3	10 - 20
Poaching			
Braised fish ²		195 (90)	15 - 20
Frying with a large amount of oil			
Deep-fat frying fish in beer batter ³		340 (170)	10 - 15
Deep-fat frying breaded fish ³		340 (170)	10 - 15

¹ Turn several times.

² Heat and cook with the lid on. Add the food after the audible signal sounds.

³ Heat the oil with the lid on. Fry one portion after the other without the lid.

Egg dishes	Cooking assistance functions	Temperature level °F (°C)	Total cooking time from the audible signal (mins)
Frying with a little oil			
Fried eggs in butter ¹		2	2 - 6
Fried eggs ²		4	2 - 6
Scrambled eggs ³		2	4 - 9
Omelettes ⁴		2	3 - 6
Crêpes ⁴		5	1,5 - 2,5
French toast ⁴		3	4 - 8
Shredded raisin pancake ⁴		3	10 - 15
Cooking			
Boiled eggs ⁵		212 (100)	5 - 10

























¹ Add butter and the food after the audible signal sounds.

² Add the oil and food to the frying pan after the audible signal sounds.

³ Stir frequently.

⁴ Total cooking time per portion. Fry one after the other.

⁵ Add the food at the start.

Vegetables and legumes	Cooking assistance functions	Temperature level °F (°C)	Total cooking time from the audible signal (mins)
Frying with a little oil			
Garlic ¹		2	2 - 10
Onions, sautéed ¹		2	2 - 10
Onion rings ¹		3	5 - 10
Zucchini ²		3	4 - 12
Eggplant ²		3	4 - 12
Peppers ¹		3	4 - 15
Frying green asparagus ²		3	4 - 15
Mushrooms ¹		4	10 - 15
Sautéing vegetables in oil ¹		1	10 - 20
Glazed vegetables ¹		3	6 - 10
Cooking			
Broccoli ³		212 (100)	10 - 20
Cauliflower ³		212 (100)	10 - 20
Brussels sprouts ³		212 (100)	30 - 40
Green beans ³		212 (100)	15 - 30
Chickpeas ⁴		212 (100)	60 - 90
Peas ³		212 (100)	15 - 20
Lentils ⁴		212 (100)	45 - 60
Cooking in a pressure cooker			
Vegetables in a pressure cooker ⁴		250 (115)	3 - 6
Chickpeas in a pressure cooker ⁴		250 (115)	25 - 35
White beans in a pressure cooker ⁴		250 (115)	25 - 35
Lentils in a pressure cooker ⁴		250 (115)	10 - 20
Frying with a large amount of oil			
Deep-fat frying breaded vegetables ⁵		340 (170)	4 - 8
Deep-fat frying vegetables in beer batter ⁵		340 (170)	4 - 8
Deep-fat frying breaded mushrooms ⁵		340 (170)	4 - 8
Deep-fat frying mushrooms in beer batter ⁵		340 (170)	4 - 8





¹ Stir frequently.

² Turn several times.

³ Heat and cook with the lid on. Add the food to the frying pan after the audible signal sounds.

⁴ Add the food at the start.

⁵ Heat the oil with the lid on. Fry one portion after the other without the lid.

Potatoes	Cooking assistance functions	Temperature level °F (°C)	Total cooking time from the audible signal (mins)
Frying with a little oil			
Fried potatoes (made from unpeeled boiled potatoes) ¹		5	6 - 12
French fries (made from raw potatoes) ¹		4	15 - 25
Potato pancakes ²		5	2,5 - 3,5
Swiss rösti ³		2	50 - 55
Glazed potatoes ¹		3	10 - 15

Poaching			
Cooking potato dumplings ⁴		185 (85)	30 - 40

Cooking			
Boiling potatoes ⁵		212 (100)	30 - 45

Cooking in a pressure cooker			
Potatoes in a pressure cooker ⁵		250 (115)	10 - 20



¹ Stir frequently.



² Total cooking time per portion. Fry one after the other.

³ Add the oil and food to the frying pan after the signal sounds.

⁴ Heat and cook with the lid on. Add the food after the audible signal sounds.

⁵ Add the food at the start.

Pasta and cereals	Cooking assistance functions	Temperature level °F (°C)	Total cooking time from the audible signal (mins)
Poaching			
Rice ¹		195 (90)	25 - 35
Polenta ²		185 (85)	3 - 8
Semolina pudding ²		185 (85)	5 - 10



Cooking			
Pasta ²		212 (100)	7 - 10
Dumplings ²		212 (100)	6 - 15

Cooking in a pressure cooker			
Rice in a pressure cooker ³		250 (115)	5 - 8

¹ Heat and cook with the lid on. Add the food after the audible signal sounds.

² Stir frequently.

³ Add the food at the start.

Soups	Cooking assistance functions	Temperature level °F (°C)	Total cooking time from the audible signal (mins)
Poaching			
Instant creamy soups ¹		195 (90)	10 - 15
Cooking			
Home-made broths ²		212 (100)	60 - 90
Instant soups ¹		212 (100)	5 - 10





¹ Stir frequently.

² Add the food at the start.







Soups	Cooking assistance functions	Temperature level °F (°C)	Total cooking time from the audible signal (mins)
Cooking in a pressure cooker			
Home-made broths in a pressure cooker ²		250 (115)	20 - 30

¹ Stir frequently.

² Add the food at the start.

Sauces	Cooking assistance functions	Temperature level	Total cooking time from the audible signal (mins)
Frying with a little oil			
Tomato sauce with vegetables ¹		1	25 - 35
Béchamel sauce ¹		1	10 - 20
Cheese sauce ¹ \		1	10 - 20
Reducing sauces ¹		1	25 - 35
Sweet sauces ¹		1	15 - 25













¹ Stir frequently.

Dessert	Cooking assistance functions	Temperature level °F (°C)	Total cooking time from the audible signal (mins)
Poaching			
Rice pudding ¹		185 (85)	40 - 50
Porridge ¹		185 (85)	10 - 15
Chocolate pudding ¹		185 (85)	3 - 5
Cooking			
Compote ²		212 (100)	15 - 25
Frying with a large amount of oil			
Deep-fat frying jam-filled doughnuts ³		320 (160)	5 - 10
Deep-fat frying ring doughnuts ³		320 (160)	5 - 10
Deep-fat frying buñuelos ³		320 (160)	5 - 10

¹ Stir frequently.

² Add the food at the start.

³ Heat the oil with the lid on. Fry one portion after the other without the lid.

Frozen products	Cooking assistance functions	Temperature level °F (°C)	Total cooking time from the audible signal (mins)
Frying with a little oil			
Escalope ¹		4	15 - 20
Cordon bleu ¹		4	10 - 30
Poultry breast ¹		4	10 - 30
Chicken nuggets ¹		4	10 - 15
Gyros ²		4	10 - 15
Kebab ²		4	10 - 15
Fish fillet, plain ¹		3	10 - 20
Fish fillet, breaded ¹		3	10 - 20
Fish sticks ¹		4	8 - 12
Frying French fries ²		5	4 - 6
Stir-fries ²		3	6 - 10
Spring rolls ¹		4	10 - 30
Camembert ¹		3	10 - 15

Keeping warm, heating

Vegetables in cream sauce ²		160 (70)	15 - 20
--	---	----------	---------

Cooking

Green beans, frozen ³		212 (100)	15 - 30
----------------------------------	---	-----------	---------

Frying with a large amount of oil









Deep-fat frying French fries ⁴		355 (180)	4 - 8
---	--	-----------	-------

¹ Turn several times.

² Stir frequently.

³ Heat and cook with the lid on. Add the food after the audible signal sounds.

⁴ Heat the oil with the lid on. Fry one portion after the other without the lid.

Miscellaneous	Cooking assistance functions	Temperature level °F (°C)	Total cooking time from the audible signal (mins)
Frying with a little oil			
Camembert ¹		3	7 - 10
Croutons ²		3	6 - 10
Dried ready meals ³		1	5 - 10
Toasting almonds ⁴		4	3 - 15
Toasting nuts ⁴		4	3 - 15
Toasting pine nuts ⁴		4	3 - 15
Keeping warm, heating			
Heating goulash soup ⁵		160 (70)	10 - 20
Heating mulled wine ⁵		160 (70)	5 - 15
Poaching			
Heating milk ⁵		185 (85)	3 - 10

¹ Turn several times.

² Stir frequently.

³ Add the water after the audible signal sounds. Add the food as soon as the water boils.

⁴ Add the food after the audible signal sounds.

⁵ Add the food at the start.

Teppan Yaki for the Flex Zone

The Teppan Yaki accessories are ideal for the flexible cooking zone and are optimal cookware for using the frying sensor technology.

























Teppan Yaki

The Teppan Yaki means that you can cook meat, fish, seafood, vegetables, desserts and bread with very little oil, easily and healthily. The Teppan Yaki adapts perfectly to the Flex Zone. Direct contact with the plate and uniform heat transfer make it possible to retain the

consistency, color and succulence of the food when searing and browning.

The following table shows a selection of dishes and is arranged by food type. The temperature and the cooking time depend on the amount, the condition and the quality of the food.

Note: Set up the Flex Zone as a single cooking zone to ensure the function is activated correctly.

	Cookware	Temperature level	Total frying time after the signal tone sounds (min)
Meat			
Escalope, plain ¹		4	6 - 10
Fillet ¹		4	6 - 10
Chops ¹		3	10 - 15
Steak, rare (1¼" / 3 cm thick) ¹		5	6 - 8
Steak, medium (1¼" / 3 cm thick) ¹		5	8 - 12
Steak, well done (1¼" / 3 cm thick) ¹		4	8 - 12
Poultry breast (¾" / 2 cm thick) ¹		3	10 - 20
Bacon ¹		3	5 - 8
Hamburgers ¹		3	6 - 15
Boiled sausages ¹		4	8 - 20
Raw sausages ¹		4	8 - 20
Gyros ²		4	7 - 12
Ground meat ²		4	6 - 10
Fish and seafood			
Fish fillet, plain ¹		4	10 - 20
Scampi ¹		4	4 - 8
Prawns ¹		4	4 - 8
Frying fish, whole ¹		3	15 - 30
Vegetables			
Zucchini ¹		3	4 - 12
Eggplant ¹		3	4 - 12
Peppers ¹		3	4 - 15
Frying green asparagus ¹		3	4 - 15
Mushrooms ²		4	10 - 15
Garlic ²		2	2 - 10
Sweating onions ²		2	2 - 10
Glazing vegetables ²		3	6 - 10
Potatoes			

¹ Add oil (if necessary) and the food after the signal tone sounds. Turn if necessary.















² Add oil (if necessary) and the food after the signal tone sounds. Stir regularly.

³ Add butter and the food after the signal tone sounds. Turn if necessary.

⁴ Add oil (if necessary) and the food after the signal tone sounds. Total cooking time per portion. Fry individually.

⁵ Add oil (rub into the food) and the food after the signal tone sounds. Turn if necessary.

⁶ Add the food after the signal tone sounds.

	Cookware	Temperature level	Total frying time after the signal tone sounds (min)
Fried potatoes (made from unpeeled boiled potatoes) ²		5	6 - 12
Potato pancakes ⁴		5	2.5 - 3.5
Glazed potatoes ²		3	10 - 15
Egg dishes			
Fried eggs in butter ³		2	2 - 6
Fried eggs in oil ¹		4	2 - 6
Scrambled eggs ²		2	4 - 9
Omelettes ⁴		2	3 - 6
Pancakes ⁴		5	1.5 - 2.5
French toast ⁴		3	4 - 8
Shredded raisin pancake ⁴		3	10 - 15
Miscellaneous			
Toasting ⁵		4	4 - 6
Croûtons ²		3	6 - 10
Toasting almonds ⁶		4	3 - 15
Toasting nuts ⁶		4	3 - 15
Toasting pine nuts ⁶		4	3 - 15

¹ Add oil (if necessary) and the food after the signal tone sounds. Turn if necessary.

² Add oil (if necessary) and the food after the signal tone sounds. Stir regularly.

³ Add butter and the food after the signal tone sounds. Turn if necessary.

⁴ Add oil (if necessary) and the food after the signal tone sounds. Total cooking time per portion. Fry individually.

⁵ Add oil (rub into the food) and the food after the signal tone sounds. Turn if necessary.

⁶ Add the food after the signal tone sounds.

Wireless cooking sensor

Before you use the cooking sensor functions for the first time, connect the wireless temperature sensor to the control panel.

Preparing and caring for the wireless cooking sensor

This section provides information on:

- Attaching the silicone patch
- Attaching the wireless cooking sensor
- Cleaning
- Changing the battery

Silicone patches and cooking sensors can be purchased from specialist retailers, our technical customer service or our official website. To do this, quote the relevant reference number:

00577921	Set of five silicone patches
CA060300	Cooking sensor and set of five silicone patches

Gluing on the silicone patch

The silicone patch secures the cooking sensor to the cookware.

If you are using a saucepan with the cooking sensor functions for the first time, attach the silicone patch directly onto the saucepan. Proceed as follows:

1. The part of the cookware to which the patch is to be adhered must be free of grease. Clean the pan, dry it thoroughly and wipe the area where the patch is to be adhered with an all purpose degreasing agent.
2. Remove the protective film from the silicone patch. Adhere the silicone patch in the correct place on the outside of the pot using the supplied template as a guide.

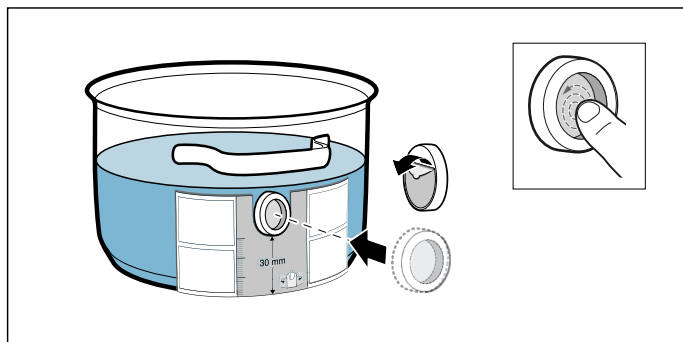

3. Press down all over the surface of the silicone patch, including in the center.

The adhesive requires 1 hour to fully cure. Do not use or clean the pot during this time.

Notes

- Do not leave the pot with the silicone patch to soak in soapy water for long periods of time.
- If the silicone patch comes off, replace it with a new one.

Attaching the wireless cooking sensor

Place the cooking sensor squarely onto the silicone patch.

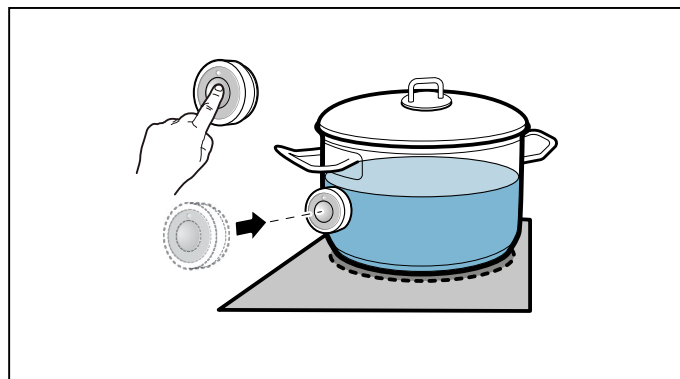

Notes

- Make sure that the silicone patch is completely dry before attaching the wireless cooking sensor.
- Position the cookware in such a way that the wireless cooking sensor is pointing towards the outer side of the cooktop.
- To prevent overheating, the wireless cooking sensor must not be pointed towards another item of cookware that is hot.
- Remove the wireless cooking sensor from the cookware after cooking. Store it in a clean, safe place away from sources of heat.
- You can use up to three wireless cooking sensors at the same time.

Connecting the wireless cooking sensor to the control panel

To connect the wireless cooking sensor to the control panel, proceed as follows:

1. Select the basic setting $\square 5$; see the section entitled → "Basic settings".
• The \square symbol lights up white.
2. Touch the \square symbol. A signal sounds and the \square symbol lights up orange. The cooking zone indicators light up white and the cooking sensor indicators on the cooking zones flash.

Briefly touch the \square symbol on the wireless cooking sensor within the next 30 seconds.

3. **Detection successful:** The wireless temperature sensor is detected within a few seconds. Three short beeps sound and the  symbol changes from orange to white. The cooking sensor indicators on the cooking zones go out.

Detection failed: Five beeps sound. The  symbol changes immediately from orange to white and the cooking sensor indicators on the cooking zones go out.

- The cooking functions are made available as soon as the wireless cooking sensor has been connected to the control panel correctly.
- If there is a fault with the wireless cooking sensor, the connection may not be established correctly for the following reasons:
 - Bluetooth communication error.
 - You have not pressed the  symbol on the cooking sensor within 30 seconds of selecting the cooking zone.
 - The battery in the wireless cooking sensor is almost flat.

Reset the wireless cooking sensor and repeat the connection procedure.

- If there are problems with the connection due to a transmission error, repeat the connection procedure. If no connection can be established, inform customer service.

Resetting the wireless cooking sensor

1. Touch and hold the  symbol for approximately 8-10 seconds.

While you are doing this, the temperature sensor's LED indicator will light up three times. When the LED lights up for the third time, it will start to reset the temperature sensor. At this point, you will need to lift your finger off the symbol.

Once the LED goes out, this means that the wireless temperature sensor has been reset.

2. Repeat the connection process from point 2.

Cleaning

Do not clean the wireless cooking sensor in the dishwasher.

Wireless cooking sensor

Clean with a damp cloth. Never put in the dishwasher, never get wet.

If the wireless cooking sensor is not used, remove it from the cookware and keep it in a clean, safe place and not near heat sources.

Silicone patch

Clean and dry before attaching to the wireless cooking sensor. Suitable for dishwashers.

Note: Do not leave utensils with the silicone patch in soapy water for long periods of time.

Cooking sensor window

The sensor window must always be clean and dry. Proceed as follows:

- Remove dirt and oil splatters regularly.
- For cleaning, use a soft cloth or Q-tips and window cleaner.

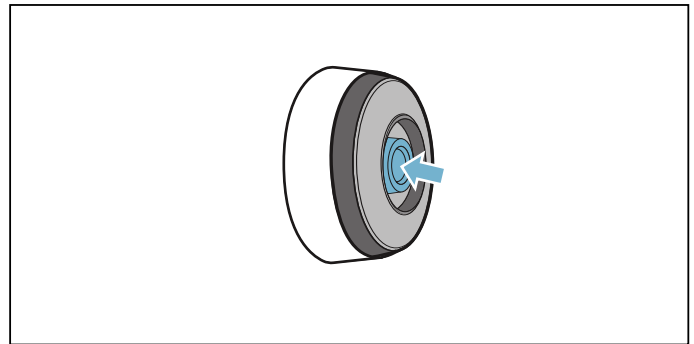

Notes

- Do not use abrasive cleaning products such as scouring pads, scrubbing brushes or cream cleaners.
- Do not touch the sensor window with your fingers. This may make it dirty or scratch it.

Changing the battery

If the cooking sensor does not light up when the symbol is pressed, the battery no longer has a charge.

Replacing the battery:

1. Remove the silicone cover from the lower section of the cooking sensor casing and remove both screws using a screwdriver.

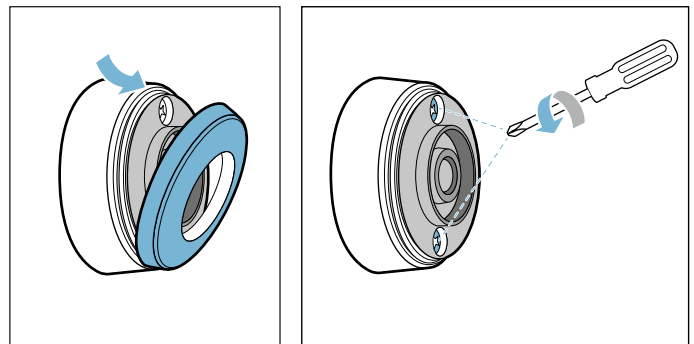

2. Open the cap on the cooking sensor. Remove the battery from the lower section of the casing and insert a new battery (make sure that the battery terminals (+/-) are the right way round).

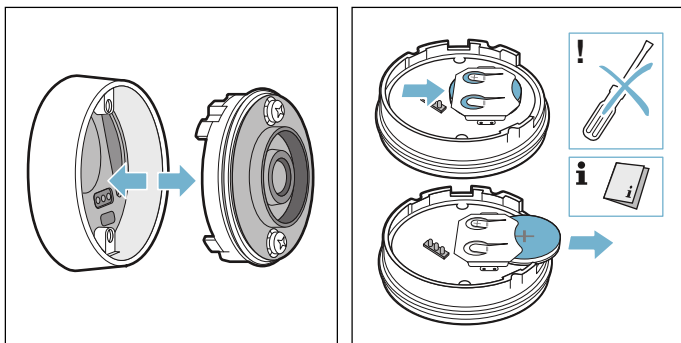

⚠ CAUTION

Do not use metal objects to remove the battery.
Do not touch the battery terminals.

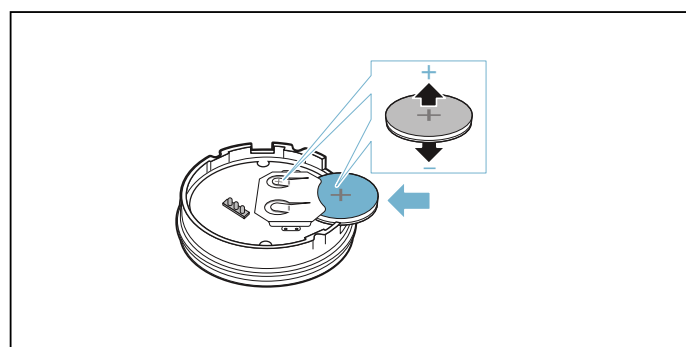

3. Close the cap on the cooking sensor (the indentations for the screws on the cap must be aligned with the indentations on the lower section of the casing). Tighten the screws with a screwdriver.

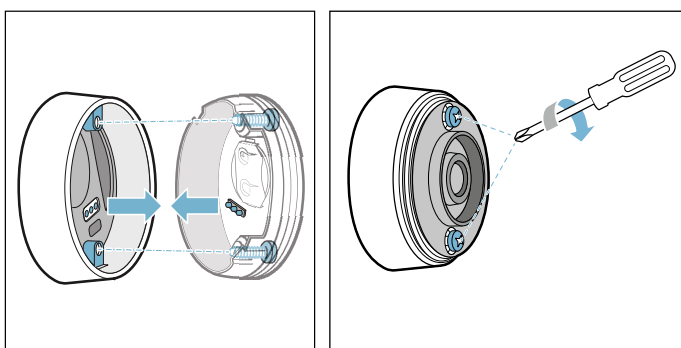

4. Put the silicone cover back on the lower section of the cooking sensor casing.

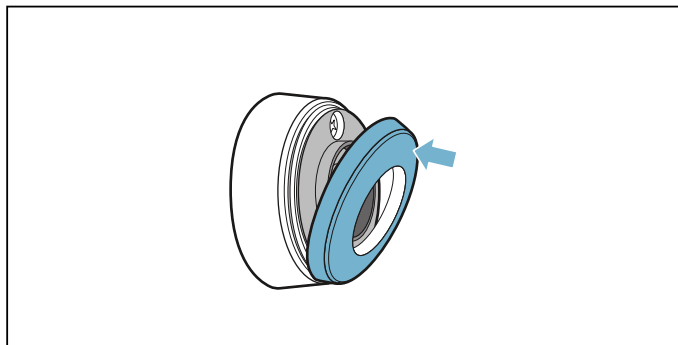

Note: Use only high-quality CR2032 batteries in order to maintain a long service life.

Declaration of Conformity

Gaggenau Hausgeräte GmbH hereby declares that the appliance with wireless cooking sensor function meets the basic requirements and other relevant provisions of the Directive 2014/53/EU.

A detailed RED Declaration of Conformity can be found online at www.gaggenau.com among the additional documents on the product page for your appliance.

The logos and the Bluetooth® brand are registered trademarks and property of Bluetooth SIG, Inc. These trademarks are used by Gaggenau Hausgeräte GmbH under license. All other trademarks and brand names are owned by the respective companies.

Childproof lock

Activating and deactivating the childproof lock

The cooktop must be switched off.

To activate: Remove the twist knob from the cooktop. A signal sounds. The  indicator lights up for 10 seconds. The cooktop is locked.

To deactivate: Place the twist knob on the twistpad.

Note: Removing the twist knob when the cooktop is switched on initially activates the cleaning protection display. If the twist knob is not put back on after 10 minutes, the cooktop switches itself off and the child lock is activated.

Display cleaning protection

If you wipe over the control panel while the cooktop is switched on, settings may be changed. To avoid this, the cooktop has a function you can use to lock the control panel for cleaning.

Activating: Remove the twist knob. An audible signal sounds. The  indicator and the cooktop settings flash. The heating process is interrupted. If a cooking timer is programmed, this will be paused. The control panel is locked for 10 minutes. You can now wipe over the surface of the control panel without altering the settings.

Deactivating: Put the twist knob back on within 10 minutes. The control panel is unlocked. The cooktop reheats to the previous settings. To end the function early, put the twist knob back on before the 10 minutes have elapsed.

Automatic shut-off

If an element has been in operation for a longer period and no settings are changed, the automatic safety shut-off function is activated.

The element ceases to heat up. A signal sounds and the residual heat indicator *h* or *H* appears on the element display.

The element can be selected again at any time and re-set.

When the automatic safety shut-off is activated depends on which heat setting has been set (after 1 to 10 hours).

Basic settings

The appliance has various basic settings. These basic settings can be altered to suit your individual requirements.

Display screen	Function
	Signal tones
<i>c 1</i>	<i>00</i> All signals are switched on.* <i>0FF</i> Most of the signals are switched off.
	Time for selecting the element
<i>c 2</i>	<i>5</i> The element remains selected for 5 seconds. <i>10</i> The element remains selected for 10 seconds.* <i>15</i> The element remains selected for 15 seconds. <i>0FF</i> Unlimited: The element that was set last remains selected.
<i>c 3</i>	Power management function. Limiting the total power of the cooktop <i>0</i> Deactivated. Maximum power of the cooktop.*/** <i>1</i> 1000 W minimum power. <i>1.5</i> 1500 W ... <i>3</i> 3000 W recommended for 13 A. <i>3.5</i> 3500 W recommended for 16 A. <i>4</i> 4000 W <i>4.5</i> 4500 W Recomendada para 20 Amperios. ... <i>9</i> or <i>9.5</i> Maximum power of the cooktop.**
	Restoring the factory settings
<i>c 4</i>	<i>0FF</i> Keep personal settings.* <i>00</i> Restore factory settings.
<i>c 5</i>	Cooking sensor Connect the wireless cooking sensor to the cooktop. Set according to height above sea level: <i>1 - 2</i> Decrease <i>3</i> Basic setting <i>4 - 9</i> Increase
<i>c 6</i>	Professional cooking function Select a single cooking zone in order to preset the power level for the professional cooking function.
<i>c 7</i>	Cookware, checking the result of the cooking process <i>0</i> Not suitable <i>1</i> Not perfect <i>2</i> Suitable



Home Connect

→ "Home Connect Settings" on page 47

*Factory setting



**The cooktop's maximum power output is shown on the rating label.

To access the basic settings:

The cooktop must be switched off.

1. Turn on the cooktop.
2. Touch the  symbol within the next 10 seconds.
The first four displays provide product information.
Turn the twist knob to view the individual displays.

Product information	Display screen
Customer service index (CSI)	01
FD number	Fd
FD number 1	95.
FD number 2	0.5

3. Touch the  symbol again to access the basic settings.
 and  light up as a presetting in the displays.

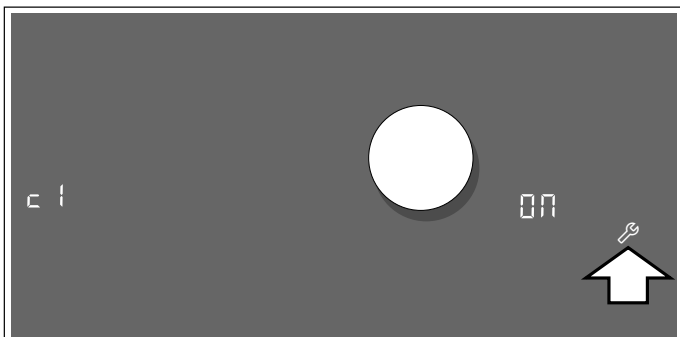

4. Touch the  symbol repeatedly until the required function is displayed.
5. Then use the twist knob to select the required setting.

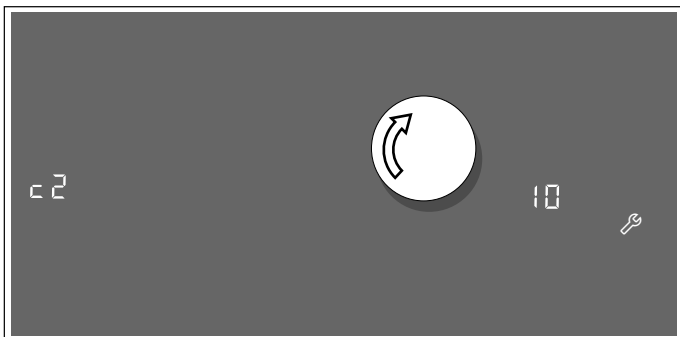

6. Touch the  symbol for at least 4 seconds.

The settings have been saved.

Leaving the basic settings

Turn off the cooktop with the main switch.

Home Connect

This appliance is Wi-Fi enabled and settings can be sent to the appliance via a mobile device.

If the appliance is not connected to the home network, the appliance functions in the same way as a cooktop with no network connection. The cooktop can always be operated via the control panel.

The availability of the Home Connect function depends on the availability of Home Connect services in your country. Home Connect services are not available in every country. You can find more information on this at www.home-connect.com.

Notes

- Cooktops are not designed to be used unattended – you must always keep an eye on the cooking process.
- Ensure that you follow the safety instructions in this instruction manual and that these are also observed when operating the appliance via the Home Connect app. Follow the instructions in the Home Connect app.
- Using the Home Connect app, you can send settings to your appliance, and you must then confirm these on the appliance. It is not possible to operate the appliance while you are away from home.
- If the appliance is being operated by the controls on the appliance itself, this mode of operation always has priority. It is not possible to operate the appliance using the Home Connect app during this time.

Setting Up

To implement settings via Home Connect, you must have installed and set up the Home Connect app on your mobile device.

Note: In networked standby mode, your appliance requires a maximum of 2 W.

Setting up the Home Connect app

Note: You require a mobile device with the latest version of the relevant operating system.



1. On your mobile device, go to the App Store (Apple devices) or to the Google Play Store (Android devices).
2. Enter "Home Connect" in the search field.
3. Select the Home Connect app and install it on your mobile device.

4. Start the app and create your Home Connect login details. The app will guide you through the registration process. Make a note of your e-mail address and password.

Automatic Registration in the Home Network

You require a router that has WPS functionality. You will find information about this in the manual for your router. You need to be able to access your router.

If you do not have this, follow the steps under "Manually logging into your home network".

1. Open the basic settings.
2. Touch the  symbol repeatedly until the **HC 1** setting appears.
3. Touch the  symbol to open the Home Connect settings.
HC 1 and **NET** flash alternately in the settings area.
OFF lights up on the cooking zone display.

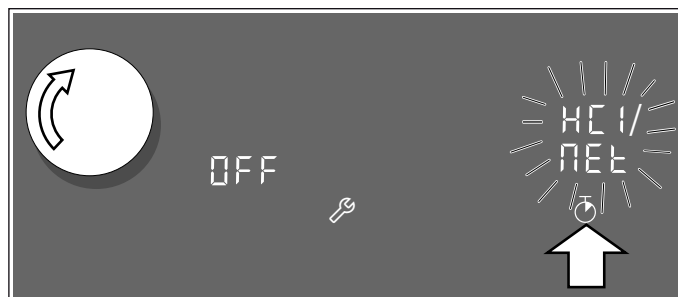

4. Set the value to **CO 1** using the twist knob.
CO 1 flashes on the cooking zone display along with the  symbol.
5. Press the WPS button on the router within the next two minutes.

The cooktop is connected to the network when the  symbol is no longer flashing but lights up on the control panel.

Note: If a connection cannot be established, the "Connect manually" **CO 2** value appears. Log the appliance into your home network manually or try connecting automatically again.

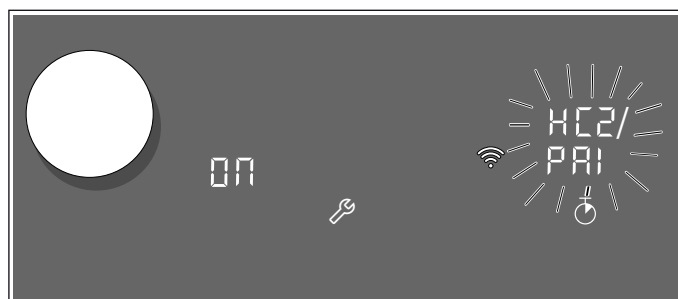



The appliance tries to connect to the app automatically. **HC 2** and **PA 1** flash alternately in the settings area. The **ON** value flashes on the cooktop display.

6. Start the app on your mobile device and follow the instructions for automatic network registration.

When the **ON** value stops flashing on the cooking zone display and the **OFF** value lights up again, the registration process is complete.

Manual Registration in the Home Network

Note: To log in to the home network (Wi-Fi) manually, you require the network name (SSID) and password (key) for your home network.

1. Open the basic settings.
2. Touch the  symbol repeatedly until the **HC 1** setting appears.
3. Touch the  symbol to open the Home Connect settings.
HC 1 and **NET** flash alternately in the settings area.
OFF lights up on the cooking zone display.

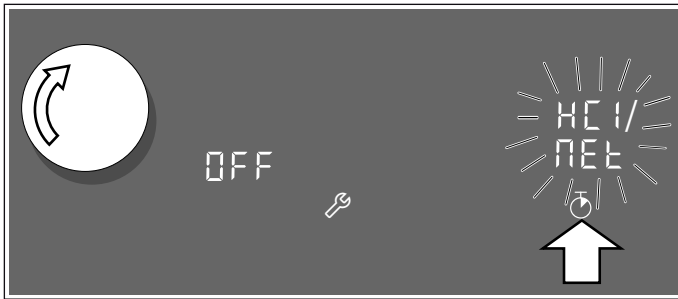

4. Set the value to **C02** using the twist knob.
C02 flashes on the cooking zone display along with the  symbol.



5. Switch to the general settings menu of your mobile device and call up the Wi-Fi settings.

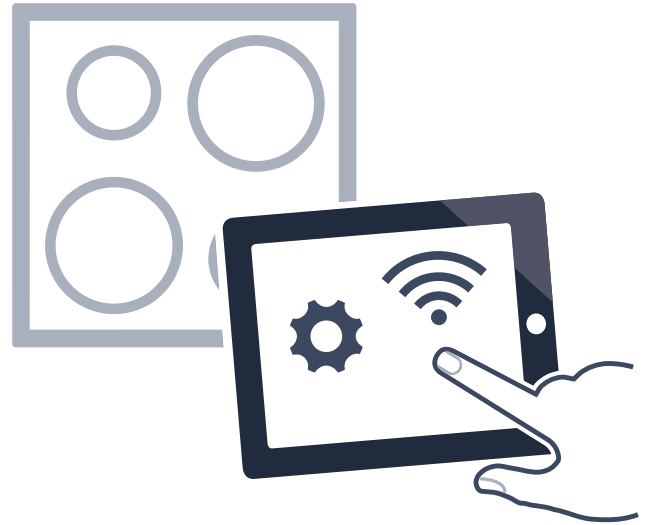

6. Use the "Home Connect" SSID and the "Home Connect" key register your mobile device on the cooktop network. It can take up to 60 seconds to establish the connection.
7. Once you have connected successfully, open the Home Connect app.

The app will now take a few seconds to search for your cooktop. Once the cooktop has been found, you will be prompted – if not already the case – to enter the network name (SSID) and password (key) for your home network (Wi-Fi) in the corresponding fields.

8. Then press "Transfer to household appliance".
9. The cooktop is connected to the home network when the  symbol lights up in the control panel.

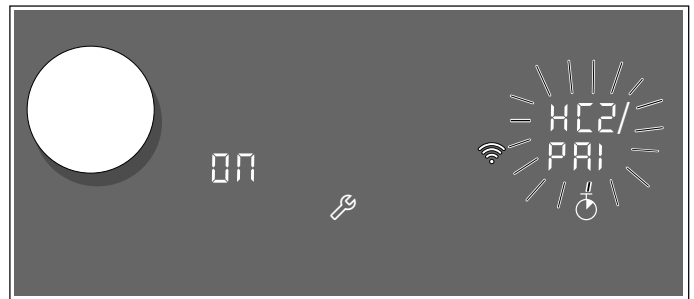

The appliance tries to connect to the app automatically. **HC 2** and **PA 1** flash alternately in the settings area. The **ON** value flashes on the cooktop display.

When the **ON** value stops flashing on the cooking zone display and the **OFF** value lights up again, the registration process is complete.

You can then reconnect your mobile device to your home network.

Follow the instructions in the app.

Home Connect Settings

You can adjust Home Connect to suit your requirements at any time.

In the basic settings for your cooktop, navigate to the Home Connect settings to display network and appliance information.

Display	Function
HC 1 / NET	Registration in the home network (Wi-Fi)
OFF	Not connected/disconnect network
CO 1	Connecting automatically
CO 2	Connecting manually
ON	Connected
HC 2 / PR 1	Connection to app
OFF	Not connected/ registration process complete
ON	Connecting
HC 3 / CON	Connection to home network (Wi-Fi)
OFF	Wireless module switched off
ON	Wireless module switched on
HC 4 / FES	Settings via app
OFF	Switched off
ON	Switched on*
HC 5 / UPd	Software update
dEF	Update available and ready for installation
INS	Start installation
HC 6 / FEd	Remote access by customer service
OFF	Not permitted
ON	Permitted
HC 7 / SEr	Wi-Fi signal strength
NR	Not connected to home network (Wi-Fi)
1	Signal strength 1 (weak)
2	Signal strength 2 (moderate)
3	Signal strength 3 (good)
HC 8 / SEr	Connection to Home Connect server
NR	Not connected
ON	Connected

* Basic setting

Notes

- The **HC 2** setting is only displayed if the appliance is connected to the home network.
- The **HC 3** setting is only displayed if the appliance has previously been connected to a network.
- The **HC 5** setting is only displayed if an update is available.
- The **HC 6** setting is only displayed if customer service is attempting to connect to the appliance. You can end this at any time after granting access.
- The **HC 7** and **HC 8** settings are only displayed if there is a connection to the Wi-Fi.

Deactivating Wi-Fi

If Wi-Fi has been activated, you can use the Home Connect functions.

Note: In networked standby mode, your appliance requires a maximum of 2 W.

1. Open the basic setting **c 9**.
2. Touch the  symbol repeatedly until the **HC 3** and **CON** settings flash alternately. **ON** lights up on the cooking zone display.

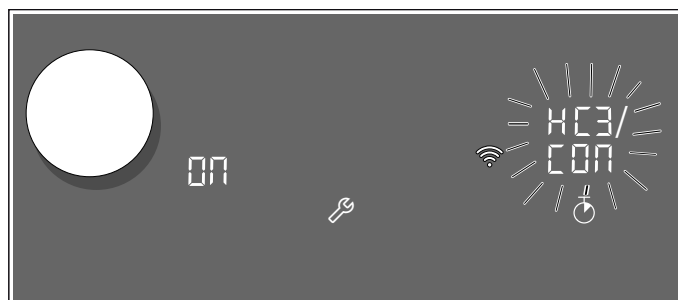

3. Set the value to **OFF** using the twist knob.

This deactivates the Wi-Fi and the  symbol goes out on the control panel.

Note: The network settings are saved. When the Wi-Fi function is reactivated, the cooktop starts searching for a connection to the saved network.

Disconnecting from the Network

You can disconnect your cooktop from the network at any time.

Note: If your cooktop is disconnected from the network, it is not possible to operate it using Home Connect.

1. Open the basic setting **c 9**.
2. Touch the  symbol repeatedly until the **HC 1** and **NET** settings flash alternately. **ON** lights up on the cooking zone display.
3. Set the value to **OFF** using the twist knob.

This disconnects the appliance from your home network; the  symbol on the control panel goes out.

Connecting to the network

1. Open the basic setting **c9**.
2. Touch the  symbol repeatedly until the **HC1** and **NET** settings flash alternately.
OFF lights up on the cooking zone display.

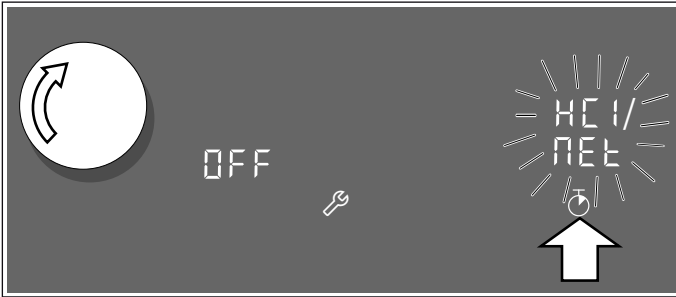

3. Use the twist knob to set the value to **CO1**, "Connect automatically", or **CO2** "Connect manually".
4. Follow the instructions in the section entitled "Automatic registration in the home network" or "Manual registration in the home network".

Connect to App

If the Home Connect app is installed on your mobile device, you can connect it to your cooktop.

Notes

- The appliance must be connected to the network.
- The app must be open and be set up.
- If your extractor hood is directly connected, first disconnect the cooktop from your home network and then initiate the connection process again. ,
→ "Connecting to the network" on page 48

1. Open the basic setting **c9**.
2. Touch the  symbol repeatedly until the **HC2** and **PA1** settings flash alternately.
OFF lights up on the cooking zone display.

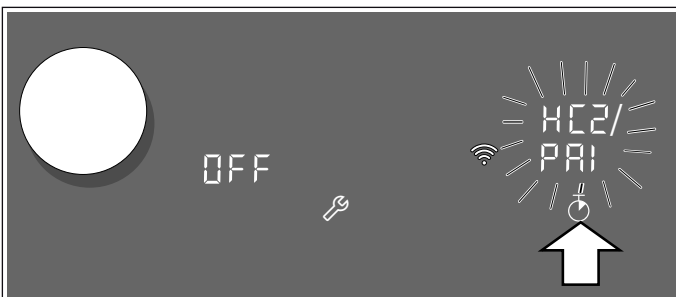

3. Set the value to **ON** using the twist knob.
4. Launch the app on your mobile device and follow the instructions to complete the connection process.

When the **ON** value stops flashing on the cooking zone display and the **OFF** value lights up again, the registration process is complete.

Settings via app

Using the Home Connect app, you can easily access the basic settings for your cooktop and send settings for the cooking zones to the cooktop.

Notes

- Before you can change the basic settings, the cooktop must be switched off.
- Operating the appliance directly from the appliance always takes priority. It is not possible to operate the appliance using the Home Connect app during this time.
- When the appliance is delivered, the settings transfer option is already activated by default.
- If the settings transfer option has been deactivated, only the cooktop's operating statuses will be displayed in the Home Connect app.

1. Open the basic setting **c9**.
2. Touch the  symbol repeatedly until the **HC4** and **FES** settings flash alternately.
3. To activate transfer, select the **ON** value with the twist knob. To deactivate transfer, select the **OFF** value.

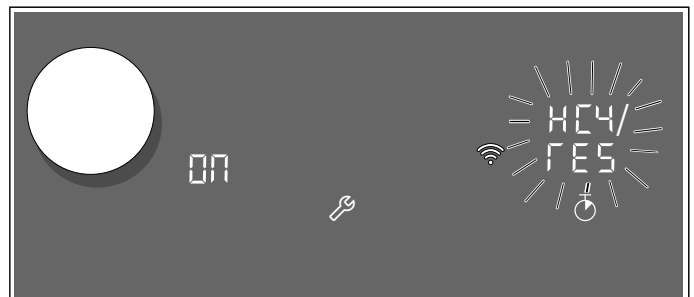

Confirming settings

As soon as cooking settings are transmitted to a cooking zone, the cooking zone display starts to flash. To confirm that you want to use these settings, touch the flashing indicator . To discard the settings, touch any other button on the cooktop.

Software update

Using the software update function, your cooktop's software can be updated (e.g. for the purpose of optimization, troubleshooting or security updates). To do this, you need to be a registered Home Connect user, have installed the app on your mobile device and be connected to the Home Connect server.

As soon as a software update is available, you will be informed by the Home Connect app, from which you will also be able to download the update.

Once the update has been successfully downloaded, you can start installing it via the cooktop (basic settings, settings \llcorner **HC S/UPd** setting) or the Home Connect app if you are on your local area network.

The Home Connect app will notify you once installation is complete.

Notes

- You can continue to use your cooktop as normal while updates are downloading.
- Depending on your personal settings in the app, software updates can also be set to download automatically.
- We recommend that you install security updates as soon as possible.

Remote diagnostics

If a fault occurs, Customer Support can use remote diagnostics to access your appliance.

Contact Customer Support, make sure that your appliance is connected to the Home Connect server and check whether the remote diagnostics service is available in your country.

Note: For more information and to check whether the remote diagnostics service is available in your country, please visit the Help & Support area of the Home Connect website for your country: www.home-connect.com

Information on Data Protection

When your appliance is connected to a WLAN network that is connected to the Internet for the first time, your appliance transmits the following categories of data to the Home Connect server (initial registration):

- Unique appliance identification (consisting of appliance codes as well as the MAC address of the installed Wi-Fi communication module).
- Security certificate of the Wi-Fi communication module (to ensure a secure data connection).

- The current software and hardware version of your appliance.
- Status of any previous resetting to factory settings.

This initial registration prepares the Home Connect functions for use and is only required when you want to use these Home Connect functions for the first time.

Note: Ensure that the Home Connect functions can be used only in conjunction with the Home Connect app. Information on data protection can be accessed in the Home Connect app.

Wi-Fi® Module

FCC/IC Statements

Model: COM2
FCC ID: 2AHES-COM2
IC ID: 21152-COM2

The Home Connect module is a communication device designed to provide communication between appliances and smart devices.

This module is integrated at the factory, under direct control of BSH Home Appliances Corporation, and is not user servicable or upgradable. At least 7⁷/₈ inch (20 cm) separation distance should be maintained from device to user.

FCC COMPLIANCE STATEMENT



CAUTION

Changes or modifications not expressly approved could void your authority to use this equipment.

This device complies with Part 15 of the FCC Rules. Operation to the following two conditions:

1. This device may not cause harmful interference, and
2. This device must accept any interference received, including interference that may cause undesired operation.

INDUSTRY CANADA STATEMENT

This device complies with Industry Canada license-exempt RSS standard(s).

Operation is subject to the following two conditions:

1. This device may not cause interference, and
2. This device must accept any interference, including interference that may cause undesired operation of the device.

Connecting an extractor hood

You can connect this appliance to a matching hood and then control the functions of the hood via your cooktop.

There are various options for connecting the appliances:

Home Connect

Two appliances can be connected using the Home Connect app provided, that both of them are Home Connect-compatible.

Refer to the Home Connect documents supplied for more information.



Connecting appliances directly

If the appliance is connected directly to a hood, it cannot be connected to your home network as well. The appliance functions in the same way as a cooktop with no network connection. The cooktop can always be operated via the control panel.

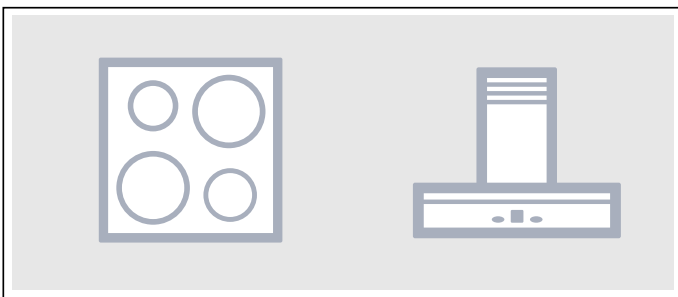

Connecting appliances via your home network

If the appliances are connected to each other via your home network, both the hood controls and Home Connect can be used to operate the cooktop.

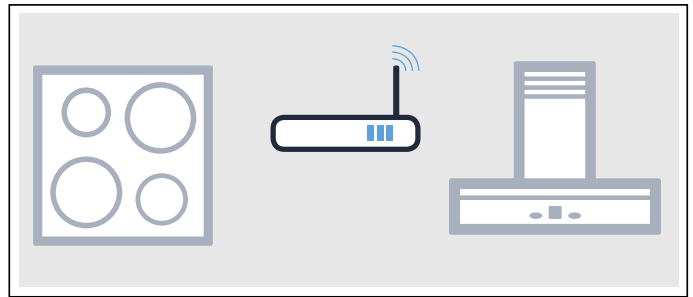

Notes

- Make sure you follow the safety instructions in the instruction manual for your hood and that these are complied with even when operating the appliance via the hood controls on the cooktop.
- If the appliance is being operated by means of the controls on the hood, this mode of operation always has priority. It is not possible to use the hood controls on the cooktop during this time.
- In networked standby mode, your appliance requires a maximum of 2 W.

Setting up a connection



To set up the connection between the cooktop and the hood, the cooktop must be switched on.

Connecting directly

Make sure that the extractor hood is switched off.

For more information, refer to the section entitled "Connecting to the cooktop" in the instruction manual for your extractor hood.

Note: If you connect your cooktop directly to the extractor hood, it cannot be connected to your home network as well and you will not be able to use Home Connect.

1. Open the basic settings.
2. Touch the  symbol repeatedly until the  setting appears.
OFF lights up on the cooking zone display.
3. Set the value to *!* using the twist knob.
! will flash on the cooking zone display.
4. You have two minutes to initiate the connection process on the extractor hood.

Once the cooktop is connected to the extractor hood, the  value appears on the cooking zone display. The



symbols for the hood controls on the cooktop are displayed on the cooktop control panel.

Connecting via your home network



You require a router that has WPS functionality.

You need to be able to access your router. If you do not have this, follow the steps for "Direct connection".

First make sure that the extractor hood is on your home network.

1. Open the basic settings.
2. Touch the  symbol repeatedly until the  setting appears.

 lights up on the cooking zone display.

3. Set the value to  using the twist knob.
 will flash on the cooking zone display.
4. Press the WPS button on the router within the next two minutes.

The cooktop is connected to the home network and the  value appears in the cooking zone display.



5. Initiate the process for connecting to the extractor hood.

Once the hob is connected to the extractor hood, the  value appears in the cooking zone display. The symbols for the hood controls on the cooktop are displayed on the cooktop control panel.

Note: Connection can only be established when both appliances are connected to your home network and the connection process has been initiated for both of them. If the connection process has already timed out for one of the two appliances, try to connect again (basic settings,  setting).

Resetting the connection

You can reset the connections you have saved for your home network and extractor hood at any time.

1. Open the basic settings.
2. Touch the  symbol repeatedly until the  setting appears.
3. Set the value to  using the twist knob.

Controlling the hood via the cooktop

In the basic settings of your cooktop, you can adjust the behavior of your extractor hood depending on the switch-on/off of the cooktop or individual cooking zones.

→ "Hood control settings" on page 52

You can select other settings using the control panel.

Setting the fan







Switching on

Touch the  symbol.

Choosing the fan setting

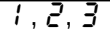

Turn the twist knob clockwise or anti-clockwise to adjust the fan setting.

The following settings are possible:

Display	Function
	Fan off
	Automatic mode The fan starts automatically when steam is produced
	Fan settings Intensity: Low, medium, high
	PowerBoost function
	Intermittent ventilation
	Fan run-on

Switching off

To switch the fan off and continue cooking:

1. Touch the  symbol.
2. Use the twist knob to select the fan setting .

To switch off the cooktop:

How the fan behaves once the cooktop is switched off depends on the basic setting you have selected.

If the  symbol is displayed, the fan is in run-on mode.

Note: Once the cooktop and fan have been switched off, the  symbol may still be faintly visible.

Setting the hood lighting

You can switch the hood light on and off via the cooktop's control panel.

Touch the  symbol.

Depending on the basic settings you have selected, the light will automatically be switched on or off when the cooktop is switched on or off. → "Hood control settings"

Hood control settings

You can adjust the cooktop-based hood controls to suit your requirements at any time.

Changing the basic settings → "Basic settings"

Display	Function
cE	Cooktop-to-hood connection
OFF	Not connected*/disconnect.
1	Connect.
2	Connected to home network.
ON	Connected to extractor hood.
cR	Automatic fan switch-on
OFF	Switched off. The hood will need to be switched on manually if required.
R	Switched on in automatic mode.* In automatic mode, the hood switches itself on when you switch on one of the cooking zones.
1	Switched on in manual mode. The hood switches itself on at the lowest setting when one of the cooking zones is switched on.
2	Switched on in manual mode. The hood switches itself on at a medium setting when one of the cooking zones is switched on.
3	Switched on in manual mode. The hood switches itself on at the highest setting when one of the cooking zones is switched on.
cb	Fan run-on
OFF	The fan switches itself off when the cooktop is switched off.
R	Switched on in automatic mode.*
ON	Switched on with standard fan run-on.
ND	Settings cannot be changed.
cc	Switch light on automatically
OFF	Switched off.*
ON	Switched on. The light switches itself on when you switch on the cooktop.
cd	Switching off the light automatically
OFF	Switched off.*
ON	Switched on. The light switches itself off when you switch off the cooktop.

* Basic setting

Note: The *cR*, *cb*, *cc* and *cd* settings are only displayed if the appliance is connected to an extractor hood.

Clean

Daily Cleaning

Note: Recommended cleaners indicate a type of cleaner and do not constitute an endorsement of a specific brand.

Glass ceramic cooktop

CAUTION

Do not use any kind of cleaner on the glass while the surface is hot; use only the razor blade scraper. The resulting fumes can be hazardous to your health. Heating the cleaner can chemically attack and damage the surface.

Clean the surface when it is completely cool, with the following exception: remove dry sugar, sugar syrup, tomato products and milk immediately with the razor blade scraper (see cleaning chart).

Wipe off spatters with a clean, damp sponge or a paper towel. Rinse and dry. Use white vinegar if smudge remains; rinse.

Cleaning chart

Type of Soil	Possible Solution
Dry sugar, sugar syrup, milk or tomato spills. Melted plastic film or foil. All these items REQUIRE IMMEDIATE REMOVAL. Failure to remove these immediately can permanently damage the surface.	Remove these types of spills while the surface is hot using the razor blade scraper. Use a new, sharp razor in the scraper. Remove pan and turn off the element. Wearing an oven mitt, hold scraper at 30° angle, using care not to gouge or scratch the glass. Push soil off the heated area. After the surface has cooled, remove the residue and apply the glass ceramic cooktop cleaner.
	<hr/> <h4> WARNING</h4> <p>Risk of injury! The blade is extremely sharp. Risk of cuts. Protect the blade when not in use. Replace the blade immediately when any imperfections are found. Follow manufacturer's instructions.</p> <hr/>
Burned-on food soil, dark streaks, and specks	Soften by laying a damp paper towel or sponge on top of soil for 30 minutes. Use a plastic scrubber and glass ceramic cooktop cleaner or use the razor blade scraper. Rinse and dry.

Apply a small amount of the glass ceramic cooktop cleaner. When dry, buff surface with a clean paper towel or cloth.

Cleaning guidelines

When using a cleaner, use only a small amount; apply to a clean paper towel or cloth. Wipe on the surface and buff with a clean dry towel.

For best results, use cleaners such as glass ceramic cooktop cleaner, BonAmi®, Soft Scrub® (without bleach), and white vinegar.

Avoid these cleaners

- Glass cleaners which contain ammonia or chlorine bleach. These ingredients may damage or permanently stain the cooktop.
- Caustic cleaners - cleaners such as Easy Off® may stain the cooktop surface.
- Abrasive cleaners.
- Metal scouring pads and scrub sponges such as Scotch Brite® can scratch and/or leave metal marks.
- Soap-filled scouring pads such as SOS® can scratch the surface.
- Powdery cleaners containing chlorine bleach can permanently stain the cooktop.
- Flammable cleaners such as lighter fluid or WD-40.

Type of Soil	Possible Solution
Greasy spatters	Use a soapy sponge or cloth to remove grease; rinse thoroughly and dry. Apply glass ceramic cooktop cleaner.
Metal marks: Iridescent stain	Pans with aluminum, copper or stainless steel bases may leave marks. Treat immediately after surface has cooled with glass ceramic cooktop cleaner. If this does not remove the marks, try a mild abrasive (Bon Ami®, Soft Scrub® without bleach) with a damp paper towel. Rinse and reapply glass ceramic cooktop cleaner. Failure to remove metal marks before the next heating makes removal very difficult.
Hard water spots: Hot cooking liquids dripped on surface	Minerals in some water can be transferred onto the surface and cause stains. Use undiluted white vinegar, rinse and dry. Recondition with glass ceramic cooktop cleaner. Remove boilovers and stains before using the cooktop again.
Surface scratches: Small scratches are common and do not affect cooking. They become smoother and less noticeable with daily use of the glass ceramic cooktop cleaner.	Apply glass ceramic cooktop cleaner before using to remove sand-like grains and grit such as salt and seasoning. Scratches can be reduced by using pans with bases that are smooth, clean, and dry before use. Use recommended glass ceramic cooktop cleaner daily.
NOTICE	
Diamond rings may scratch the surface.	

Twist knob

The twist knob is best cleaned using lukewarm soapy water. Do not use harsh or abrasive cleaning agents. Do not clean the twist knob in the dishwasher or using rinsing water. This may damage it.

Maintenance

This appliance requires no maintenance other than daily cleaning. For best results, apply cooktop cleaning cream daily.

Using the appliance

Why can't I switch on the cooktop and why is the child lock symbol lit?

The child lock is activated. Place the twist knob on the twistpad.

You can find information about this function in section → *"Childproof lock"*

Why can I hear an audible signal?

Remove any liquid or food remains from the control panel. Remove any objects from the control panel.

You can find instructions on how to deactivate the audible signal in the section on → *"Basic settings"*

Noises

Why can I hear noises while I'm cooking?

Noises may be generated while using the cooktop depending on the base material of the cookware. These noises are a normal part of induction technology. They do not indicate a problem.

Possible noises:

A low humming noise like the one a transformer makes:

Occurs when cooking at a high heat setting. The noise disappears or becomes quieter when the heat setting is reduced.

Noises

Low whistling noise:

Occurs when the cookware is empty. This noise disappears when water or food is added to the cookware.

Crackling:

Occurs when using cookware made from different layers of material or when using cookware of different sizes and different materials at the same time. The volume of the noise can vary depending on the quantity of food being cooked or the cooking method.

High-pitched whistling noises:

Can occur when two elements are used on the highest heat setting at the same time. The whistling noises disappear or become quieter when the heat setting is reduced.

Fan noise:

The cooktop is equipped with a fan that switches on automatically at high temperatures. The fan may continue to run even after you have switched off the cooktop if the temperature detected is still too high.

Cookware

Which types of cookware can be used with an induction hob?

For information on which types of cookware can be used with an induction hob, see the section entitled.

Why is the cooking zone not heating up and why is the heat setting flashing?

The cooking zone on which the cookware has been placed is not switched on.

Check that the cooking zone on which the cookware has been placed is switched on.

The cookware is too small for the cooking zone that is switched on or it is not suitable for induction cooking.

Check that the cookware is suitable for induction cooking and that it is placed on the cooking zone that best corresponds to its size. For information on the type, size and positioning of the cookware, see sections ,
 → *"Flex function"* and → *"Transfer function"*.

Why is it taking so long for the cookware to heat up or why is it not heating up sufficiently despite being at a high power level?

The cookware is too small for the cooking zone that is switched on or it is not suitable for induction cooking.

Check that the cookware is suitable for induction cooking and that it is placed on the cooking zone that best corresponds to its size. For information on the type, size and positioning of the cookware, see sections ,
 → *"Flex function"* and → *"Transfer function"*.

How do you switch on the two-ring and three-ring cooking zones?

These cooking zones can detect cookware of different sizes. The cooking zone automatically activates the one-, two- or three-ring cooking zone, depending on the material and characteristics of the cookware. This ensures that the right amount of heat is supplied in order to achieve good cooking results.

Cookware that corresponds to the size of the cooking zone and has a fully ferromagnetic base is most suitable. For information about which type of cookware is suitable for induction cooking, see the section entitled.

Cleaning

How do I clean the cooktop?

Using a special glass-ceramic cleaning agent produces the best results. We advise against using harsh or abrasive cleaning agents, dishwasher detergent (concentrated) or scouring pads.

You can find more information about cleaning and caring for your cooktop in the section on → *"Clean"*

Faults – what to do?

Generally, faults are easy to remedy. Please read the notes in the table before calling Customer Service.

CAUTION

Repairs should only be done by an authorized servicer.

Improper repair of your appliance may result in risk of severe physical injury or death.

Display	Possible cause	Solution
None	The power supply has been disconnected. The device has not been connected as shown in the circuit diagram. Electronics fault.	Use other electrical appliances to check whether a short-circuit has occurred in the power supply. Make sure that the appliance has been connected as shown in the circuit diagram. If you are unable to rectify the fault, inform the technical customer service.
The displays flash.	The control panel is damp or there is something on it.	Dry the control panel or remove the object.
<i>F2 / E8207</i>	The electronics have overheated and switched off the affected cooking zone.	Wait until the electronics have cooled down sufficiently. Then touch any symbol on the cooktop.
<i>F4 / E8208</i>	The electronics have overheated and all the cooking zones have been switched off.	
<i>F2 / E70 15</i>	The electronics have overheated and have switched off the affected cooking zone.	Wait until the electronics have cooled down sufficiently. Then touch any key on the cooktop.
<i>F4 / E70 15</i>	The electronics have overheated and all the cooking zones have been switched off.	
<i>F5</i> + heat setting and audible signal	There is hot cookware near the control panel. There is a risk that the electronics will overheat.	Remove the cookware that is causing the problem. The fault display goes out shortly afterwards. You can continue the cooking process.
<i>F5</i> and audible signal	There is hot cookware near the control panel. The cooking zone has been switched off to protect the electronics.	Remove the saucepan. Wait a few seconds. Touch any touch control. When the fault display goes out, you can continue cooking.
<i>F1 / F6</i>	The cooking zone has overheated and has been switched off to protect the work surface.	Allow the electronics to cool down sufficiently and switch the cooking zone on again.
<i>F0</i>	The transfer settings function cannot be activated.	Confirm the fault display by touching any sensor. You can cook as usual without using the settings transfer function. Inform the technical customer service.
<i>F8</i>	The cooking zone has been operating continuously for an extended period.	The automatic safety switch-off function has been activated. See the section entitled
<i>E70 10</i>	The cooktop is unable to connect to your home network or the hood.	Acknowledge the fault code by touching any of the touch keys. You can cook as usual without a connection. If this code is displayed again, contact Customer Support.
<i>E8202</i>	The temperature sensor has overheated and the cooking zone has been switched off.	Wait until the cooking sensor has cooled down sufficiently before activating the function again.

Do not place hot cookware on the control panel.

Display	Possible cause	Solution
<i>E8203</i>	The temperature sensor has overheated and all the cooking zones have been switched off.	When you are not using the temperature sensor, remove this from the cookware and store it far away from the cooking zones or heat sources. Switch the cooking zones back on.
<i>E8204</i>	The battery in the temperature sensor is flat.	Replace the 3 V CR2032 battery. See the section entitled "Changing the battery".
<i>E8205</i>	The temperature sensor is no longer connected.	Switch the function off and then on again.
<i>E8206</i>	The temperature sensor is broken/faulty.	Inform the technical customer service.
The temperature sensor display does not light up.	The temperature sensor does not react and the display does not light up.	Replace the 3 V CR2032 battery. See the section entitled "Changing the battery". If this does not solve the problem, press and hold the symbol on the temperature sensor for eight seconds and then reconnect the temperature sensor to the cooktop. If the problem still persists, contact the technical customer service.
The indicator on the temperature sensor flashes twice.	The battery in the temperature sensor has almost run out. You may be interrupted the next time you cook by the battery running out.	Replace the 3 V CR2032 battery. See the section entitled "Changing the battery".
The indicator on the temperature sensor flashes three times.	The temperature sensor is no longer connected.	Press and hold the symbol on the temperature sensor for eight seconds and then reconnect the temperature sensor to the cooktop.
<i>E9000</i> <i>E90 10</i>	The operating voltage is incorrect and outside of the normal operating range.	Contact your electricity supplier.
<i>U400</i>	The cooktop is not connected properly.	Disconnect the cooktop from the mains power supply. Make sure that it has been connected as shown in the circuit diagram.
<i>dE</i>	Demo mode is activated.	Disconnect the cooktop from the mains power supply. Wait 30 seconds and then reconnect. Touch any touch control within the next three minutes. Demo mode is switched off.

Do not place hot cookware on the control panel.

Notes

- If *E* appears on the display, the sensor for the element in question must be held down in order to be able to read the fault code.
- If the fault code is not listed in the table, disconnect the cooktop from the power supply, wait 30 seconds, and then reconnect it again. If the display appears again, contact Customer Support and tell them the precise fault code.
- If a fault occurs, the appliance will not switch to standby mode.

Cookware Test

This function can be used to check the speed and quality of the cooking process depending on the cookware.

The result is a reference value and depends on the properties of the cookware and the element being used.

1. With the cookware still cold, fill it with approx. 200 ml of water and place it on the center of the element with the diameter that most closely matches that of the base of the cookware.
2. Go to the basic settings and select the *7* setting.
3. Touch the settings range. – will flash on the element display.

The function has now been activated.

After 10 seconds, the result for the quality and speed of the cooking process will appear on the element display.

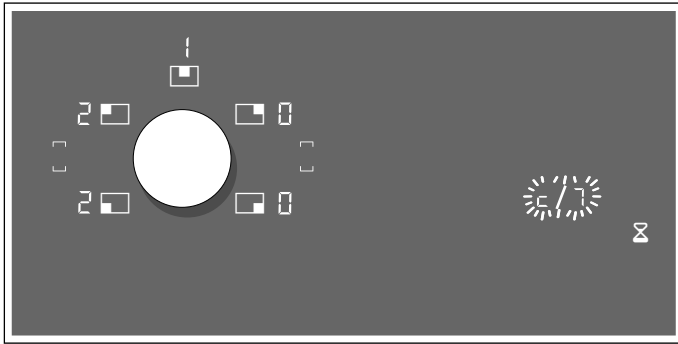

Check the result using the table below:

Result	
	The cookware is not suitable for the element and will therefore not heat up.*
	The cookware is taking longer to heat up than expected and the cooking process is not going as well as it ought to.*
	The cookware is heating up correctly and cooking is progressing well.

* If there is a smaller element available, try the cookware again on the smaller element.

To reactivate the function, turn the twist knob.

Notes

- The flexible cooking zone only counts as a single cooking zone; place no more than one item of cookware on it.
- If the diameter of the cooking zone that is used is much smaller than the diameter of the cookware, only the middle of the cookware can be expected to heat up. This may result in the cooking results not being as good as expected or not being satisfactory.
- You can find information on this function in the section entitled → "Basic settings".
- You can find information on the type, size and positioning of the cookware in the sections entitled and → "Flex function".

Customer Service

If your appliance needs repairs, our Customer Service is there for you. We work hard to help solve problems quickly and without unnecessary service calls, getting your appliance back up and running correctly in the least amount of time possible.

When you call, please indicate the product number (E-Nr.) and serial number (FD-Nr.) so that we can support you in a qualified manner. You will find the data plate with these numbers on the bottom of the appliance. To avoid having to search when you need it, you can enter your appliance data and the Customer Service telephone number here.

E-Nr.	FD-Nr.
Customer Service	

Please read the use and care instructions provided with your appliance. Failure to do so may result in an error in using the appliance resulting in unnecessary service calls, which may not be covered by the warranty.

Please find the contact data of all countries in the enclosed customer service list.

To book a service visit and product advice

USA	877 442 4436 toll-free
CANADA	877 442 4436 toll-free

Gaggenau
BSH Home Appliance Corporation
1901 Main Street, Suite 600
Irvine, CA 92614
1-877-442-4436

www.gaggenau.com/us
© 2018 BSH Home Appliances

Gaggenau Hausgeräte GmbH
Carl-Wery-Straße 34
81739 München
GERMANY



9001390824 (990118)

en-us

GAGGENAU