

### CWEH9-454

Halogen lights. WL-1 warming lights are available on selected models. Shown with optional duct covers (sold separately). Optional duct covers are available in standard and custom sizes.

#### Dimensional Information

Width	54.0
Depth	21.0
Height	9.0
CFM @ 0.0" SP	1200.0
Sones	6.6
Amps	7.8
# Lights	4.0

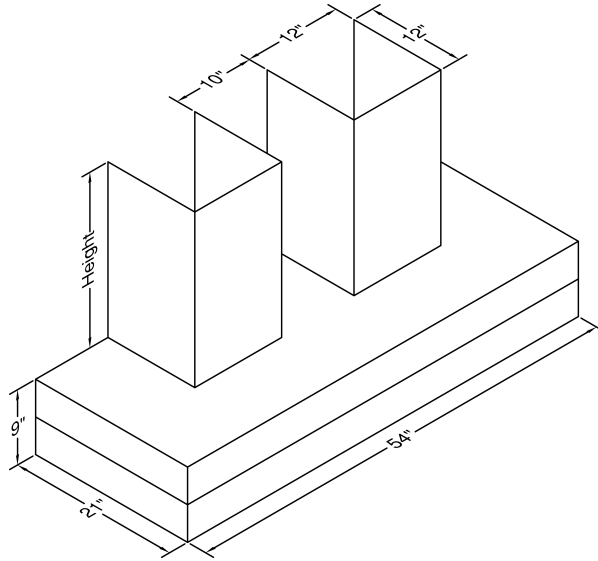

#### Recommended Mounting Height\*

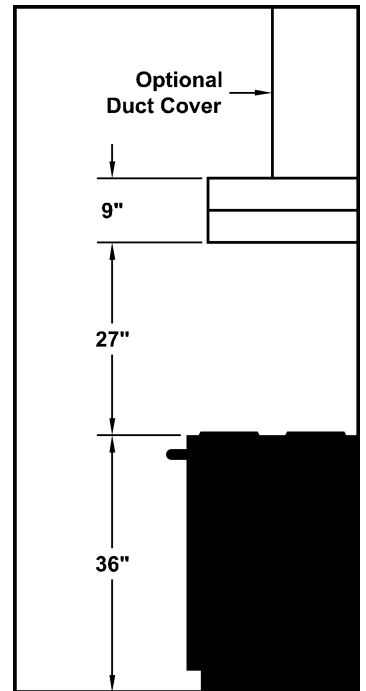

\*Exceeding recommended mounting height may compromise performance.

#### Connection Diagram

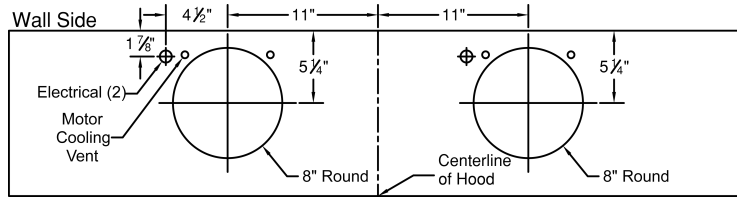

1200 CFM Double B200 Dual Blowers (Top View)

#### Electrical/Mechanical Specifications For Blower Unit

Model	Volts	Amps*	Hz	RPM	CFM SP@0.0"	Equivalent CFM	CFM SP@0.1"	CFM SP@0.2"	CFM SP@0.3"	Minimum Round Duct Size	Sones#
Two B200 Duals	115.0	5.8	60.0	1550.0	1200.0	1800.0	1062.0	960.0	860.0	12" (113 sq. in.)	6.6

+This model is equipped with halogen lighting: (2 lights: 30" - 41", 3 lights: 42" - 53", 4 lights: 54" - 66").

\$ Because the Magic Lung® blower uses centrifugal filtration rather than conventional baffle or mesh filters, the Magic Lung® blower can handle cooking equipment with higher cubic feet per minute (CFM) requirements and can deliver equivalent CFM much more efficiently than other filtration systems. When comparing the Magic Lung® with other blower units made by other manufacturers, use the "Equivalent CFM".

# Ratings in accordance with the Standard Test Code by the Energy Systems Laboratory of the Texas Engineering Experiment Station.