

**audio-technica**

## ■ Features

- Ideal, cost-effective solution for huddle rooms, conference rooms and other meeting spaces
- Quad-capsule steerable microphone array designed for use with the ATDM-0604 Digital SMART MIX™ and other compatible mixers
- When controlled by a compatible mixer, provides 360° coverage from a potentially limitless number (bound by mixer channel count) of virtual hypercardioid or cardioid pickups that can be steered in 30° increments to clearly capture every person speaking in a room by using original synthetic technology (PAT.).
- Mixer-controlled tilt function provides a vertical steering option to accommodate ceilings of different heights
- Includes Plenum-rated AT8554 Ceiling Mount with RJ45 connectors and push-type wire terminals for simple, secure installation with seismic cable to secure to a drop ceiling grid
- Integral, logic-controlled red/green LED ring provides clear indication of mute status
- High-output design with low self-noise delivers strong, natural-sounding vocal reproduction
- Low-reflective white finish matches ceiling tiles in most environments
- Includes two 46 cm (18") breakout cables: RJ45 (female) to three 3-pin Euroblock connector (female), RJ45 (female) to 3-pin Euroblock connector (female) and unterminated LED conductors
- Permanently attached 1.2 m (4') cable with locking grommet enables quick microphone height adjustment
- UniGuard™ RFI-shielding technology offers outstanding rejection of radio frequency interference (RFI)
- Requires 11 V to 52 V DC phantom power

## ■ Trademarks

- SMART MIX™ are trademark of Audio-Technica Corporation, registered in the U.S. and other countries.
- UniGuard™ are trademark of Audio-Technica Corporation, registered in the U.S. and other countries.

## ■ Introduction

Thank you for purchasing this product. Before using the product, read through the user manual to ensure that you will use the product correctly.

## ■ Safety precautions

Although this product was designed to be used safely, failing to use it correctly may result in an accident. To ensure safety, observe all warnings and cautions while using the product.

## ■ Cautions for the product

- Do not subject the product to strong impact to avoid malfunction.
- Do not disassemble, modify or attempt to repair the product.
- Do not handle the product with wet hands to avoid electric shock or injury.
- Do not store the product under direct sunlight, near heating devices or in a hot, humid or dusty place.
- Do not install the product close to air conditioner or lighting apparatus to prevent malfunction.
- Do not pull on the product with excessive force nor hang on it after it is installed.

## ■ Connection

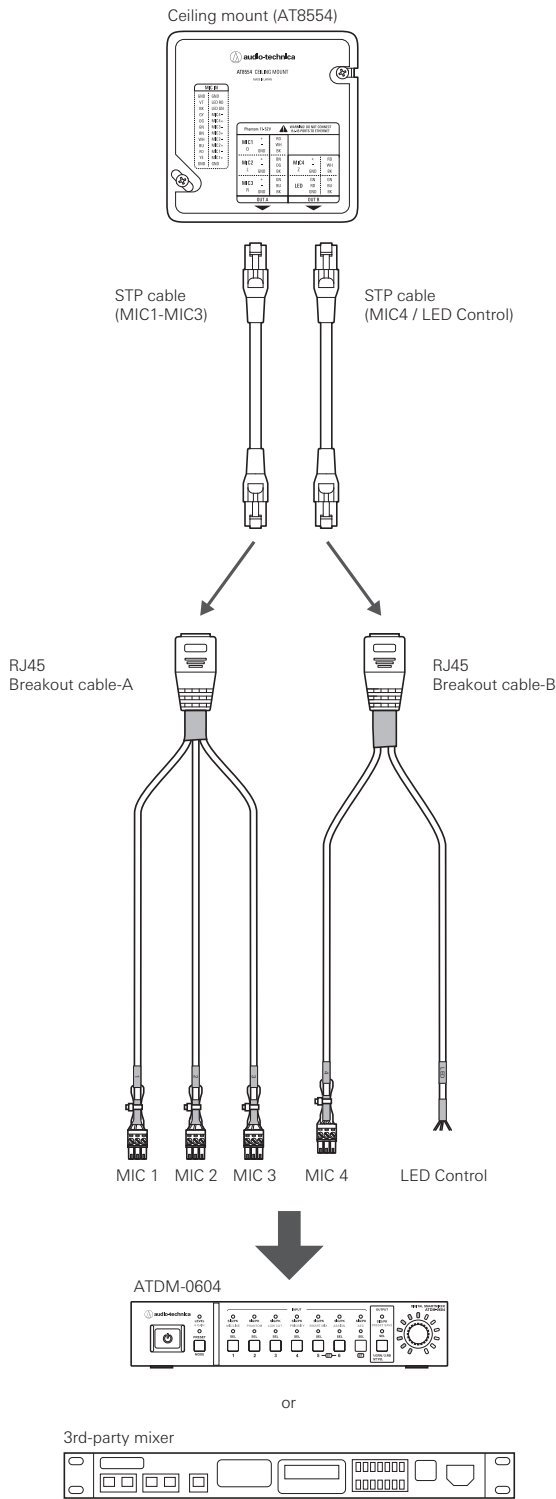

Connect the output terminals of the microphone to a device that has a microphone input (balanced input) compatible with a phantom power supply. The output connector is a Euroblock connector with polarity as shown in the figure below. Use STP cables to connect from the mounting box RJ45 jacks to breakout cables.

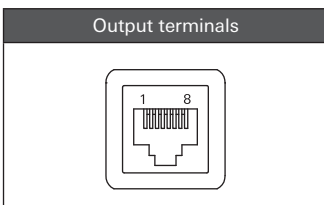

The product requires 11V to 52V DC phantom power for operation.

## ■ Wiring Chart

	RJ45 connector pin number	Function	RJ45 breakout cable wire color
OUT A	1	MIC2 L(+)	BROWN
	2	MIC2 L(-)	ORANGE
	3	MIC3 R(+)	GREEN
	4	MIC1 O(-)	WHITE
	5	MIC1 O(+)	RED
	6	MIC3 R(-)	BLUE
	7	GND	BLACK
	8	GND	BLACK
OUT B	1	BLANK	-
	2	BLANK	-
	3	LED GREEN	GREEN
	4	MIC4 Z(-)	WHITE
	5	MIC4 Z(+)	RED
	6	LED RED	BLUE
	7	GND	BLACK
	8	GND	BLACK

- Output from the microphone is low impedance (Lo-Z) balanced. The signal appears across the pair of each output Euroblock connectors on the RJ45 breakout cables. Audio ground is the shield connection. Output is phased so that positive acoustic pressure produces positive voltage on the left side of each Euroblock connector.
- MIC1 is "O" (omnidirectional), MIC2 is "L" (figure-of-eight) positioned horizontally at 240°, MIC3 is "R" (figure-of-eight) positioned horizontally at 120°, and MIC4 is "Z" (figure-of-eight) positioned vertically.

## ■ Pin assignment

MIC 1		O + O - GND
MIC 2		L + L - GND
MIC 3		R + R - GND
MIC 4		Z + Z - GND
LED Control		LED GREEN LED RED GND

## ■ LED control

- To control the LED indicator ring, connect the LED Control terminals of the RJ45 breakout cable to the GPIO port of the automatic mixer or other logic device.
- When using the product with a mixer with no GPIO terminal, the LED ring can be kept permanently lit by connecting the black (BK) or violet (VT) wire to the GND terminal. When the black wire is shorted, the LED ring will be green. When the violet wire is shorted, the LED ring will be red.

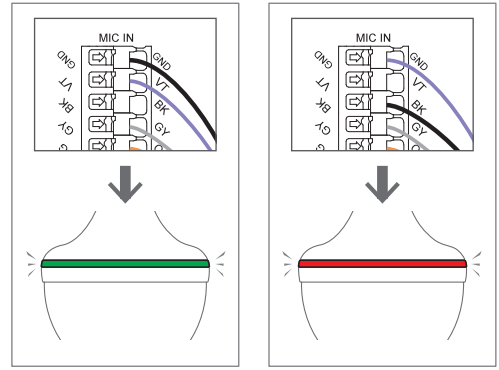
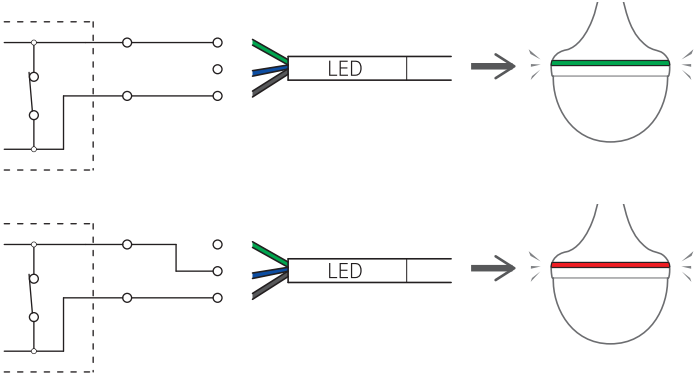

## Parts, name and installation

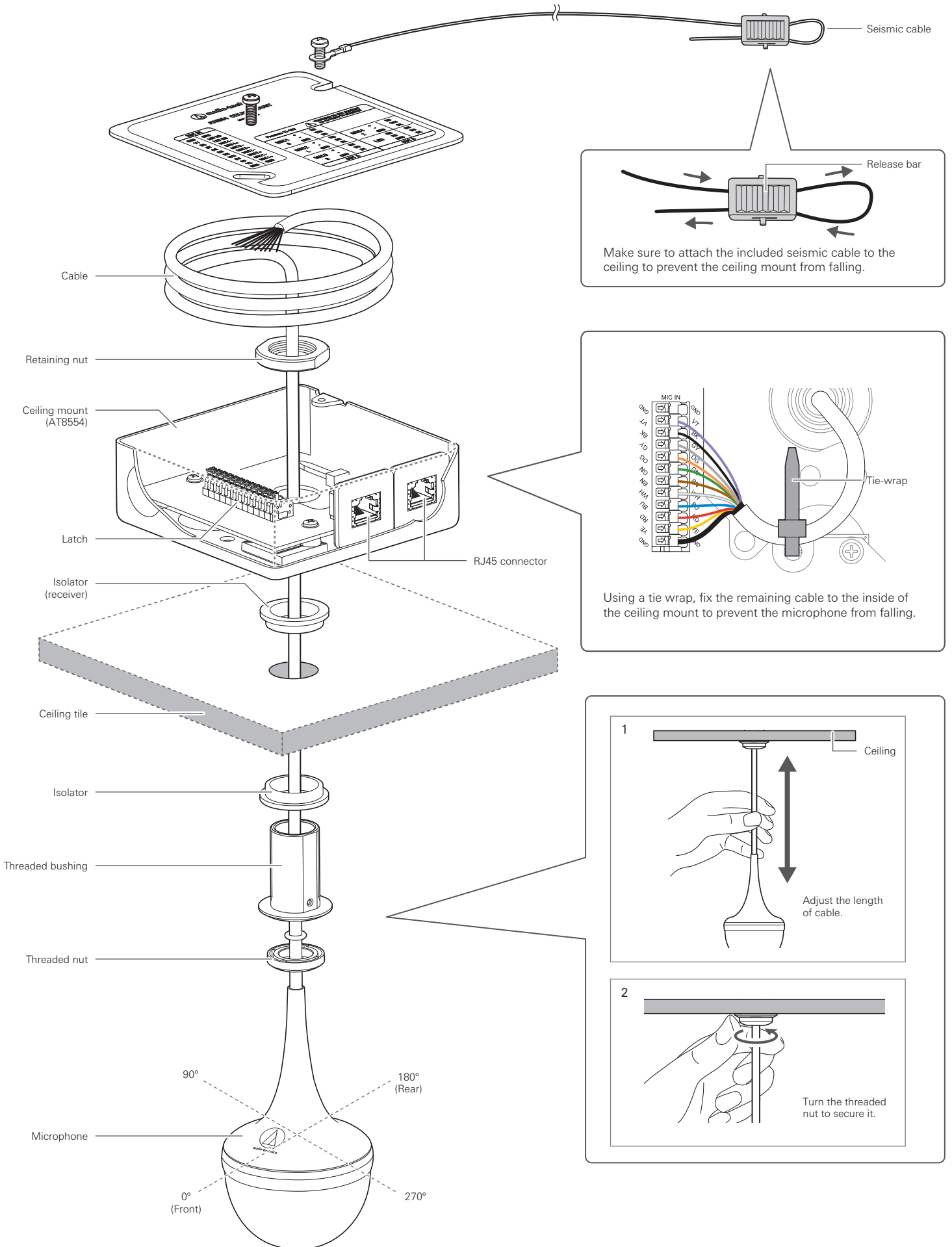

## ■ Notices

- When installing the product, a hole must be cut into the ceiling tile so the ceiling mount can be fixed in place. Remove the ceiling tile first if possible.
- To mount the threaded bushing in a ceiling tile without the isolators:  
20.5 mm (0.81") diameter hole is required and the ceiling tile can be up to 22 mm (0.87") thick.
- To mount the threaded bushing with the isolators:  
23.5 mm (0.93") hole is required and the ceiling tile can be up to 25 mm (0.98") thick. Place the isolators on either side of the hole to achieve mechanical isolation from the mounting surface.

## ■ Installation

1. Remove the backplate of the ceiling mount and place it against the back of the ceiling tile, allowing the threaded bushing to pass through.
2. Once in place, thread the retaining nut onto the threaded bushing, securing the ceiling mount to the ceiling tile.
3. Connect the microphone cable to the terminal connector on the ceiling mount by pressing down the orange tabs on the terminal strip.
4. Once all connections are made, secure the microphone cable to the PCB using the included wire tie.
5. Adjust the cable to desired microphone height by either feeding or pulling the cable through the ceiling mount.
6. Once the microphone is in the desired position, gently turn the threaded nut clockwise to secure. (Do not over tighten and pull the cable strongly).
7. Coil the excess cable into the ceiling mount and replace the backplate.

## ■ Recommended position

Change the height and tilt position according to the environment in which you use the product.

Tilt \ MIC position	Minimum Height	Typical Height	Maximum Height
Tilt up	1.2 m (4')	1.75 m (5.75')	2.3 m (7.5')
Tilt down	1.7 m (5.6')	2.2 m (7.2')	2.7 m (9')

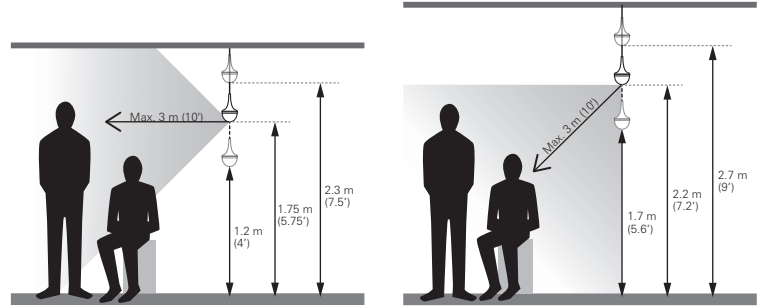

## ■ Coverage examples

- For 360° coverage, create four hypercardioid (normal) virtual polar patterns at the 0°, 90°, 180°, 270° positions. This setting is ideal for providing omnidirectional coverage of four people around a round table (see Figure. A).
- For 300° coverage, create three cardioid (wide) virtual polar patterns at the 0°, 90°, 180° positions. This setting is ideal for covering three people at the end of a rectangular table (see Figure. B).
- For installation of two or more units, we recommend that you install them at a distance of at least 1.7 m (5.6') (for hypercardioid (normal)) so that the coverage ranges of the microphones do not overlap (see Figure. C).

Figure A

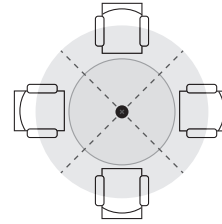

Figure B

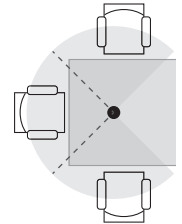
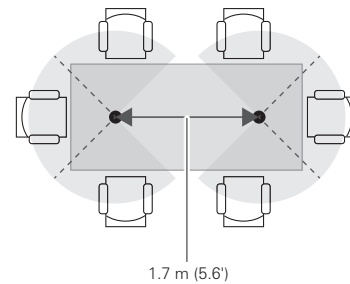

Figure C



## ■ Using the product with the ATDM-0604 Digital SMART MIX™

For the firmware of ATDM-0604, please use Ver1.1.0 or later.

1. Connect Mic 1-4 of the product to input 1-4 on the ATDM-0604. Launch the ATDM-0604 Web Remote, select "Administrator", and log in.
2. Click the icon (👤) on the top right of the screen then select Audio>Audio System. Activate "Virtual Mic Mode". This will automatically turn the first 4 channels of the ATDM-0604 into virtual polar patterns created from the input of the product.

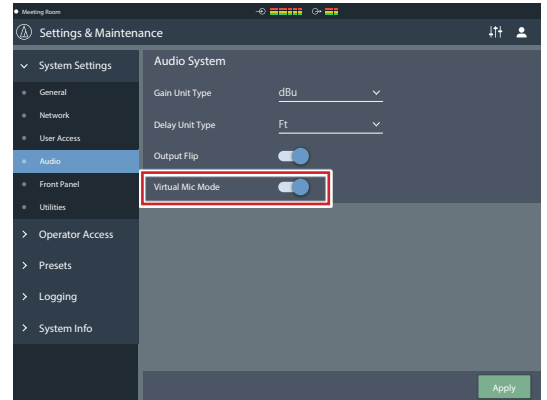

## ■ In Setting & Maintenance Operator Access / Operator Page

Once "Virtual Mic Mode" is activated there will be an option to show or hide the "Array Mic Off" button on the operator page. This button allows the operator to mute the mic and turn off the LED ring from the operator page for temporary mute.

- This setting is not saved on the device, so rebooting the ATDM-0604 restores it to its default "Mic On" position.

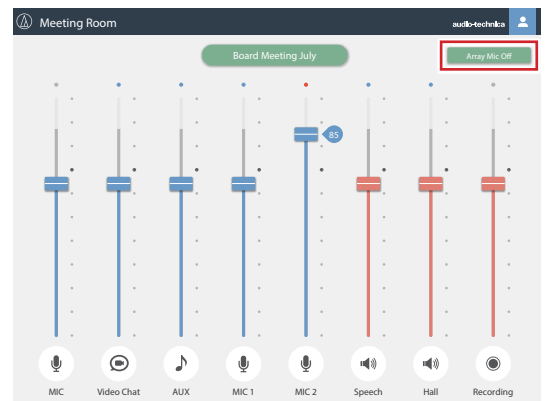
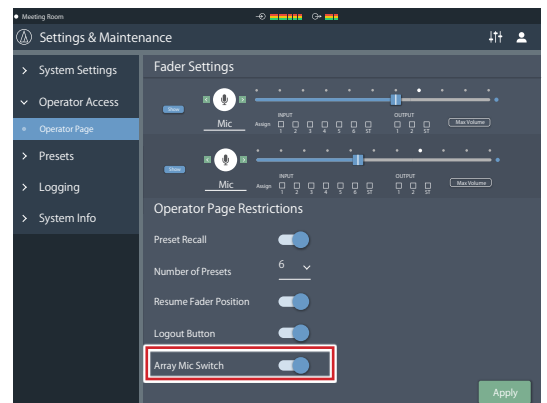





## ■ On the main Administrator page click on the input tab

1. Switch the input of the first 4 channels to Virtual Mic.
2. Adjust the gain to the required level. (a)
  - Setting the input gain on one channel will simultaneously change it on all four channels. Low cut, EQ, Smart Mixing and routing can individually be assigned for each channel or "Virtual Mic".
3. Clicking on the side of the Virtual Mic box (b) opens the settings tab for the directivity lobe. These can be adjusted between "Normal" (hypercardioid), "Wide" (cardioid) and "Omni".
4. Clicking the blue button around the circle sets the orientation of each Virtual Mic.
5. Adjust the Virtual Mic. direction towards the source to be picked up.
  - The Audio-Technica logo is located on the front of the microphone. The microphone must be oriented correctly to operate properly.
6. Using the "Tilt" function, you can adjust the directivity on the vertical plane to adjust the angle depending on whether the talker is sitting or standing.
7. Adjust the individual volume of each Virtual Mic using the Volume Fader.

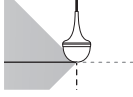
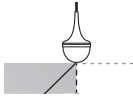
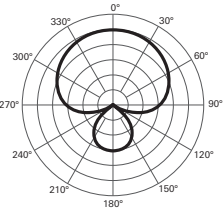
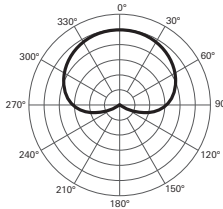

## ■ Using with other compatible mixer

When connecting and using the product with a mixer other than the ATDM-0604, directivity can be controlled by adjusting the output of each channel according to the following mixing matrix.

Mixing matrix	Normal 		Wide 						
Tilt up 	Directivity direction	O		L		R		Z	
		$\phi$	Level	$\phi$	Level	$\phi$	Level	$\phi$	Level
	0°	+	-4dB	-	0dB	-	0dB		-∞
	30°	+	-4dB	-	+1.2dB	-	-4.8dB		-∞
	60°	+	-4dB	-	0dB		-∞		-∞
	90°	+	-4dB	-	-4.8dB	+	-4.8dB		-∞
	120°	+	-4dB		-∞	+	0dB		-∞
	150°	+	-4dB	+	-4.8dB	+	+1.2dB		-∞
	180°	+	-4dB	+	0dB	+	0dB		-∞
	210°	+	-4dB	+	+1.2dB	+	-4.8dB		-∞
	240°	+	-4dB	+	0dB		-∞		-∞
	270°	+	-4dB	+	-4.8dB	-	-4.8dB		-∞
	300°	+	-4dB		-∞	-	0dB		-∞
330°	+	-4dB	-	-4.8dB	-	+1.2dB		-∞	
Tilt down 	Directivity direction	O		L		R		Z	
		$\phi$	Level	$\phi$	Level	$\phi$	Level	$\phi$	Level
	0°	+	-4dB	-	-3dB	-	-3dB	+	-3dB
	30°	+	-4dB	-	-1.8dB	-	-7.8dB	+	-3dB
	60°	+	-4dB	-	-3dB		-∞	+	-3dB
	90°	+	-4dB	-	-7.8dB	+	-7.8dB	+	-3dB
	120°	+	-4dB		-∞	+	-3dB	+	-3dB
	150°	+	-4dB	+	-7.8dB	+	-1.8dB	+	-3dB
	180°	+	-4dB	+	-3dB	+	-3dB	+	-3dB
	210°	+	-4dB	+	-1.8dB	+	-7.8dB	+	-3dB
	240°	+	-4dB	+	-3dB		-∞	+	-3dB
	270°	+	-4dB	+	-7.8dB	-	-7.8dB	+	-3dB
	300°	+	-4dB		-∞	-	-3dB	+	-3dB
330°	+	-4dB	-	-7.8dB	-	-1.8dB	+	-3dB	
Polar pattern									
	LEGEND 1kHz  SCALE IS 5 DECIBELS PER DIVISION		LEGEND 1kHz  SCALE IS 5 DECIBELS PER DIVISION						

## Specifications

Elements	Fixed-charge back plate, permanently polarized condenser
Polar pattern	Omnidirectional (O) / Figure-of-eight (L/R/Z)
Frequency response	20 to 16,000 Hz
Open circuit sensitivity	O/L/R: -36 dB (15.85 mV) (0 dB=1 V/Pa, 1 kHz); Z: -38.5 dB (11.9 mV) (0 dB=1 V/Pa, 1 kHz)
Impedance	100 ohms
Maximum input sound level	O/L/R: 132.5 dB SPL (1 kHz THD1%); Z: 135 dB SPL (1 kHz THD1%)
Signal-to-noise ratio	O/L/R: 66.5 dB (1 kHz at 1 Pa, A-weighted) Z: 64 dB (1 kHz at 1 Pa, A-weighted)
Phantom power requirements	11 - 52 V DC, 23.2 mA (all channels total)
Weight	Microphone: 160 g (5.6 oz) Mountbox (AT8554): 420 g (14.8 oz)
Dimensions (Microphone)	Maximum body diameter: 61.6 mm (2.43"); Height: 111.8 mm (4.40")
(Ceiling mount (AT8554))	36.6 mm (1.44") x 106.0 mm (4.17") x 106.0 mm (4.17") (HxWxD)
Output connector	Euroblock connector
Accessories	Ceiling mount (AT8554), RJ45 breakout cable x 2, Seismic cable, Isolator

• 1 Pascal = 10 dynes/cm<sup>2</sup> = 10 microbars = 94 dB SPL

For product improvement, the product is subject to modification without notice.

## Polar pattern / Frequency response

### Omnidirectional (O)

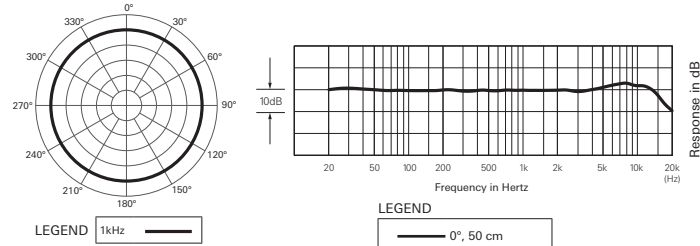

SCALE IS 5 DECIBELS PER DIVISION

### Figure-of-eight (L/R/Z)

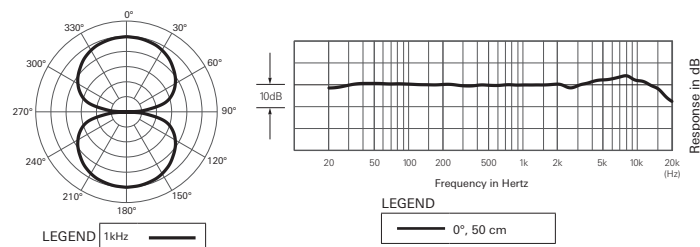

SCALE IS 5 DECIBELS PER DIVISION

## Dimensions

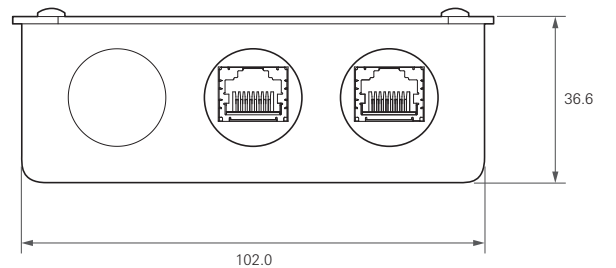
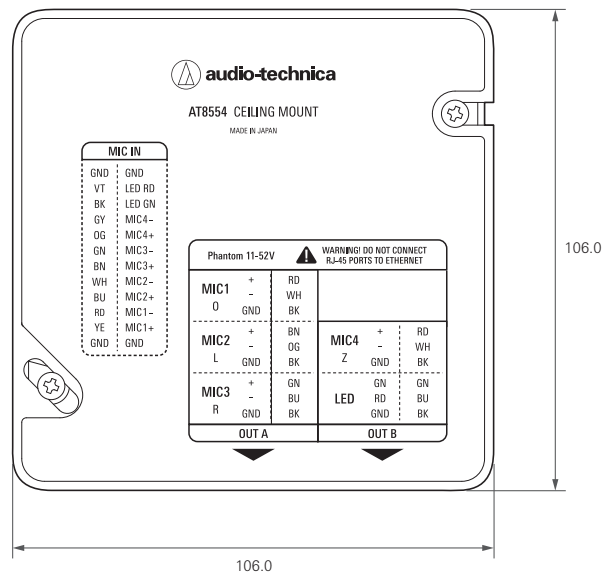
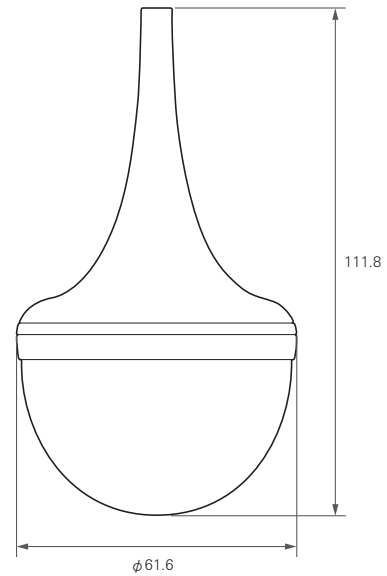

(Unit: mm)

Audio-Technica Corporation

2-46-1 Nishi-naruse, Machida, Tokyo 194-8666, Japan

©2019 Audio-Technica Corporation

Global Support Contact: [www.at-globalsupport.com](http://www.at-globalsupport.com)

Made in Japan