



# 4K HDR 4x4 HDMI to HDMI Matrix Switcher



AT-HDR-H2H-44MA

Atlona Manuals  
4x4 HDMI Switcher

## Version Information

---

Version	Release Date	Notes
1	June 2018	Initial release
2	May 2019	Added note for new front panel OSD to <a href="#">Panel Description</a>
3	Dec 2019	Added <a href="#">USB Updating</a> instructions

## Welcome to Atlona!

---

Thank you for purchasing this Atlona product. We hope you enjoy it and will take a extra few moments to register your new purchase.

Registration only takes a few minutes and protects this product against theft or loss. In addition, you will receive notifications of product updates and firmware. Atlona product registration is voluntary and failure to register will not affect the product warranty.

To register your product, go to <http://www.atlona.com/registration>

## Sales, Marketing, and Customer Support

---

### Main Office

Atlona Incorporated  
70 Daggett Drive  
San Jose, CA 95134  
United States

Office: +1.877.536.3976 (US Toll-free)  
Office: +1.408.962.0515 (US/International)

Sales and Customer Service Hours  
Monday - Friday: 6:00 a.m. - 4:30 p.m. (PST)

<http://www.atlona.com/>

### International Headquarters

Atlona International AG  
Ringstrasse 15a  
8600 Dübendorf  
Switzerland

Office: +41 43 508 4321

Sales and Customer Service Hours  
Monday - Friday: 09:00 - 17:00 (UTC +1)

## Operating Notes

---

As of this writing, there are no firmware updates for this product. When new firmware is released, update instructions will be included with the firmware and will be appended to this manual.



**IMPORTANT:** Visit <http://www.atlona.com/product/AT-HDR-H2H-44MA> for the latest firmware updates and User Manual.

# Atlona, Inc. (“Atlona”) Limited Product Warranty

---

## Coverage

Atlona warrants its products will substantially perform to their published specifications and will be free from defects in materials and workmanship under normal use, conditions and service.

Under its Limited Product Warranty, Atlona, at its sole discretion, will either:

- repair or facilitate the repair of defective products within a reasonable period of time, restore products to their proper operating condition and return defective products free of any charge for necessary parts, labor and shipping.

OR

- replace and return, free of charge, any defective products with direct replacement or with similar products deemed by Atlona to perform substantially the same function as the original products.

OR

- refund the pro-rated value based on the remaining term of the warranty period, not to exceed MSRP, in cases where products are beyond repair and/or no direct or substantially similar replacement products exist.

Repair, replacement or refund of Atlona products is the purchaser’s exclusive remedy and Atlona liability does not extend to any other damages, incidental, consequential or otherwise.

This Limited Product Warranty extends to the original end-user purchaser of Atlona products and is non-transferrable to any subsequent purchaser(s) or owner(s) of these products.

## Coverage Periods

Atlona Limited Product Warranty Period begins on the date of purchase by the end-purchaser. The date contained on the end-purchaser’s sales or delivery receipt is the proof purchase date.

### Limited Product Warranty Terms – New Products

- 10 years from proof of purchase date for hardware/electronics products purchased on or after June 1, 2013.
- 3 years from proof of purchase date for hardware/electronics products purchased before June 1, 2013.
- Lifetime Limited Product Warranty for all cable products.

### Limited Product Warranty Terms – Refurbished (B-Stock) Products

- 3 years from proof of purchase date for all Refurbished (B-Stock) hardware and electronic products purchased on or after June 1, 2013.

## Remedy

Atlona recommends that end-purchasers contact their authorized Atlona dealer or reseller from whom they purchased their products. Atlona can also be contacted directly. Visit [www.atlona.com](http://www.atlona.com) for Atlona’s contact information and hours of operation. Atlona requires that a dated sales or delivery receipt from an authorized dealer, reseller or end-purchaser is provided before Atlona extends its warranty services. Additionally, a return merchandise authorization (RMA) and/or case number, is required to be obtained from Atlona in advance of returns.

Atlona requires that products returned are properly packed, preferably in the original carton, for shipping. Cartons not bearing a return authorization or case number will be refused. Atlona, at its sole discretion, reserves the right to reject any products received without advanced authorization. Authorizations can be requested by calling 1-877-536-3976 (US toll free) or 1-408- 962-0515 (US/international) or via Atlona’s website at [www.atlona.com](http://www.atlona.com).

## Exclusions

This Limited Product Warranty excludes:

- Damage, deterioration or malfunction caused by any alteration, modification, improper use, neglect, improper packaging or shipping (such claims must be presented to the carrier), lightning, power surges, or other acts of nature.

## Atlona, Inc. (“Atlona”) Limited Product Warranty

---

- Damage, deterioration or malfunction resulting from the installation or removal of this product from any installation, any unauthorized tampering with this product, any repairs attempted by anyone unauthorized by Atlona to make such repairs, or any other cause which does not relate directly to a defect in materials and/or workmanship of this product.
- Equipment enclosures, cables, power supplies, batteries, LCD displays, and any accessories used in conjunction with the product(s).
- Products purchased from unauthorized distributors, dealers, resellers, auction websites and similar unauthorized channels of distribution.

### **Disclaimers**

This Limited Product Warranty does not imply that the electronic components contained within Atlona’s products will not become obsolete nor does it imply Atlona products or their electronic components will remain compatible with any other current product, technology or any future products or technologies in which Atlona’s products may be used in conjunction with. Atlona, at its sole discretion, reserves the right not to extend its warranty offering in instances arising outside its normal course of business including, but not limited to, damage inflicted to its products from acts of god.

### **Limitation on Liability**

The maximum liability of Atlona under this limited product warranty shall not exceed the original Atlona MSRP for its products. To the maximum extent permitted by law, Atlona is not responsible for the direct, special, incidental or consequential damages resulting from any breach of warranty or condition, or under any other legal theory. Some countries, districts or states do not allow the exclusion or limitation of relief, special, incidental, consequential or indirect damages, or the limitation of liability to specified amounts, so the above limitations or exclusions may not apply to you.

### **Exclusive Remedy**

To the maximum extent permitted by law, this limited product warranty and the remedies set forth above are exclusive and in lieu of all other warranties, remedies and conditions, whether oral or written, express or implied. To the maximum extent permitted by law, Atlona specifically disclaims all implied warranties, including, without limitation, warranties of merchantability and fitness for a particular purpose. If Atlona cannot lawfully disclaim or exclude implied warranties under applicable law, then all implied warranties covering its products including warranties of merchantability and fitness for a particular purpose, shall provide to its products under applicable law. If any product to which this limited warranty applies is a “Consumer Product” under the Magnuson-Moss Warranty Act (15 U.S.C.A. §2301, ET SEQ.) or other applicable law, the foregoing disclaimer of implied warranties shall not apply, and all implied warranties on its products, including warranties of merchantability and fitness for the particular purpose, shall apply as provided under applicable law.

### **Other Conditions**

Atlona’s Limited Product Warranty offering gives legal rights, and other rights may apply and vary from country to country or state to state. This limited warranty is void if (i) the label bearing the serial number of products have been removed or defaced, (ii) products are not purchased from an authorized Atlona dealer or reseller. A comprehensive list of Atlona’s authorized distributors, dealers and resellers can be found at [www.atlona.com](http://www.atlona.com).

## Important Safety Information

**CAUTION**  
RISK OF ELECTRIC SHOCK  
DO NOT OPEN

CAUTION: TO REDUCT THE RISK OF  
ELECTRIC SHOCK  
DO NOT OPEN ENCLOSURE OR EXPOSE  
TO RAIN OR MOISTURE.  
NO USER-SERVICEABLE PARTS  
INSIDE REFER SERVICING TO  
QUALIFIED SERVICE PERSONNEL.



The exclamation point within an equilateral triangle is intended to alert the user to the presence of important operating and maintenance instructions in the literature accompanying the product.



The information bubble is intended to alert the user to helpful or optional operational instructions in the literature accompanying the product.

1. Read these instructions.
2. Keep these instructions.
3. Heed all warnings.
4. Follow all instructions.
5. Do not use this product near water.
6. Clean only with a dry cloth.
7. Do not block any ventilation openings. Install in accordance with the manufacturer's instructions.
8. Do not install or place this product near any heat sources such as radiators, heat registers, stoves, or other apparatus (including amplifiers) that produce heat.
9. Do not defeat the safety purpose of a polarized or grounding-type plug. A polarized plug has two blades with one wider than the other. A grounding type plug has two blades and a third grounding prong. The wide blade or the third prong are provided for your safety. If the provided plug does not fit into your outlet, consult an electrician for replacement of the obsolete outlet.
10. Protect the power cord from being walked on or pinched particularly at plugs, convenience receptacles, and the point where they exit from the product.
11. Only use attachments/accessories specified by Atlona.
12. To reduce the risk of electric shock and/or damage to this product, never handle or touch this unit or power cord if your hands are wet or damp. Do not expose this product to rain or moisture.
13. Unplug this product during lightning storms or when unused for long periods of time.
14. Refer all servicing to qualified service personnel. Servicing is required when the product has been damaged in any way, such as power-supply cord or plug is damaged, liquid has been spilled or objects have fallen into the product, the product has been exposed to rain or moisture, does not operate normally, or has been dropped.



## FCC Statement

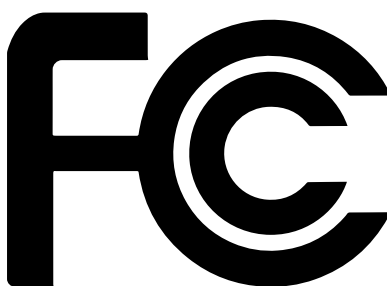

FCC Compliance and Advisory Statement: This hardware device complies with Part 15 of the FCC rules. Operation is subject to the following two conditions: 1) this device may not cause harmful interference, and 2) this device must accept any interference received including interference that may cause undesired operation. This equipment has been tested and found to comply with the limits for a Class A digital device, pursuant to Part 15 of the FCC Rules. These limits are designed to provide reasonable protection against harmful interference in a commercial installation.

This equipment generates, uses, and can radiate radio frequency energy and, if not installed or used in accordance with the instructions, may cause harmful interference to radio communications. However there is no guarantee that interference will not occur in a particular installation. If this equipment does cause harmful interference to radio or television reception, which can be determined by turning the equipment off and on, the user is encouraged to try to correct the interference by one or more of the following measures: 1) reorient or relocate the receiving antenna; 2) increase the separation between the equipment and the receiver; 3) connect the equipment to an outlet on a circuit different from that to which the receiver is connected; 4) consult the dealer or an experienced radio/TV technician for help. Any changes or modifications not expressly approved by the party responsible for compliance could void the user's authority to operate the equipment. Where shielded interface cables have been provided with the product or specified additional components or accessories elsewhere defined to be used with the installation of the product, they must be used in order to ensure compliance with FCC regulations.

# Table of Contents

---

<b>Introduction</b>	<b>8</b>
<b>Features</b>	<b>8</b>
<b>Package Contents</b>	<b>8</b>
<b>Panel Description</b>	<b>9</b>
<b>Installation</b>	<b>10</b>
Control	10
Audio	10
Mounting Instructions	11
Connection Instructions	13
Connection Diagram	13
<b>WebGUI</b>	<b>14</b>
<b>IR Remote Control</b>	<b>19</b>
<b>USB Updating</b>	<b>20</b>
<b>Appendix</b>	<b>21</b>
Specifications	21

## Introduction

---

The Atlona AT-HDR-H2H-44MA is an 4x4 HDMI matrix switcher for high dynamic range (HDR) formats. It is HDCP 2.2 compliant and supports 4K/UHD video @ 60 Hz with 4:4:4 chroma sampling, as well as HDMI data rates up to 18 Gbps. The AT-HDR-H2H-44MA is ideal for professional HDMI signal routing in residential and commercial applications where a number of AV sources must be shared throughout four zones to reduce the installed equipment footprint and to reduce the costs associated with multiple, redundant devices. It is compatible with all video resolutions, audio formats, and color space formats supported in the HDMI 2.0b specification, plus the ability to pass metadata for HDR content. The HDR-H2H-44MA includes EDID and HDCP management features, and can send CEC display control independently to each output. An unbalanced analog audio output is paired with each HDMI input for sending de-embedded HDMI audio to a whole-house audio system. The HDR-H2H-44MA can be controlled via Ethernet, RS-232, and IR. A handheld IR remote control is included.

## Features

---

- Supports resolutions up to 4K/UHD 60Hz @ chroma sub-sampling 4:2:0 10-bit
- HDCP 2.2 compliant
- EDID learning for up to 4 display EDIDs
- Built in internal EDID mode provides 14 unique EDIDs to ensure compatibility
- Multiple control options such as RS-232, IR, TCP/IP, webGUI, and front panel
- Multi-channel audio pass through up to Dolby Digital Plus, Dolby TrueHD, DTS-HD Master Audio, and Dolby Atmos

## Package Contents

---

- 1 x AT-HDR-H2H-44MA
- 1 x Captive screw connector, 5-pin
- 4 x Captive screw connector, 4-pin
- 1 x 24V DC power supply
- 1 x Pair mounting ears w/screws
- 4 x Feet w/screws
- 1 x IR remote control
- 1 x Installation Guide



# Panel Description

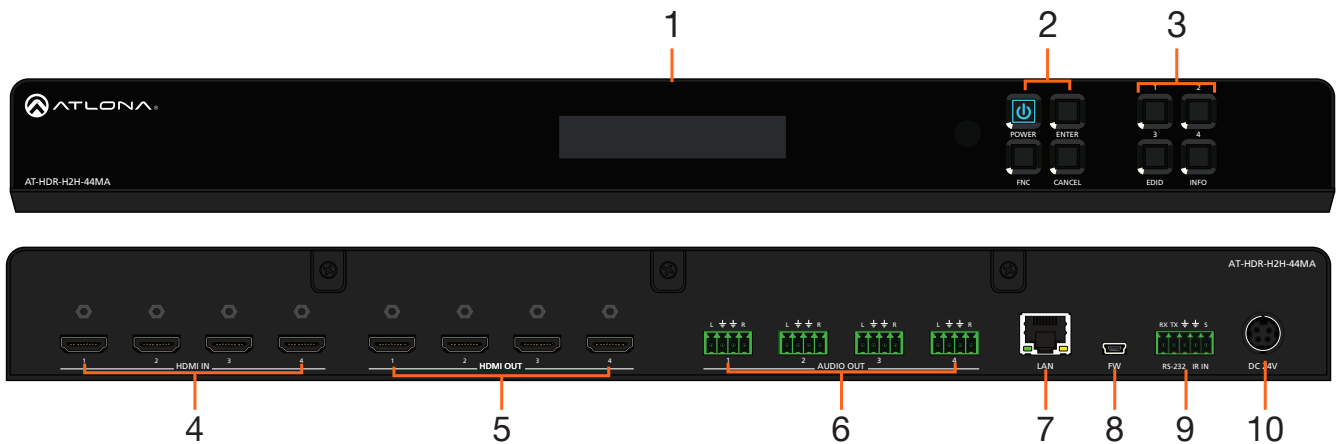

## OSD

Front panel OSD will display the on screen menu for routing, EDID management, and device info.

**i NOTE:** Starting on firmware 1.0.11, the front panel LCD will turn off after 30 seconds of inactivity. Press any button to activate the LCD again.

### 1 Function Buttons

**Power** - Sets the unit in and out of standby.  
**Enter** - Used for making selection within the front panel OSD.  
**FNC** - Use to switch number buttons to their secondary function.  
**CANCEL** - Navigates back one step in the front panel OSD.

### 2 Number Buttons

Use for selection of inputs and outputs.  
**1** - Press FNC + 1 to route selected input to all outputs.  
**2** - Press FNC + 2 to turn the IR receiver window on and off.  
**3** - Press FNC + 3 to open the EDID menu.  
**4** - Press FNC + 4 to display the device firmware. Press 4 again to view IP, IP port, and MAC.

### 3 HDMI IN

Connect HDMI cables to these ports from HDMI sources.

### 4 HDMI OUT

Connect an HDMI cable from this port to an HDMI display, extender, or switcher.

### 5 AUDIO OUT

This port provides source audio 2CH de-embedding. The audio of the HDMI inputs will be directly de-embedded to an audio DSP, amplifier, or player device.

### 6 LAN

Connect an Ethernet cable from this port to a Local Area Network (LAN). This port provides access to the webGUI or TCP/IP control.

### 7 FW

Connect a mini USB cable to this port to update the firmware.

### 8 Control Port

Connect a third party controller or PC to control the matrix through either IR or RS-232.

### 9 DC 24V

Connect the included 24V DC power supply to this power receptacle.

# Installation

## Control

A 5-pin captive screw connector for control has been included. The first three terminals are RS-232 control, the last two terminals are for IR.

1. Use wire strippers to remove a portion of the cable jacket.
2. Remove at least 3/16" (5 mm) from the insulation of each wire.
3. Insert the wires into the correct terminal on the included captive screw connector, as shown below.
4. Tighten the screws to secure the wires. Do not use high-torque devices as this may damage the screws and/or connector.

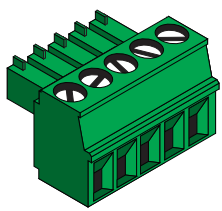

### RS-232

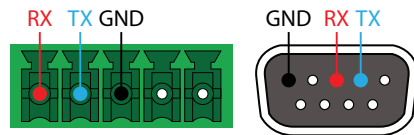

Pin out will be determined by the RS-232 cable and connect as RX (receive), TX (transmit) and  $\perp$  (Ground).

### IR

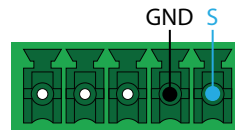

IR IN is connected by a ground and signal wire. Use with 3rd party control systems. For easy termination, Atlona recommends using the 2 meter IR cable AT-LC-CS-IR-2M.

## Audio

Connect to an audio DSP, amplifier, or other audio distribution or player devices. Only unbalanced connections may be used.

**NOTE:** Audio is directly de-embedded from the HDMI IN ports and are **not** zone output audio ports.

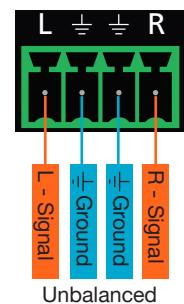
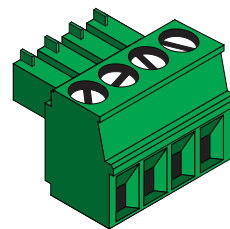

## Mounting Instructions

The AT-HDR-H2H-44MA can be placed freestanding on top of a desk, a table, or in a cabinet. To prevent damage to the surfaces or unnecessary movement of the matrix, four feet have been included.

### Rack installation

1. Remove the front two case screws from the sides of the case.
2. Attach the included rack ears to each side of the AT-HDR-H2H-44MA using the case screws.
3. Install the HDR-H2H into a rack, using four rack screws.

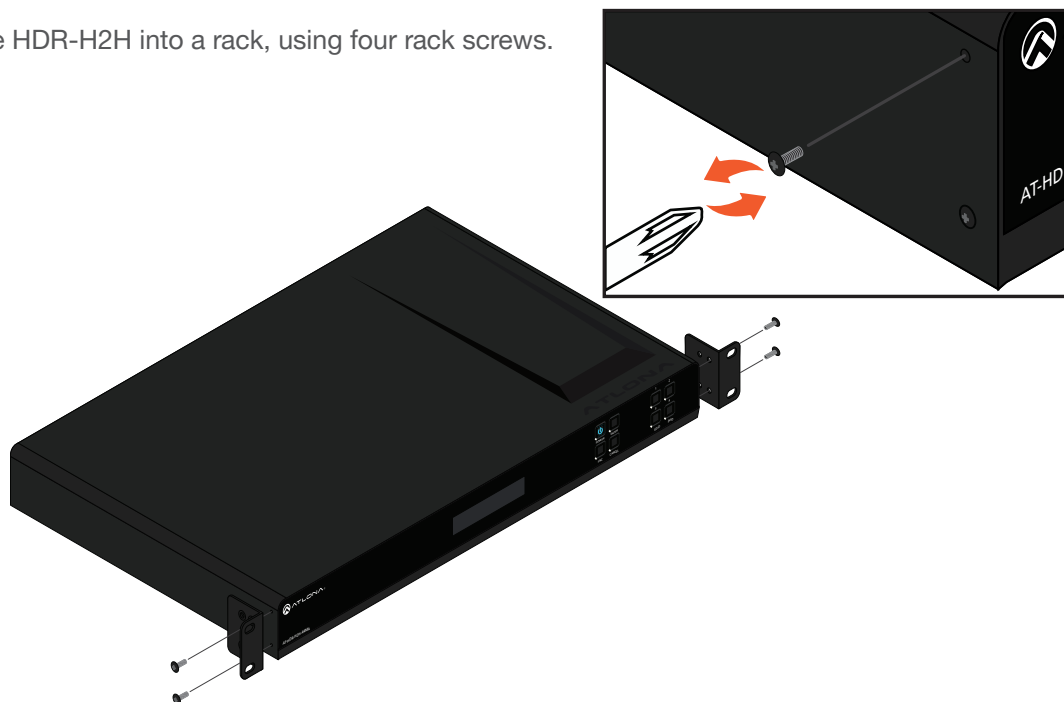

**i NOTE:** Increase the air flow as needed to maintain the recommended temperature inside the rack.

**i NOTE:** Do not exceed the maximum weight loads for the rack. Install heavier equipment in the lower part of the rack for stability.

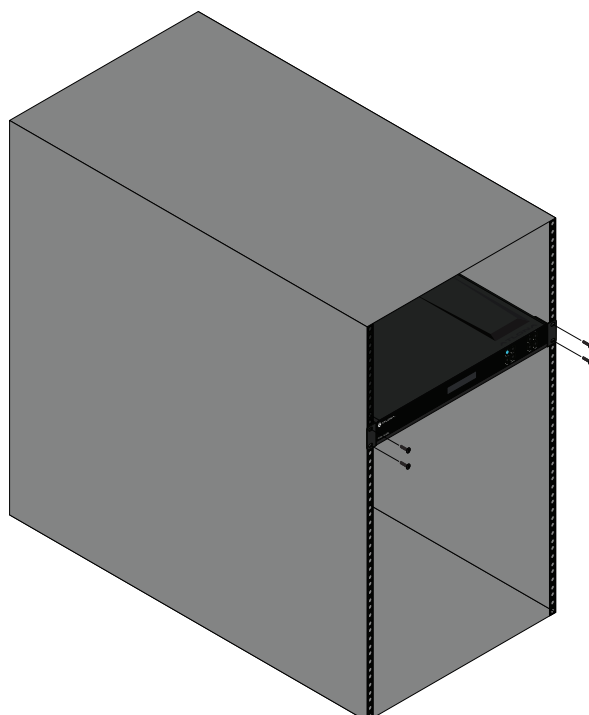

### Surface mounting

The AT-HDR-H2H-44MA can be placed freestanding on top of a desk, a table, or in a cabinet. To prevent damage to the surfaces or unnecessary movement of the matrix, four feet have been included.

1. Turn the unit upside down.
2. Install each foot using the included feet screws, the rubber grips of the feet should be facing up during installation.
3. Turn the unit right-side up and place it in the desired location.

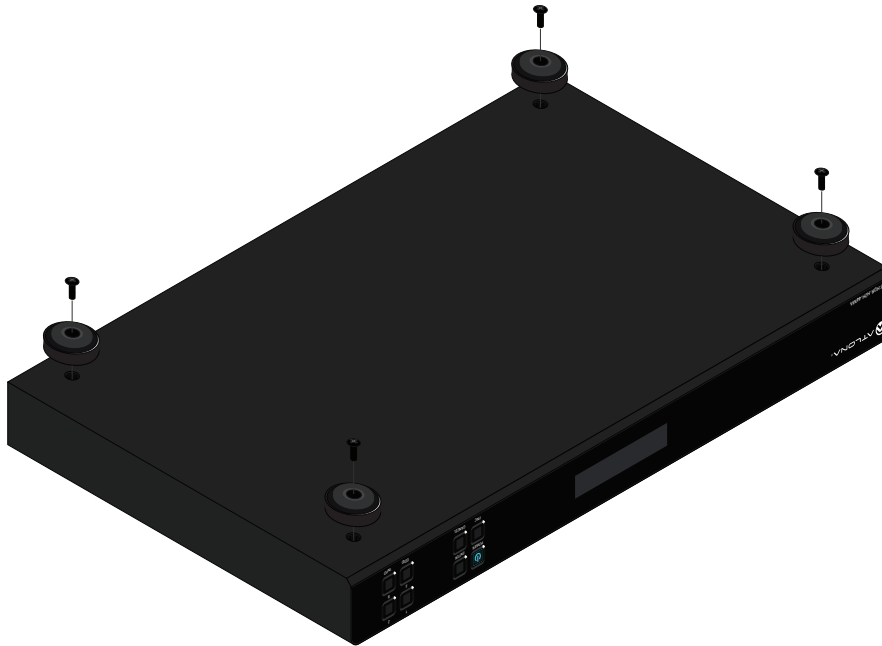

## Connection Instructions

1. Connect up to 4 HDMI sources to the HDMI IN ports.
2. Connect up to 4 HDMI displays to the HDMI OUT ports.
3. For control, connect to the captive screw port for IR and RS-232, or the LAN port for TCP/IP and webGUI.
4. Connect the included 24V power supply to the DC 24V port.
5. Connect the power supply to an AC outlet.

## Connection Diagram

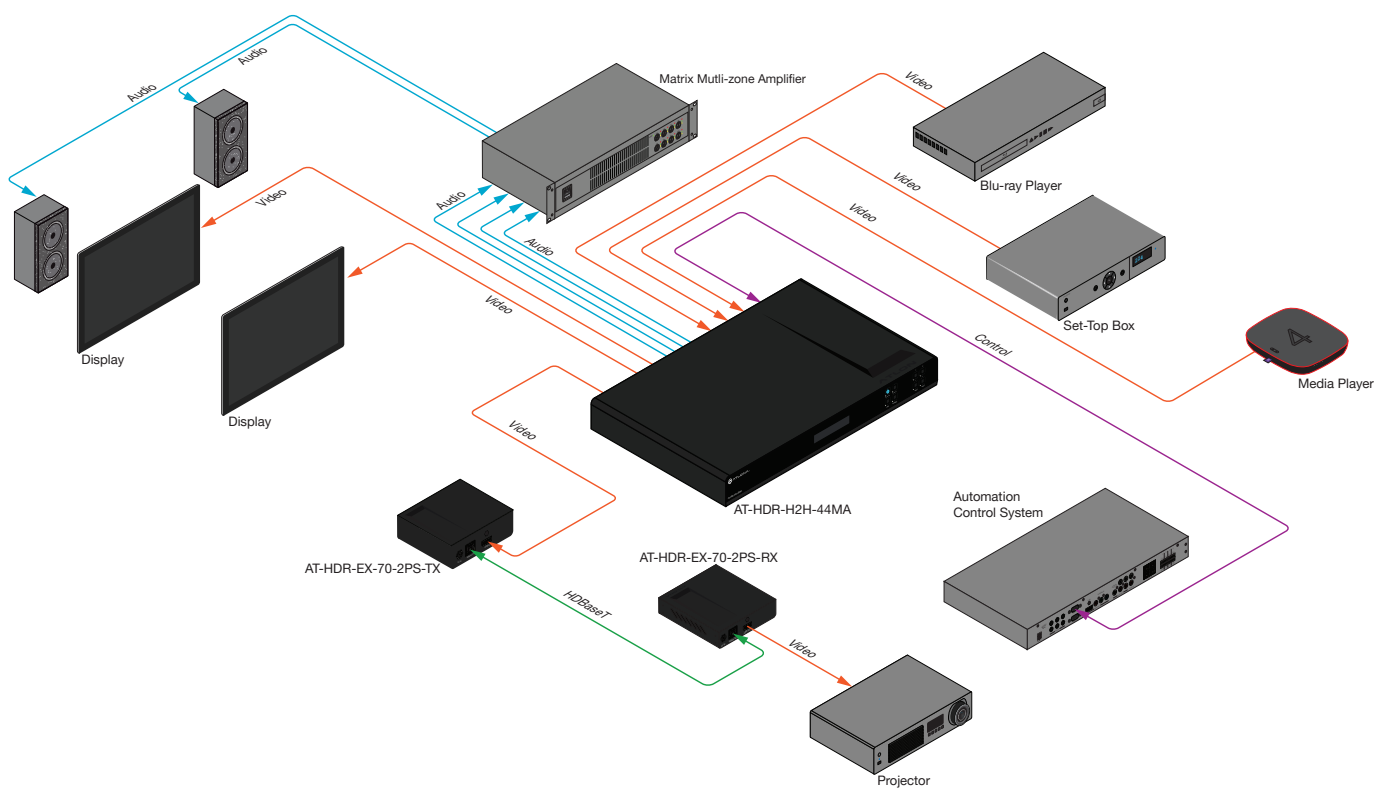

## WebGUI

The AT-HDR-H2H-44MA includes a built-in webGUI, which allows easy management and control of all features. Follow the instructions below to access the webGUI.

1. View the IP address of the unit using the front panel OSD.
  - Press the FNC button.
  - Press button 4 (INFO). The firmware version will display on the front panel screen.
  - Press button 4 again to bring up the IP address.

**i NOTE:** If there is no IP address or the unit is not connected to a DHCP network, press and hold buttons 1 + 2 for 5 seconds to switch the unit to a static IP address. The default static IP address and netmask is 192.168.1.254 255.255.0.0.

2. Launch a web browser and enter the IP address of the unit.
3. The AT-HDR-H2H-44MA **Login** page will be displayed.
4. Enter the following information on the **Login** page.

Login: **root**  
 Password: **Atlona**

5. Click the **Login** button.



6. The info page will display, giving all the general information of the AT-HDR-H2H-44MA .

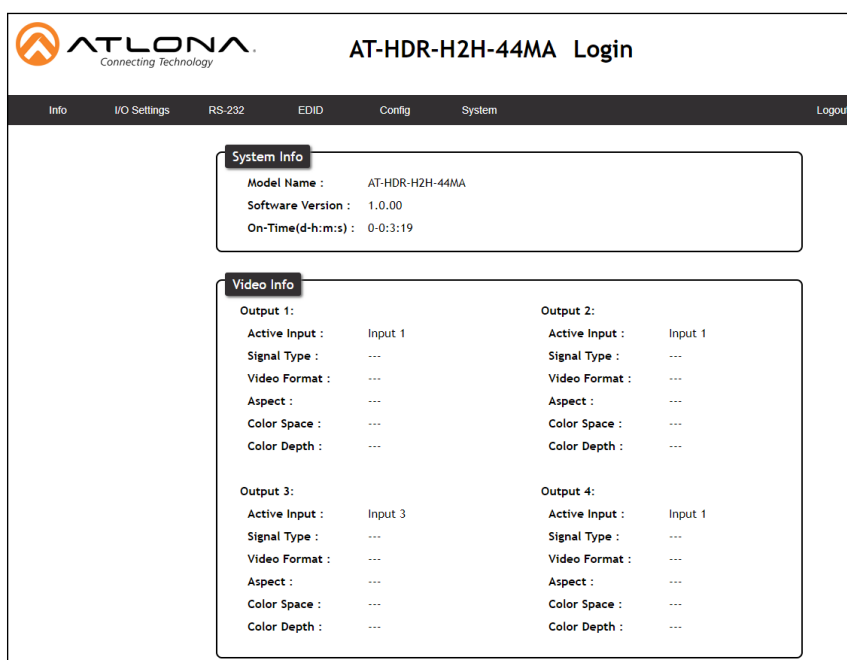

**System Info**

Model Name : AT-HDR-H2H-44MA  
 Software Version : 1.0.00  
 On-Time(d-h:m:s) : 0-0:3:19

**Video Info**

<b>Output 1:</b>		<b>Output 2:</b>	
Active Input :	Input 1	Active Input :	Input 1
Signal Type :	---	Signal Type :	---
Video Format :	---	Video Format :	---
Aspect :	---	Aspect :	---
Color Space :	---	Color Space :	---
Color Depth :	---	Color Depth :	---
<b>Output 3:</b>		<b>Output 4:</b>	
Active Input :	Input 3	Active Input :	Input 1
Signal Type :	---	Signal Type :	---
Video Format :	---	Video Format :	---
Aspect :	---	Aspect :	---
Color Space :	---	Color Space :	---
Color Depth :	---	Color Depth :	---

7 Select **I/O Settings** from the top menu.

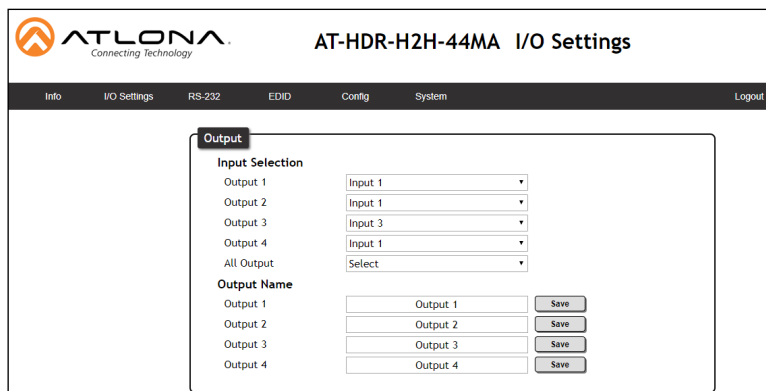

### Output

Input Selection - Select the input to route to the output.

Output Name - The outputs have the option for labeling to help make routing and switching simpler. Label each output individually. Type the name in the box, and press save.

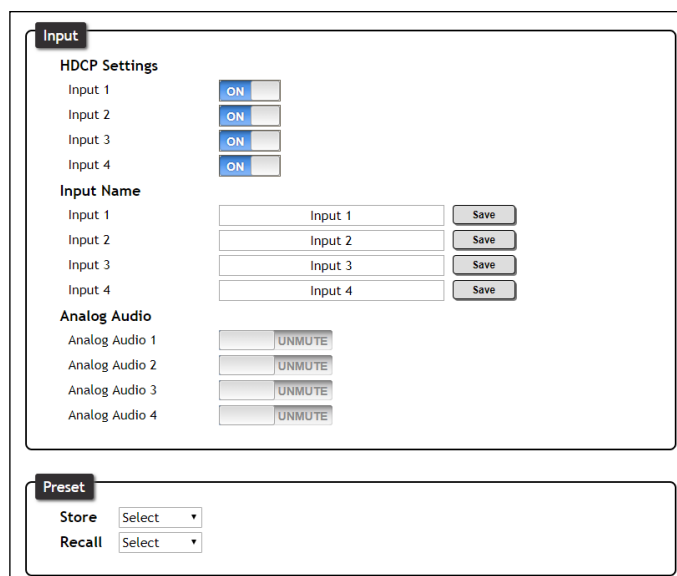

### Input

HDCP Settings - Toggle HDCP reporting between compliant (on) and non-compliant (off).

Input Name - The inputs have the option for labeling to help make routing and switching simpler. Label each input individually. Type the name in the box, and press save.

Analog Audio - Mute and unmute the output audio on the selected Analog Audio port.

### Preset

Store - Save the current I/O route to memory.

Recall - Load a previously saved I/O route.

8 Select **RS-232** from the top menu.

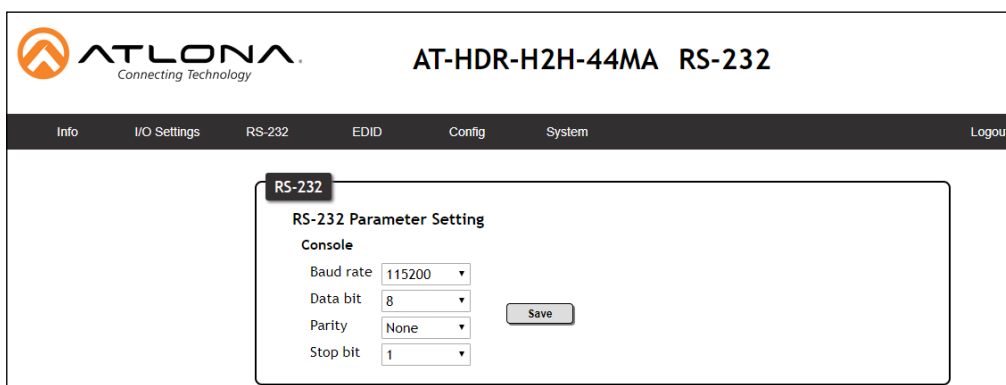

### RS-232 Parameter Setting

Console - Select the baud rate, data bit, parity, and stop bit. Default baud rate, data bit, parity, and stop bit is 1152000, 8, None, and 1.

9 Select **EDID** from the top menu.

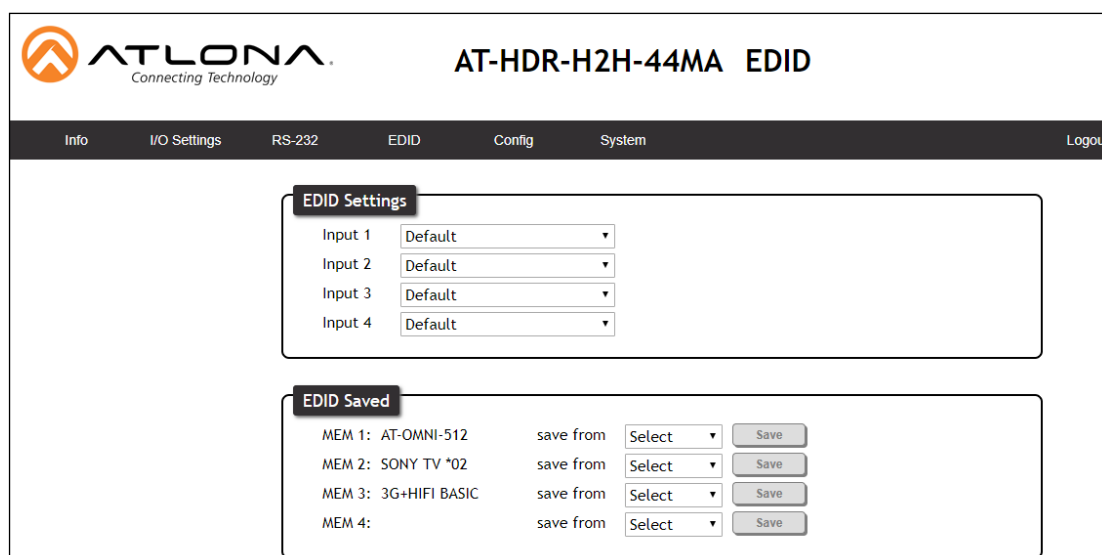

### EDID Settings

Input - Select the EDID from the drop down list.

### EDID Saved

Save from - Save the output's EDID to memory to be loaded to the inputs.



10 Select **Config** from the top menu.

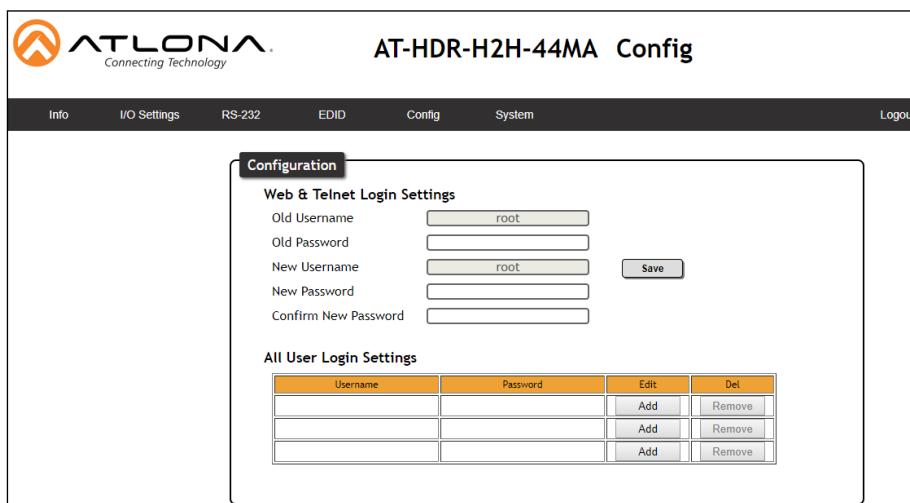

Username	Password	Edit	Del
		Add	Remove
		Add	Remove
		Add	Remove

### Web & Telnet Login Settings

Password - Update the admin password then press **Save**.

### All User Login Settings

Username & Password - Add extra users for control and login.

11 Select **System** from the top menu.

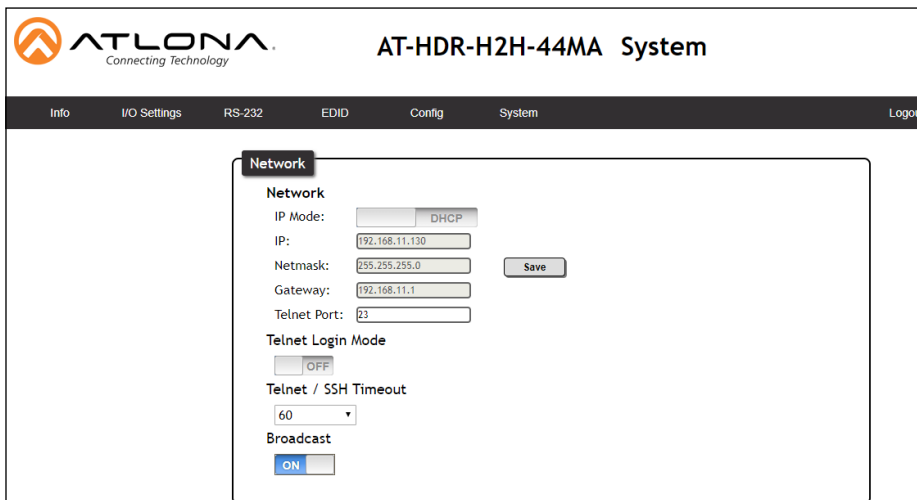

### Network

IP Mode - Switch between static and DHCP modes.

IP, Netmask, Gateway, Telnet Port - This will display the current IP settings on DHCP. When set to static, fill in the IP address, netmask, gateway, and telnet port.

Telnet Login Mode - Toggle telnet login mode on and off. If on, a username and password will be required to control the unit via TCP/IP.

Telnet / SSH Timeout - Set the amount of time between actions before the current user is logged out.

Broadcast - Toggles broadcast on and off.

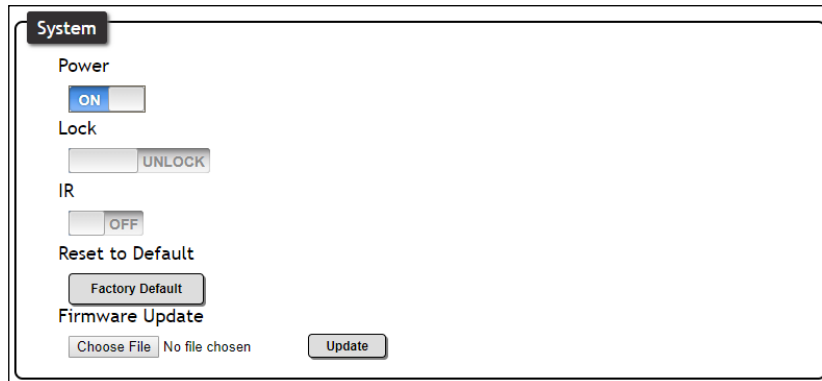

### System

Power - Toggles the unit between on and standby.

Lock - Lock and unlock the front panel keys.

IR - Turns the IR window on the front of the unit on and off.

Reset to Default - Select to set the unit back to the original factory settings.

Firmware Update - Press **Choose File** to search the local PC for the most recent firmware file. Press **Update** once the file is selected.

## IR Remote Control

The AT-HDR-H2H-44MA comes with an IR Remote Control for easy routing.

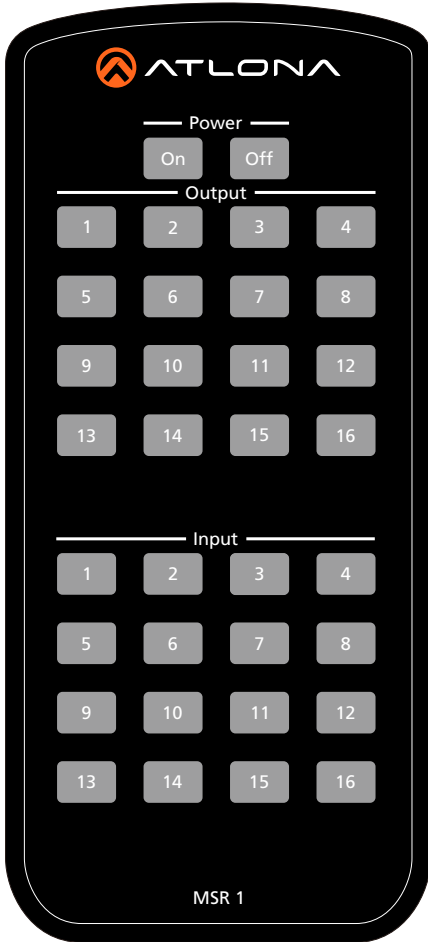

Power On - Turn the unit on.

Power Off - Set the unit into standby mode.

Output - Select the number key for the corresponding output port for routing.

Input - Select the number key for the corresponding input port for routing.

**NOTE:** Only buttons 1 through 4 are used in the Input and Output selections.

To route the HDMI inputs and outputs:

1. Make sure the unit is powered on, if not, select the Power On button.
2. Press the Input # button of the device to route.
3. Press the Output # button for the device the input will be routed to.

The selected input will route to the output.

# USB Updating

The HDR-H2H can be updated through the FW port on the back of the unit, if the webGUI is not available for updating.

Requirements:

- New firmware - Downloaded from [atlona.com](http://atlona.com)
- AT-HDR-H2H-XX
- Computer running Windows
- USB-A to USB mini-B cable

1. Connect power to the HDR-H2H.
2. Press and hold the **CANCEL** button on the front panel, while connecting the USB-A to USB mini-B cable from the computer, to the **FW** port on the rear of the unit. Continue to hold down the **CANCEL** button until Step 3.

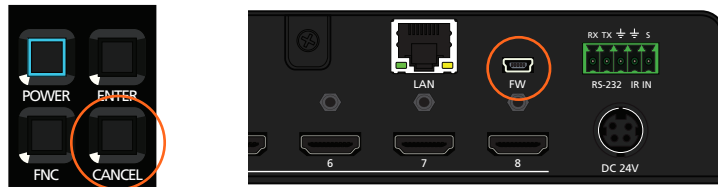

3. Release the **CANCEL** button once the USB UPDATE folder is displayed.

If the folder is not displayed, automatically, select the USB UPDATE drive from Windows Explorer.

4. Delete any files found within the USB UPDATE drive folder.
5. Drag and drop the new firmware file into the folder. The power LED will flash red while the unit is updating.
6. Once the unit has automatically rebooted and the power button's LED is back to blue, disconnected the USB cable from the unit and computer. The update is now complete.

# Appendix

## Specifications

Video	
UHD/HD/SD	4096x2160@24/25/30/50/60Hz, 3840x2160@24/25/30/50/60Hz, 2048x1080p, 1080p@23.98/24/25/29.97/30/50/59.94/60Hz, 1080i@50/59.94/60Hz, 720p@50/59.94/60Hz, 576p, 576i, 480p, 480i
VESA	2560x2048, 2560x1600, 2048x1536, 1920x1200, 1680x1050, 1600x1200, 1600x900, 1440x900, 1400x1050, 1366x768, 1360x768, 1280x1024, 1280x800, 1280x768, 1152x768, 1024x768, 800x600
Color Space	YUV, RGB
Chroma Sampling	4:4:4, 4:2:2, 4:2:0
Color Depth	8-bit, 10-bit, 12-bit
HDR	HDR10 and Dolby® Vision™ @ 60Hz

Audio	
HDMI IN / OUT	PCM 2Ch, LPCM 5.1, LPCM 7.1, Dolby® Digital, DTS® 5.1, Dolby Digital Plus™, Dolby TrueHD, DTS-HD Master Audio™, Dolby Atmos®, DTS:X®
Sample Rate	32kHz, 44.1kHz, 48kHz, 88.2kHz, 96kHz, 176.4kHz, 192kHz
Bit Rate	up to 24-bit

Distance	Feet	Meters
HDMI IN / OUT @ 4K	15	5
HDMI IN / OUT @ 1080p	30	10

Signal	
Bandwidth	18 Gbps
CEC	Yes
HDCP	2.2

Temperature	Fahrenheit	Celsius
Operating	32 to 122	0 to 50
Storage	-40 to 158	-40 to 70
Humidity (RH)	20% to 90%, non-condensing	

Power	
Consumption	34.3 W
Idle Consumption	11.1 W
Supply	Input: 110 - 240 VAC, 50 / 60 Hz Output: 24V DC, 2.7A

Dimensions	Inches	Millimeters
H x W x D	1.73 x 17.24 x 10.00	44.00 x 438.00 x 254.00
H x W x D, w/feet/ears	2.18 x 18.93 x 10.23	55.50 x 481.00 x 260.00
Rack Size	1 RU	

Weight		Pounds	Kilograms
Device		6.10	2.78
Certification			
Power Supply	CE, FCC, UL, and LVD certificates Level VI compliant		
Unit	CE, FCC		

