

# Contents

Display panel	2	Troubleshooting	16
Important safety instructions	3	Technical information	19
Before washing for the first time	4	Installation instructions	20
Loading the dishwasher	5	Service	22
Using the dishwasher	8	Notes	23
Settings	12	Quick start guide	24
Care and maintenance instructions	14		

Dear Customer,

Thank you for choosing this quality product from ASKO.

We hope it will meet your expectations and fulfill your needs for many years to come. Scandinavian design combines clean lines, everyday functionality, and high quality. These are key characteristics of all our products and the reason they are greatly appreciated throughout the world.

To get the most out of your new dishwasher, we recommend that you read the operating instructions before using it. The last page also includes a Quick start guide.

## Display panel

To switch on the dishwasher, press and hold the main power switch until the display lights up.

**"Welcome to your new ASKO. This is a first time set up."** is shown on the display the first time the dishwasher is switched on. It is important that you choose the right settings to ensure good dishwashing results. See page 4.

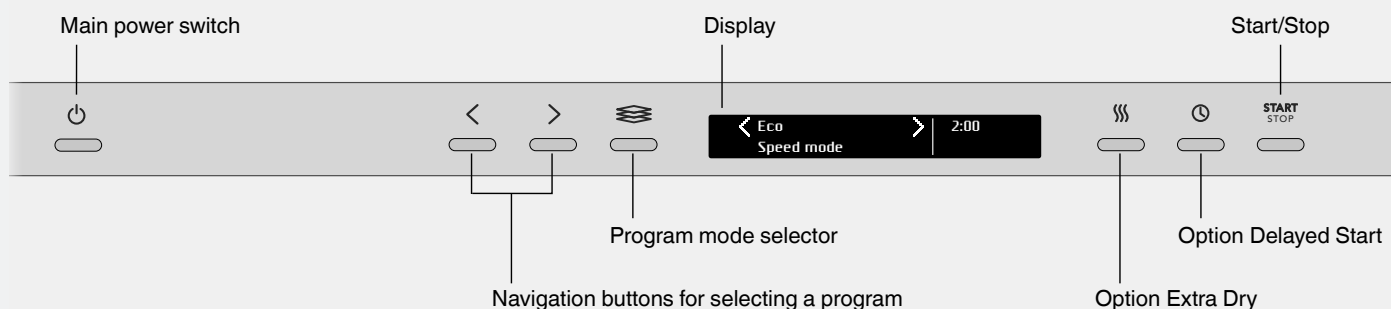

# Important safety instructions

## SAVE THESE INSTRUCTIONS FOR FUTURE REFERENCE

### WARNING!

When using your dishwasher, follow basic precautions, including the following:

- Read all instructions before using the dishwasher.
- Use the dishwasher only for its intended function.
- Use only detergents or wetting agents recommended for use in a dishwasher and keep them out of the reach of children.
- When loading items to be washed:
  - locate sharp items so that they are not likely to damage the door seal, and
  - load sharp knives with the handles up to reduce the risk of cut-type injuries.
- Do not wash plastic items unless they are marked “dishwasher safe” or the equivalent. For plastic items not so marked, check the manufacturer’s recommendations.
- Do not operate the dishwasher unless all enclosure panels are properly in place.
- Do not tamper with controls.
- Do not abuse, sit on, or stand on the door or dish rack of the dishwasher.
- To reduce the risk of injury, do not allow children to play in or on a dishwasher.
- Under certain conditions, hydrogen gas may be produced in a hot water system that has not been used for two weeks or more. HYDROGEN GAS IS EXPLOSIVE. If the hot water system has not been used for two weeks, before using the dishwasher turn on all hot water faucets and let the water flow from each for several minutes. This will release any accumulated hydrogen gas. As the gas is flammable, do not smoke or use an open flame during this time.
- Remove the door to the washing compartment when removing an old dishwasher from service or discarding it.
- Read the grounding instructions in the installation instructions.

## General

- Do not run the dishwasher while you are out of the home.
- Do not store or use combustible materials, gasoline, or other flammable vapors and liquids in the vicinity of this or any other appliance.
- Disconnect electrical power to dishwasher before servicing.
- Repairs should be done by a qualified technician.

### WARNING!

This product may contain chemicals known to the state of California to cause cancer or reproductive harm.

## Installation

See the chapter Installation instructions.

## Child safety

### TIP!

Dishwasher detergents and rinse aids are corrosive, so always keep them out of reach of children.

- Should a child swallow dishwasher detergent or rinse aid, give plenty to drink immediately, i.e., one or two glasses of milk or water. Do not try to induce vomiting. Seek medical advice immediately: Call the National Capital Poison Center at 1-800-222-1222.
- Always close the door and start the dishwasher as soon as you put in the detergent.
- Always keep small children away from the machine when it is open. There may be some detergent residue left inside the machine.
- If dishwasher detergent gets in someone’s eyes, rinse them with plenty of water for at least 15 minutes.

### Activate child lock (Kid Safe™)

You can activate the child lock (button lock) to prevent children from starting the dishwasher. See the chapter Settings.

## Winter storage/Transport

- Store the dishwasher where the temperature remains above freezing.
- Avoid long transport distances in very cold weather.
- Transport the dishwasher upright or laying on its back.

## Overflow guard function

The overflow protection starts pumping out the machine and turns off the water supply if the water level in the dishwasher exceeds the normal level. If the overflow protection is triggered, turn off the water supply and call the Customer Care Center.

## Packing material

The packaging protects the product during transport. The packaging material is recyclable. Separate the different packaging materials to help reduce raw material use and waste. Your dealer can take the packaging for recycling or direct you to the nearest recycling center. The packaging is comprised of:

- Corrugated cardboard made from up to 100% recycled material.
- Expanded polystyrene (EPS) with no added chlorine or fluorine.
- Supports made from untreated wood.
- Protective plastic made from polyethylene (PE).

## Disposal

- When the machine has reached the end of its service life and is to be disposed of, it should immediately be made unusable. Pull out the power cable and cut it as short as possible.
- The dishwasher is manufactured and labeled for recycling.
- Contact your municipality for information about where and how your dishwasher can be recycled correctly.

# Before washing for the first time

## 1. Checking water hardness

Contact the local water utility to check the water hardness in your area. This is important to determine how much detergent and rinse aid to use.

In general, more rinse aid and detergent are needed for hard water.

## 2. Basic settings

To switch on the dishwasher, press and hold the main power switch until the display lights up.

**"Welcome to your new ASKO. This is a first time set up."** is shown on the display. It is important that you choose the right settings to ensure good dishwashing results.

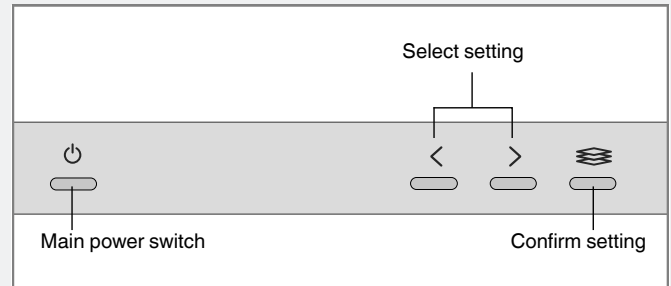

Settings	
1	<b>Language</b>
Select the language to be shown on the display.	
2	<b>Rinse aid</b> 0/1/2/3/4/5
Use rinse aid to improve wash and dry times. Also use rinse aid to achieve clear and spotless results. Select rinse aid dosage. The rinse aid dispenser can be adjusted between 0 (Off) and 5 (High dosage). <i>Pre-selected at factory: 5</i>	

To change the chosen setting, see the chapter *Settings*.

# Loading the dishwasher

## 3. Top up with rinse aid

Use rinse aid to improve wash and dry times. Also use rinse aid to achieve clear and spotless results.

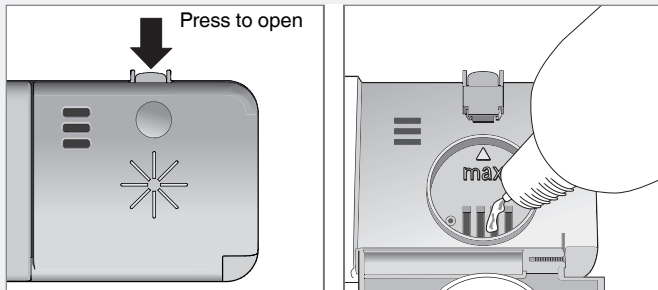

- 1 Open the rinse aid compartment lid.
- 2 Carefully top up with rinse aid. Only add rinse aid to the level marked **max**.
- 3 Wipe up any spilled rinse aid around the compartment.
- 4 Close the lid firmly.

### Add rinse aid

When the rinse aid needs topping up, the above symbol lights on the display.

After topping up, it may take a while before the symbol goes out.

#### NOTE!

##### **Increase the rinse aid dosage:**

- If the dishes have water marks.

##### **Reduce the rinse aid dosage:**

- If the dishes have a sticky white/blue film.
- If the dishes are streaked.
- Heavy foaming. If you have very soft water, the rinse aid can be diluted 50:50 with water.

## Energy-efficient dishwashing

### **Run programs only with a full load**

Wait until the dishwasher is fully loaded before running a program, this way you save energy. Use the Rinse and hold program to rinse the dishes if there are any unpleasant odors while you wait for the dishwasher to become fully loaded.

### **Run programs at a lower temperature**

If the dishes are only lightly soiled, you can select a program with a low temperature.

### **Select Green mode**

The dishwasher has different program modes. To save energy and water, use Green mode.

Better drying results are achieved if you open the door a little once the program has ended. (If the dishwasher is built-in, the surrounding furnishings must be resistant to any condensation from the dishwasher.)

### **Do not rinse under running water**

Simply scrape off large food particles before loading the dishwasher.

### **Choose a green detergent**

Read the environmental declaration on the packaging!

### **Connect to cold water**

Connect the dishwasher to the cold water supply if the building is heated using oil, electricity, or gas.

### **Connection to hot water supply**

Connect the dishwasher to the hot water supply (max. 160 °F (70 °C)) if the building is heated using an energy-efficient means such as district heating, solar power, or geothermal power. Choosing a hot water connection cuts dishwashing times and reduces the dishwasher's energy consumption.

#### NOTE!

Do not exceed the permitted water supply temperature. Certain materials used in some cookware cannot withstand strong heat.

## Fragile dishes

Some cookware is not dishwasher safe. This can be for several reasons. Some materials cannot withstand high temperatures, others can be damaged by dishwasher detergent.

Use caution with, for example, handmade items, fragile decoration, crystal/glassware, silver, copper, tin, aluminum, wood, and plastic. Look for the "Dishwasher safe" marking.

### Fragile decoration

Porcelain with decoration on top of the glazing (the items feel rough) should not be washed in a dishwasher.

### Crystal/Glass

Wash fragile items made of crystal/glass, such as crystal glass from Orrefors, using the gentle dishwashing program Crystal glass. Remember to use a small amount of detergent and to place items so that they do not touch each other during the wash.

Use rinse aid to improve wash and dry times. Also use rinse aid to achieve clear and spotless results.

*Hand-painted glassware, as well as antique and very fragile items, should not be washed in a dishwasher.*

### Silver

Silver and stainless steel items should not come into contact, as the silver can become discolored.

### Aluminum

Aluminum can lose its shine if washed in a dishwasher. However, good quality aluminum pans can be washed in a dishwasher, even if some of the shine will be lost.

### Cutlery with glued handles

Some types of glue are not dishwasher safe. In such cases, the handles may loosen.

## Points to consider

- All dirty surfaces should face in and down!
- Dishes should not be placed in or on each other.
- Angle dishes with hollows, such as cups, so that the rinse water will run off. This is also important for plastic items.
- Place the upper basket in its highest position when dishwashing very large plates.
- Make sure small items cannot fall through the dishwasher basket; place them in the cutlery basket.

### NOTE!

Check that the spray arms can rotate freely.

## The baskets

The dishwasher includes an upper, a lower, and a cutlery basket.

*The basket appearance may differ depending on the configuration.*

## Upper basket

Place glasses, cups, bowls, side plates, and saucers in the upper basket. Place all soiled surfaces down! Place wine glasses on the wine shelf. Place knives on the knife stand, if applicable.

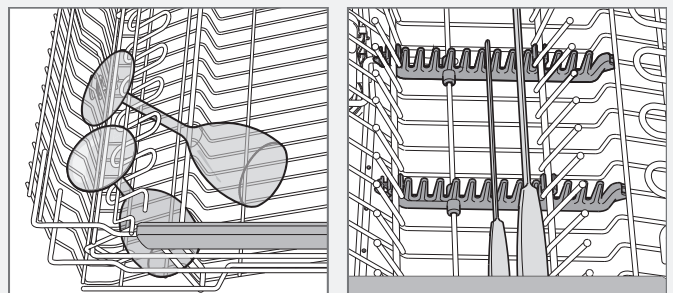
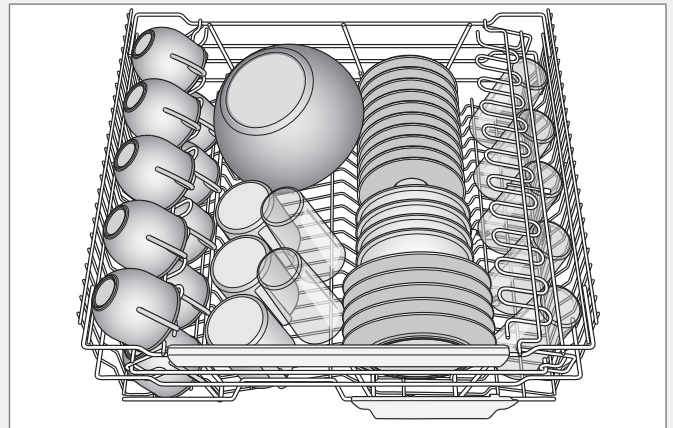

### Foldable tines

The foldable tines can be folded up or down to make it easier to load pots, bowls, and glasses. Release the foldable tines by pressing the catch inward before adjusting their position.

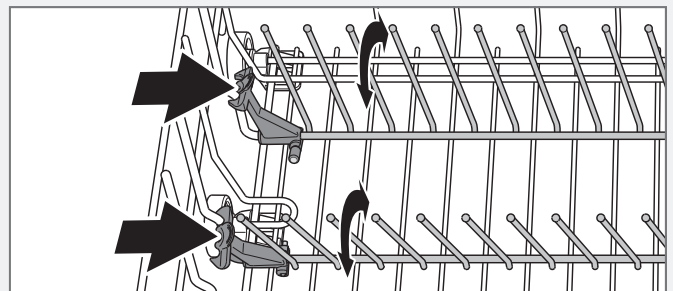

### Raising the upper basket

- 1 Pull out the upper basket.
- 2 Grab the sides of the upper basket with both hands and lift it up.

### Lowering the upper basket

- 1 Pull out the upper basket.
- 2 While holding the basket, pull out the two locking handles on either side to lower the upper basket.

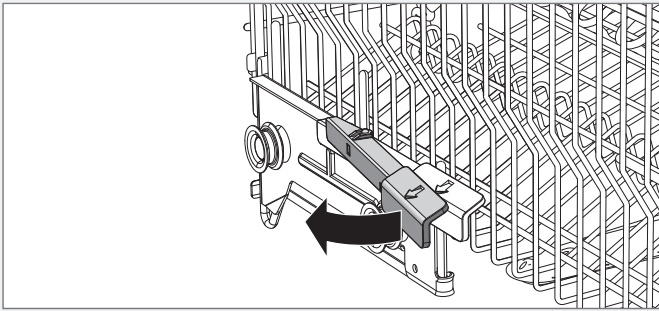

## Middle basket

The middle basket's wire basket with spray pipes is suitable for short objects. The middle basket's utensil basket has space for ladles, whisks, serving cutlery, and similar items.

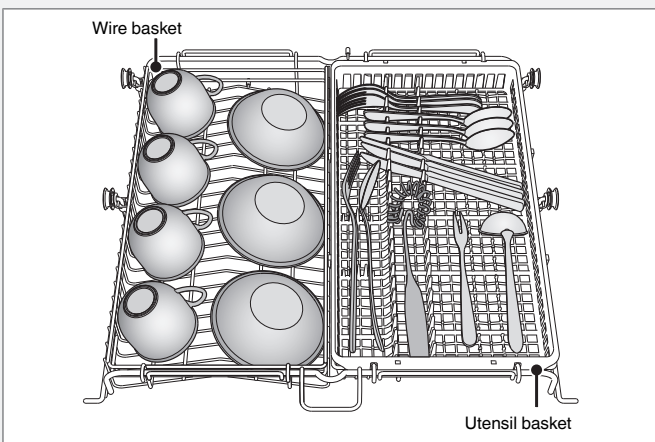

### Washing larger items

The two baskets in the middle basket can be removed, or the entire middle basket can be removed, to create more space between the upper and lower baskets if larger items are being washed.

## Lower basket

Place plates, side plates, serving dishes, pots, and cutlery (in the cutlery basket) in the lower basket.

Place pots and pans in the rear right of the lower basket for the best cleaning results from the two rear spray nozzles (WideSpray™), which are intended for these types of dishes.

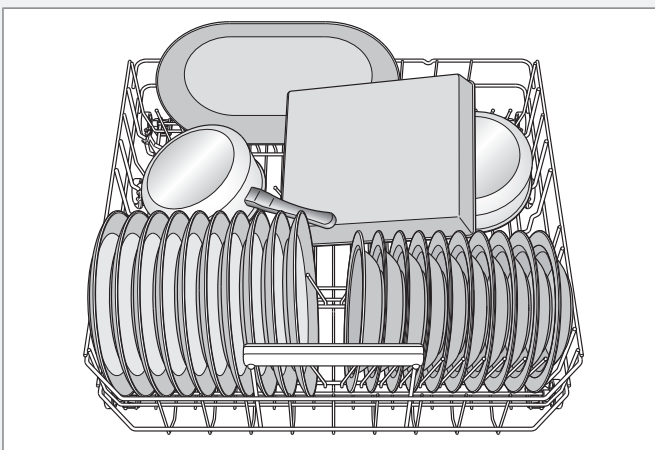

### Foldable tines

Lower the foldable tines when washing large pots. Release the foldable tines by pressing the catch inward before adjusting their position. In the rear right part of the lower basket, half of the foldable tines can be folded when washing, for example, stoneware or a large pan.

### Vase and bottle holder

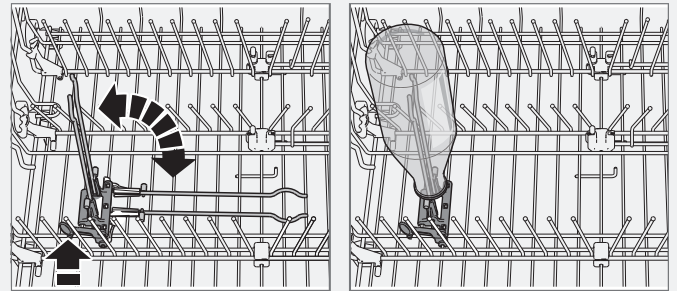

### Washing large plates

Move adjustable tines and their mounts to widen the distance between the tine rows to adapt the lower basket to plates with a diameter greater than 9 3/4" (25 cm).

## Cutlery basket

Place cutlery with the handles facing down, except for knives, and spread them out as much as possible. Ensure that spoons do not stack inside each other.

The cutlery basket is best placed in the middle at the front of the lower basket to best utilize dishwashing performance from the unique spray nozzle (Power Zone Cutlery™), which is intended for the cutlery basket.

### ⚠ WARNING!

Knives and other pointed items must be placed with the points down in the cutlery basket or horizontally in other baskets.

### Fold-down section for small items

The cutlery basket has a fold-down section in the middle for small items, or small shafts, such as electric whisk attachments.

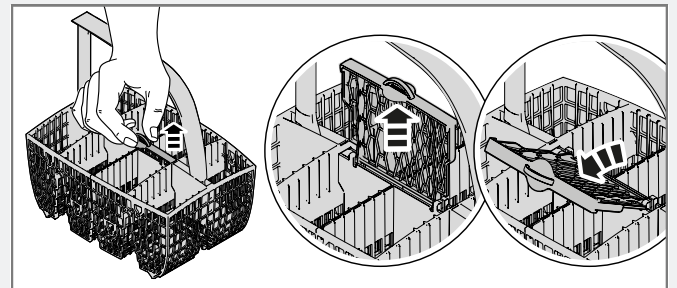

### Accessory

Buy an extra cutlery basket. The extra cutlery basket is flexible and can be dismantled and attached to the lower basket or the large cutlery basket to make an extra large cutlery basket. This accessory is available where you bought the dishwasher.

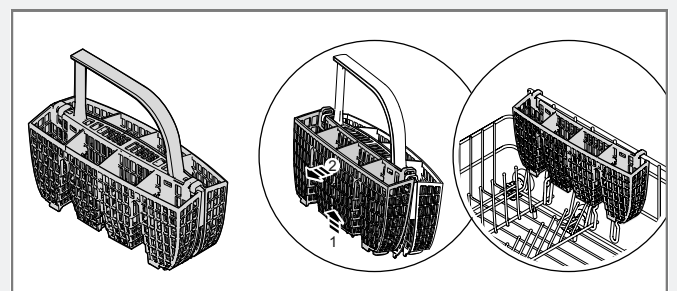

# Using the dishwasher

## Typical load

Recommended for daily, regular, or typical use.

### Upper basket

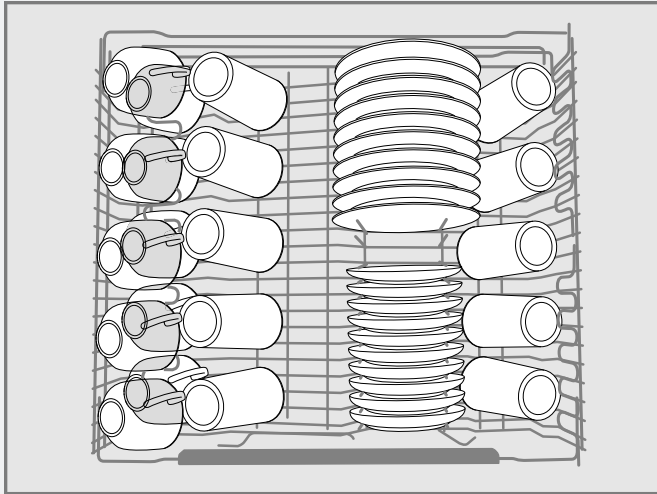

#### NOTE!

Ensure the upper basket is set to its lowest position.

### Lower basket

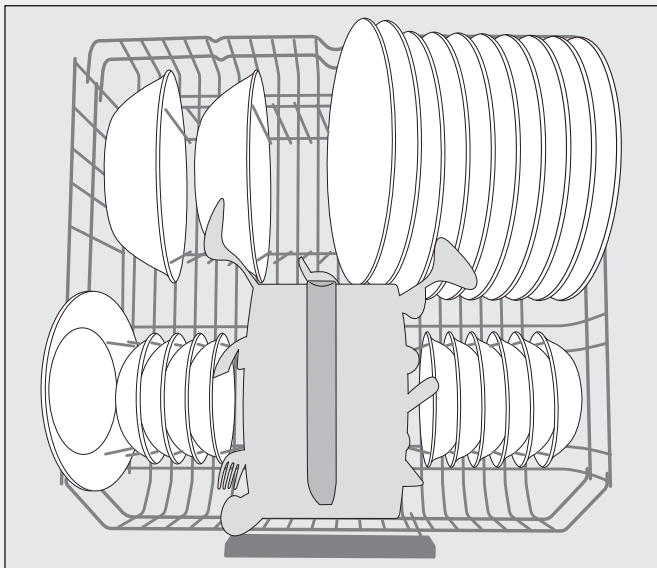

## Add detergent

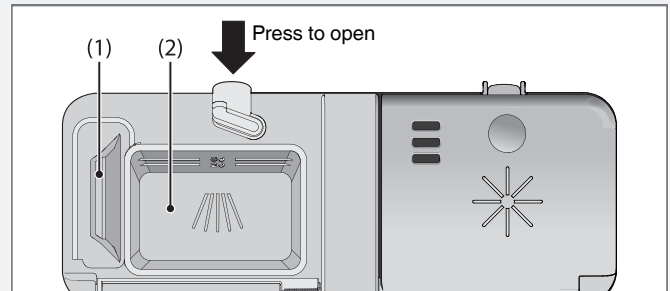

- 1 Prewash detergent compartment
- 2 Main wash detergent compartment

Detergent is added according to water hardness.

Follow the instructions on the detergent packaging.

Too much detergent can result in less effective dishwashing and also entails greater environmental impact.

The detergent compartment must be dry when adding detergent. There is one compartment for the prewash and one for the main wash. If powder or liquid dishwasher detergent is used, add a small amount of the detergent to the prewash compartment. Contact the detergent manufacturer if you have questions about the detergent.

#### NOTE!

Use only dishwasher detergent! Liquid hand-washing detergent must not be used as the foam that forms prevents the dishwasher from operating effectively.

### Dishwasher tablets

Halve the tablet if it is difficult to close the dispenser lid. There is a risk that the detergent will not be released properly if the lid is tight and cannot open correctly.

#### NOTE!

Dishwasher tablets are not recommended for short programs (less than 75 minutes). Use powder or liquid dishwasher detergent instead.

### All-in-one detergent

There are many types of all-in-one detergents on the market. Read through the directions for these products carefully.

#### NOTE!

Optimal washing and drying results are achieved by using normal dishwasher detergent together with separately dispensed rinse aid.



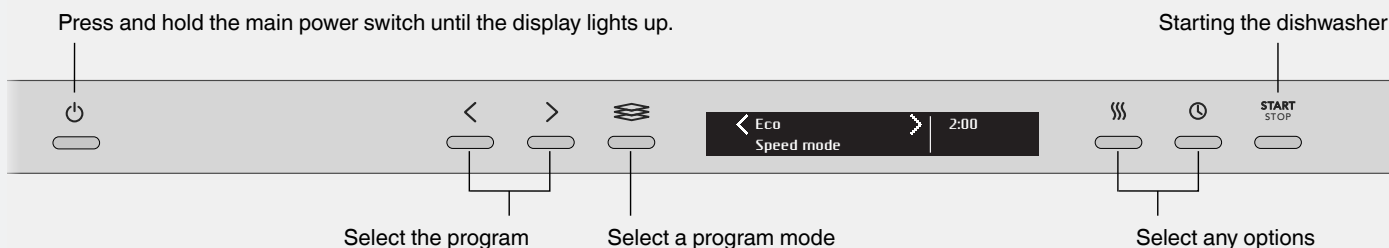

## The main power switch

Press and hold the main power switch until the display turns on. Also check that the water supply valve is on.

## Select a program

To select a program, press the Navigation button < or > until the desired program is shown on the display.

Select a program to suit the type of dishes and how dirty they are.

### **Normal wash**

This program is recommended for daily, regular, or typical use to completely wash a full load of normally soiled dishes, such as plates, serving dishes, cups, and glasses. No options are recommended.

### **ECO wash**

This program is most effective in terms of combined energy and water consumption.

### **Sanitation wash**

An effective program for daily use with slightly dried leftovers. (This program is not intended for burnt food, such as on oven dishes.)

### **Time program**

The program adapts to the specified running time or finish time. With this program, it is important to choose a time suited to how dirty the dishes are.

0:15-0:45	Lightly soiled dishes
1:00-1:30	Normally soiled dishes
2:00-2:30	Heavily soiled dishes

 – To set the desired program time, press and hold the option button to set the desired program length.

### **Rinse and hold**

Use to rinse dishes while you wait for the dishwasher to become fully loaded.

### **Plastic wash**

A program intended for washing plastic items that are dishwasher safe. This program has an extra long drying cycle. Porcelain and glasses can also be washed.

### **Hygiene wash**

This program is recommended for baby bottles and cutting boards when additional sanitation is required. The temperature is high in the main wash and in the final rinse.

### **Crystal glass**

A gentle dishwashing program with a low temperature for washing fragile items made of crystal/glass, such as crystal glass from Orrefors. Remember to use a small amount of detergent and to place items so that they do not touch each other during the wash. See also Fragile dishes in the chapter Loading the dishwasher. Porcelain that has just

been used without dried leftovers can also be washed using this program.

### **Self-cleaning**

Self-cleaning program for sanitizing the dishwasher tub, spray arms, and spray pipes.

This program should be run (with no dishes in the machine) using regular dishwasher detergent or citric acid. Special dishwasher cleaners are also available in stores. For the removal of limescale deposits, see The dishwasher tub in the chapter Care and maintenance instructions.

### **Upper half**

You can use this program if you only have cups and glasses that need washing in the upper basket. Lightly soiled dishes can also be placed in the lower basket.

### **Lower half**

You can use this program when you only want to wash plates and cutlery in the lower basket. Lightly soiled dishes can also be placed in the upper basket.

## Select a program mode

To select a program mode, press the program mode selector until the desired mode is shown on the display. The available program modes vary between programs.

For a brief description, press and hold the program mode selector.

### **Green mode**

The dishwasher uses less energy and water. The program time is extended.

### **Speed mode**

The program time is shortened, but the dishwasher uses more energy and water.

### **Night mode**

Lower noise level during the dishwashing program. The program time is extended.

### **Intensive mode (Heat Boost)**

Improves the dishwashing results, but the dishwasher uses more energy and water. The program time is extended.

## Select an Option

To select an option, press the option button until the desired option is shown on the display. The available options vary between programs.

### **Extra Dry**

A higher temperature in the final rinse and a longer drying cycle improve the drying results if you activate this option. Energy consumption is slightly increased.

For a brief description, press and hold the button for Extra Dry.

## ⌚ Delayed Start

When you select Delayed Start, the dishwasher will start 1-24 hours after you have pressed the button Start/Stop and closed the door.

- 1 Press the button once to activate Delayed Start. Press the button several times – or hold it in – to set the desired number of hours.
- 2 Press Start/Stop and close the door. The timer counts down and the dishwasher starts after the selected delay.

If you want to cancel the Delayed Start option, open the door and press and hold the main power switch until the display turns off.

## START STOP Starting the dishwasher

Press and hold Start/Stop until the display shows "Program started, close door in 4 sec". This indicates that the dishwasher is ready to start. Close the door properly within four seconds, otherwise the dishwasher will not start.

If the dishwasher is not started or the door is not closed within 2 minutes of the last button press, the machine switches off.

## Time remaining

Once you have chosen a program, program mode, and options, the time the program took when last used is displayed.

## Status light™

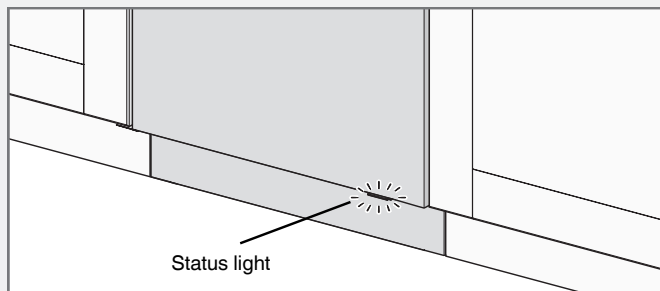

The status light at the bottom on the dishwasher provides information by means of 3 different colors.

### Blue - Load more

The program has started, but you can still load more dishes.

### Red - Do not load

You should not load more dishes (can result in poor dishwashing).

*Flashing red indicates a problem. See also the chapter Troubleshooting.*

### Green - Unload

The dishwashing program is finished. Standby light for 60 minutes.

## Stopping or changing a program

If you want to change the program after starting the dishwasher, open the door then press and hold Start/Stop for three seconds. Add more detergent if the lid of the detergent dispenser has opened. Then choose a new program, press Start/Stop, and close the door within four seconds.

## If you want to load more dishes

Open the door. The dishwasher stops automatically. Add the dishes. Press Start/Stop and close the door within five seconds.

## ⚠ WARNING!

If the door is open, "Program paused" is shown on the display. If you want the dishwashing program to continue, press Start/Stop and close the door immediately. If you want to cancel the dishwashing program, press and hold Start/Stop for three seconds.

## If the dishwasher is turned off due to a power failure

If the program was not finished, the interrupted program resumes when power is restored.

### NOTE!

During drying, the program is interrupted if the power is cut or the door is open for more than 2 minutes.

## Once the program has finished

Once the program has finished and the door is opened, "END" appears on the display.

At the end of the program, one short signal will sound. Chapter Settings describes how to change this function.

Moreover, the end of the program is indicated by the status light turning green.

The dishwasher switches off automatically after the program ends.

To minimize the risk of leaks, we recommend that you turn off the water supply valve if away from home for an extended period of time.

## How to get the best drying results

- Fully load the dishwasher.
- Angle dishes with hollows, such as cups, so that the rinse water will run off. This is also important for plastic items.
- Top up with rinse aid or increase the rinse aid dosage level.
- Activate the Extra Dry option.
- Activate the High temperature setting. See the chapter Settings.
- Open the door a little once the program has finished.
- Allow the dishes to cool before unloading the dishwasher.

## Unloading the dishwasher

Hot porcelain is more fragile. Leave the dishes to cool in the dishwasher before unloading them.

Unload the lower basket first to avoid any water drops from the upper basket falling onto the dishes in the lower basket.

## Program chart

Program	Detergent, compartment 2 (ml)	Prewashes	Main wash	Number of rinses	Final rinse	Consumption values <sup>1)</sup>					
						Cold water <sup>2)</sup>		Hot water <sup>3)</sup>		Water cons. (gallon)	
						Dishwashing time (approx. hrs:min)	Energy (approx. kWh)	Dishwashing time (approx. hrs:min)	Energy (approx. kWh)		
Normal wash <sup>4)</sup>	25	2	53 °C 127 °F	2	55 °C 131 °F	2:10	1.0	1:50	0.5	3.2	
ECO wash	25	2	55 °C 130 °F	2	50 °C 120 °F	2:30	0.9	2:05	0.6	3.7	
Sanitation wash	25	2	60 °C 140 °F	2	65 °C 150 °F	2:05	1.2	1:35	0.6	4.0	
Time program	25	0-2	<65 °C <150 °F	2-3	<65 °C <150 °F	0:15-2:30	0.5-1.6	0:15-2:30	0.4-1.2	2.9- 5.0	
Rinse and hold				1	--- °C --- °F	0:07	0.01	0:07	0.01	0.8	
Plastic wash	25	1	50 °C 120 °F	2	63 °C 145 °F	2:55	1.1	2:25	0.6	3.2	
Hygiene wash	25		70 °C 160 °F	2	70 °C 160 °F	1:30	1.4	1:00	0.9	2.6	
Crystal glass	20		45 °C 115 °F	2	50 °C 120 °F	1:50	0.8	1:20	0.5	2.4	
Upper half	20	1	60 °C 140 °F	2	60 °C 140 °F	2:20	1.0	1:50	0.6	3.2	
Lower half	20	1	60 °C 140 °F	2	60 °C 140 °F	2:20	1.0	1:50	0.6	3.2	

<sup>1)</sup> Consumption values vary depending on the temperature of the incoming water, room temperature, load size, selected additional functions, and more.

<sup>2)</sup> Connection to cold water, approx. 50 °F (10 °C). (A cold water supply is recommended.)

<sup>3)</sup> Connection to hot water, approx. 120 °F (50 °C).

<sup>4)</sup> The energy label performance figures are based on this program. This program is recommended for daily, regular, or typical use to completely wash a full load of normally soiled dishes, such as plates, serving dishes, cups and glasses. No options are recommended.

# Settings

## Open the dishwasher's Settings menu

To open the dishwasher's Settings menu, press the Navigation button < or > until Settings menu is shown on the display and confirm your selection with the mode selector .

To exit the dishwasher's Settings menu, select Exit and confirm your selection with the mode selector .

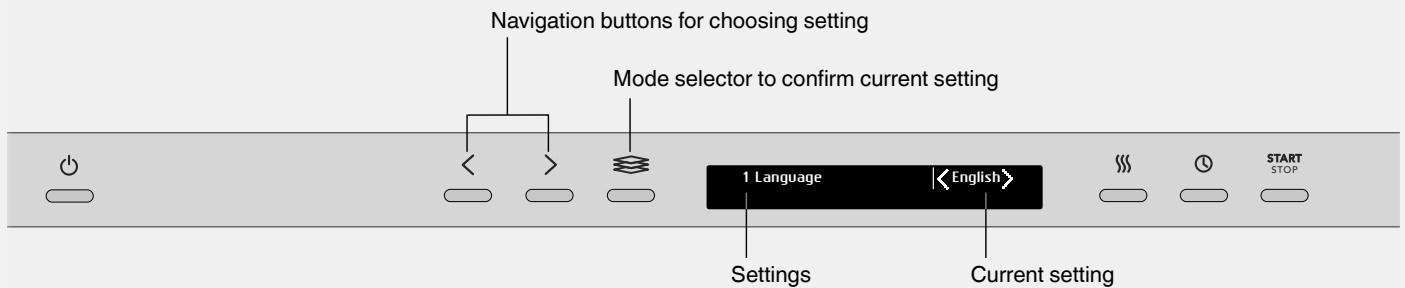

Settings	Options	
1. <b>Language</b>	English US/Svenska/Français/ Deutsch/Italiano/Suomi/Español/ Norsk/Dansk/Nederlands	You can choose the language used for the display.
2. <b>Select programs</b>	Normal wash <i>On/Off</i> ECO wash <i>On/Off</i> Sanitation wash <i>On/Off</i> Time program <i>On/Off</i> Rinse and hold <i>On/Off</i> Plastic wash <i>On/Off</i> Hygiene wash <i>On/Off</i> Crystal glass <i>On/Off</i> Self-cleaning <i>On/Off</i> Lower half <i>On/Off</i> Upper half <i>On/Off</i>	Programs can be shown or hidden in the menu. Choose between On and Off. (ECO wash cannot be hidden in the menu.)
3. <b>Child lock</b>	<i>On/Off</i>	You can activate the child lock (button lock) to prevent children from starting the dishwasher.  <  To temporarily deactivate and activate the child lock, press and hold the left Navigation button and the option button Delayed Start for 3 seconds.
4. <b>Display settings</b>	Contrast top display 1/2/3/4	For adjusting the contrast of the display.
	Logo in top display <i>On/Off</i>	Setting to hide the logo shown on the display.
5. <b>Feedback sound</b>	0/1/2/3	This sound is used to confirm each button press.
6. <b>Buzzer volume</b>	0/1/2/3	The buzzer indicates when a dishwashing program has ended. <i>Error messages are always indicated by a loud buzzer.</i>
7. <b>Rinse aid</b>	0/1/2/3/4/5	Setting for rinse aid dosage. The rinse aid dispenser can be adjusted between 0 (Off) and 5 (High dosage). Increase the rinse aid dosage: <ul style="list-style-type: none"> <li>• If the dishes have water marks.</li> </ul> Reduce the rinse aid dosage: <ul style="list-style-type: none"> <li>• If the dishes have a sticky white/blue film.</li> <li>• If the dishes are streaked.</li> <li>• Heavy foaming. If you have very soft water, the rinse aid can be diluted 50:50 with water.</li> </ul>

Settings		Options	
8.	<b>Super rinse</b>	<i>On/Off</i>	<p>Super rinse adds two extra rinses.</p> <p><i>Activated in the following programs:</i></p> <p><i>Normal wash</i></p> <p><i>ECO wash</i></p> <p><i>Sanitation wash</i></p> <p><i>Plastic wash</i></p> <p><i>Lower half</i></p> <p><i>Upper half</i></p>
9.	<b>High temperature</b>	<i>On/Off</i>	<p>Activate the setting High temperature to improve the dishwashing results. Energy consumption is slightly increased.</p> <p><i>Activated in the following programs:</i></p> <p><i>Normal wash</i></p> <p><i>ECO wash</i></p> <p><i>Sanitation wash</i></p> <p><i>Plastic wash</i></p> <p><i>Lower half</i></p> <p><i>Upper half</i></p>

# Care and maintenance instructions

## Coarse filter

The coarse filter traps larger food particles, which cannot get past the drain pump. Empty the coarse filter as necessary.

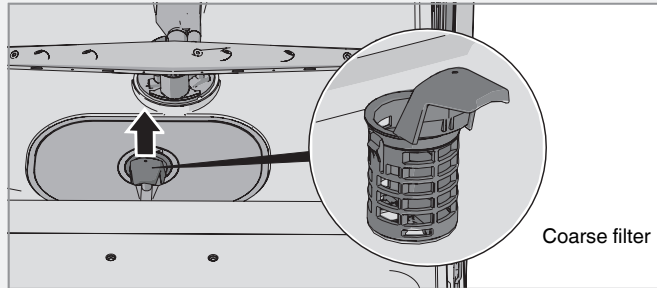

- 1 Lift the coarse filter by the handle.
- 2 Empty the coarse filter. Remember to replace it!

## Fine filter

Debris that collects on the fine filter is automatically rinsed away during each wash. Clean the fine filter when necessary.

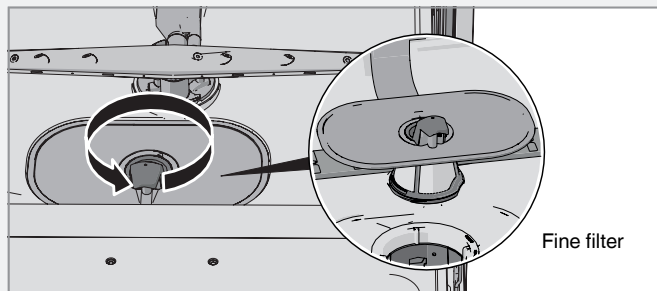

- 1 Turn the handle counterclockwise.
- 2 Lift the filter straight up using the handle. Remove the coarse filter to clean the fine filter.
- 3 Replace in reverse order. Check that the edges seal properly when replacing the fine filter.
- 4 Lock the filter in place by turning the handle clockwise to the stop position. The handle should point straight out from the dishwasher.

### NOTE!

The dishwasher must not be used without the filters in place!  
Dishwashing results may be affected if the coarse filter is incorrectly fitted.

## Spray arms and spray pipes

Holes and bearings can become blocked. Remove debris using a needle or similar item. The spray arms have holes on the bottom.

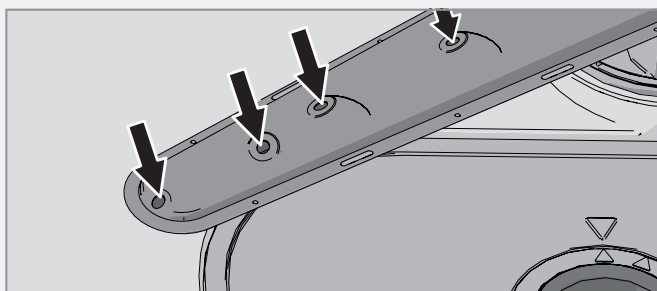

Spray arms can be removed for cleaning. Remember to fit them firmly back into place afterward.

### Upper spray arm

- 1 Pull out the upper basket.

- 2 Unscrew the spray arm bearings counterclockwise to remove the spray arm from the upper basket.

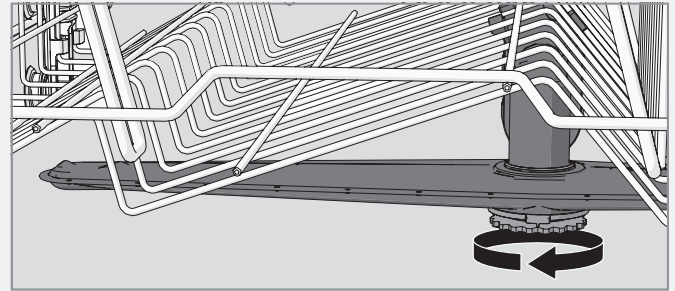

### The middle spray pipes

- Pull out the middle basket.
- Check the holes in the spray pipes.

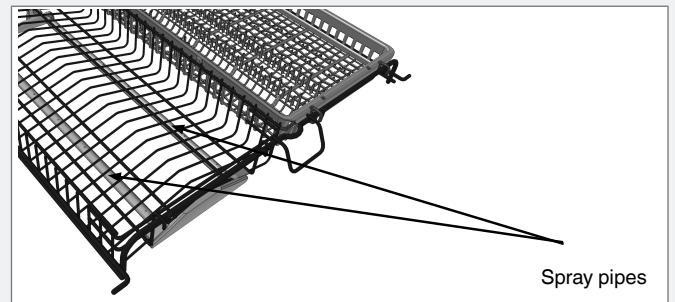

### Lower spray arm

- Pull the lower spray arm straight up to release it.

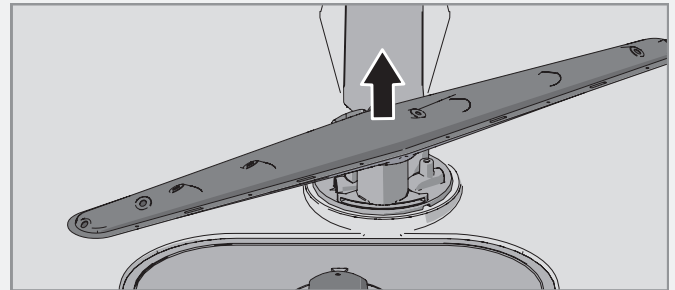

## The door and the door seal

Regularly clean the sides of the door and the door seal. Use a slightly damp cloth (with a little cleaner if necessary).

## Display panel

Keep the buttons clean and free from grease. Wipe them clean with a dry or slightly damp cloth. Never use cleaners – they can scratch the surface. Use the main power switch to turn off the dishwasher before cleaning the buttons to avoid activating any buttons unintentionally.

## The dishwasher tub

The dishwasher tub is made of stainless steel and is kept clean through normal use.

### Limescale deposits

If you have hard water, limescale deposits may build up in the dishwasher. If this happens, run the Self-cleaning program with two tablespoons of citric acid in the detergent compartment (with no dishes in the machine). Special dishwasher cleaners are also available in stores.

Never use anti-freeze, Draino®, CLR®, or other chemical cleaners.

## Unblocking the drain pump

If the dishwasher still contains water after the program has finished, something may be blocking the drain pump. Such items are easily removed.

- 1 Turn off the machine using the main power switch and unplug it from the power outlet.
- 2 Remove the coarse filter and the fine filter.
- 3 Scoop out the water from the dishwasher tub.
- 4 In order to inspect the drain pump, remove the colored stop on the right in the bottom drain.
- 5 Turn the pump wheel located behind the drain pump stop by hand. Carefully remove any items.
- 6 Replace the drain pump stop along with the fine and coarse filters.
- 7 Plug the machine in again.

If the dishwasher still does not start and a whirring sound is heard, the overflow protection has been triggered.

- Shut off the water.

- Unplug the unit from the power outlet.
- Call the Customer Care Center.

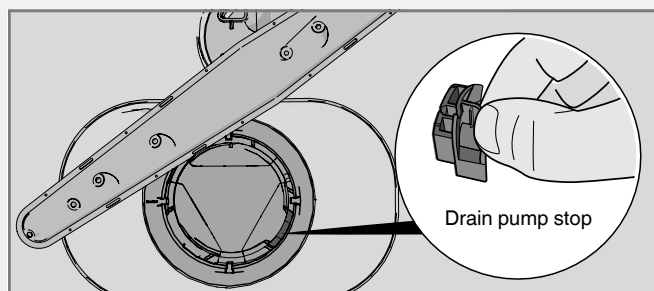

### NOTE!

Do not forget to replace the drain pump stop.

# Troubleshooting

Type of fault on the display		Action
<b>F10</b>	Overfilling water 1	Clear the drain pump. See the section Care and maintenance instructions. If the problem persists, call the Customer Care Center.
<b>F11</b>	Water outlet fault	See "Water remains in the dishwasher above the filters" in the table "Problem" below. If the problem persists, call the Customer Care Center.
<b>F12</b>	Water inlet fault	Check that the water supply valve is on. If the problem persists, call the Customer Care Center. The water pressure should be 4.2-140 psi.
<b>F40</b>	Inlet valve leakage	Turn off the water supply valve and call the Customer Care Center.
<b>F52</b>	Water level fault	Call the Customer Care Center.
<b>F54</b>	Overfilling water 2	Turn off the water supply valve and call the Customer Care Center.
<b>F56</b>	Circ. pump fault	Call the Customer Care Center.

Press any button to clear the error message.

Problem	Possible causes	Action
The buttons do not react when pressed.	You have pressed the buttons too soon after opening the door.	Wait a moment then try again.
	Child lock (button lock) activated.	See the chapter Settings.
	The door is closed.	Open the door. The buttons only react to use when the door is open.
	The buttons are dirty.	Clean with a dry or slightly damp cloth.
Cannot close door.	The baskets are not correctly positioned.	Check that the baskets are correctly positioned horizontally, and that the middle basket's water connector is in line with its spray pipe.
		Check that the dishes are not blocking the baskets from sliding properly into place.
The dishwasher does not start.	The Start/Stop start button has been pressed for too short a time.	Press and hold Start/Stop until the display shows "Program started, close door in 4 sec".
	The door is not closed properly or was not closed immediately after pressing the Start/Stop button.	Close the door within four seconds, otherwise the dishwasher will not start.
	You have opened the dishwasher to add more dishes while a program is in progress.	If you want the dishwashing program to continue, press Start/Stop and close the door within five seconds.
	A fuse/circuit breaker has been tripped.	Check.
	The plug is not plugged into the power outlet.	Check.
	The water supply valve is turned off.	Check.
	Overflow/leaks.	Check.
	A whirring sound (the drain pump) is heard from the dishwasher and does not stop when the main power switch is turned off.	Turn off the water supply valve. Pull out the plug and call the Customer Care Center.
Check that the Delayed Start option has not been selected.	Press and hold Start/Stop for three seconds if you want to cancel the Delayed Start option.	



<b>Problem</b>	<b>Possible causes</b>	<b>Action</b>
The dishes are not clean.	The spray arms do not rotate.	Check that the dishes are not blocking the spray arms.
	Spray arm holes or bearings blocked.	Clean the spray arms and the middle basket's spray pipe. See the chapter Care and maintenance instructions.
	Unsuitable dishwashing program.	Choose a longer program.
	Incorrect detergent dosage.	Dose according to water hardness. Far too much or far too little detergent can result in poor dishwashing results.
	Detergent is too old. Detergent is a perishable product.	Avoid large packages.
	Dishes loaded incorrectly.	Do not cover dishes with large bowls or lids. Avoid placing very tall glasses in the corners of the baskets.
	Glasses and cups have toppled over during the program.	Load the dishes securely.
	The filters are not fitted correctly.	Check that the filter handle is locked in the stop position. The handle should point straight out from the dishwasher.
Spots on stainless steel or silver.	Some types of food, such as mustard, mayonnaise, lemon, vinegar, salt, and dressings, can mark stainless steel if left for too long.	Rinse off these types of food if not starting the dishwasher immediately. Use the Rinse and hold program.
	All stainless steel can cause spots on silver if they come into contact during dishwashing. Aluminum can also cause spots on dishes.	In order to avoid marks and tarnishing, separate dishes made from different metals, such as silver, stainless steel, and aluminum.
Spots or films on the dishes.	Incorrect rinse aid dosage setting.	See the chapter Settings.
	Too high temperature and/or too much detergent can cause etching on crystal. Unfortunately, this cannot be repaired, only prevented.	Wash crystal at a low temperature and with a conservative amount of detergent. Contact the detergent manufacturer.
The dishes have a sticky white/blue film.	Rinse aid dosage setting too high.	Reduce the dosage. See the chapter Settings. If you have very soft water, you may want to dilute the rinse aid 50:50 with water.
Spots left after washing.	Lipstick and tea can be difficult to wash off.	Use a detergent with a bleaching agent.
Detergent residue in the detergent compartment after dishwashing.	The detergent compartment was damp when adding detergent.	The detergent compartment must be dry when adding detergent.
	The detergent compartment has been blocked.	Check that the dishes are not preventing the detergent compartment from opening.
Rattling sound when dishwashing.	The dishes are not correctly placed or the spray arms are not rotating.	Check that the dishes are placed securely. Spin the spray arms to make sure they can rotate.
"Program paused" is shown on the display.	The dishwasher door has been opened while a program is in progress.	If you want the dishwashing program to continue, press Start/Stop and close the door within five seconds.  If you want to cancel the dishwashing program, press and hold Start/Stop for three seconds.

<b>Problem</b>	<b>Possible causes</b>	<b>Action</b>
Water remains in the dishwasher above the filters.	The filters are blocked.	Clean the coarse and fine filters.
	The filters are not fitted correctly.	Check that the filter handle is locked in the stop position. The handle should point straight out from the dishwasher.
	Debris in the drain pump.	Clean the drain pump. See the chapter Care and maintenance instructions.
	Kink in drain hose.	Check that the hose is free from kinks and sharp bends.
	Blocked drain hose.	Loosen the drain hose from where it terminates. Check that no debris has clogged the hose. Is the cone-shaped part of the drain boot cut to the maximum size of the fitting where it attaches?
Bad odor in dishwasher.	Dirt around the seals and in corners.	Clean with dish brush and low foaming cleaner.
	Low temperature programs have been selected for a prolonged period.	Run a program with a higher temperature once or twice a month. Or run a self-cleaning program. See Self-cleaning in the chapter Using the dishwasher.
	The dishwasher is connected to a garbage disposer.	Cleaning the garbage disposer connected to the dishwasher can eliminate odors. Follow the disposer manufacturer's cleaning instructions.
The dishes are not dry enough.	Depending on the load, the program's drying cycle may be insufficient.	Activate the Extra Dry option.
	The dishwasher is not fully loaded.	Fully load the dishwasher.
	Rinse aid needs topping up or dosage is set too low.	Top up with rinse aid or increase the rinse aid dosage level. See the chapter Settings.
		Open the door a little once the program has finished.

# Technical information

## Technical data

Height:	33 7/8 -36"
Width:	23 1/2" <sup>1)</sup>
Depth:	22"
Weight:	110 lb (50 kg) <sup>2)</sup>
Water pressure:	4.2-140 psi
Electrical connection:	See serial number plate
Rated power:	See serial number plate

1) *24" with the trim kit.*

2) *Weight can vary due to different specifications.*

# Installation instructions

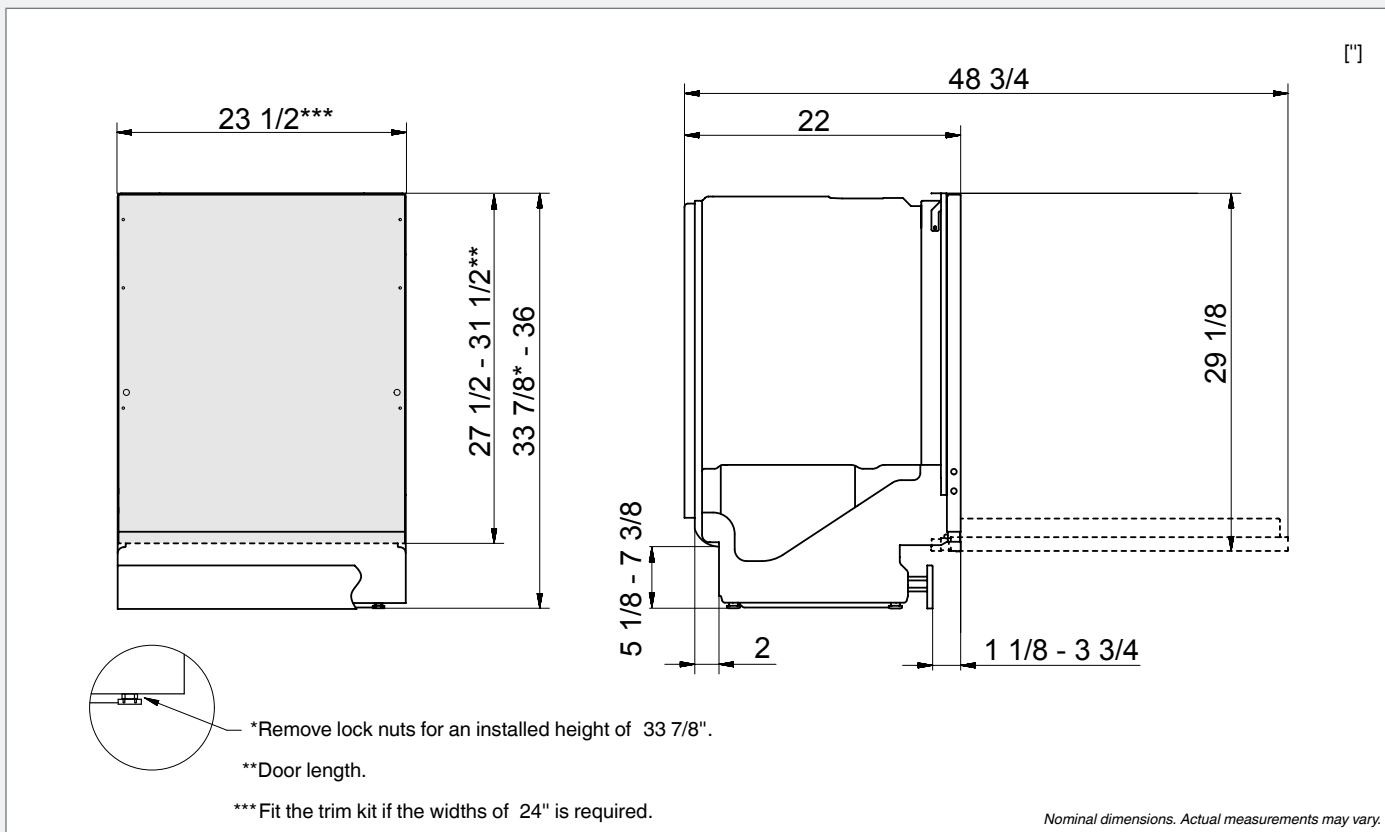

It is important that you read through and follow the instructions and directions below. Conduct installation and connection in accordance with the separate installation instructions.

## Important safety instructions

- Connections to electricity, water, and drainage must be performed by a qualified professional.
- Always follow applicable regulations for water, drainage, and electricity.
- Take care during installation! Wear protective gloves! There must always be two people!
- Place a drip tray on the floor beneath the dishwasher to prevent damage from any water leaks.
- Before screwing the dishwasher into place, test the dishwasher by running the Rinse and hold program. Check that the dishwasher fills with water and drains. Also check that none of the connections leak.

### **! WARNING!**

Turn off the water supply when installing the dishwasher!

The plug must be disconnected or power to the outlet turned off while installing the dishwasher!

## Setup

- The recess and connection dimensions are included in the separate installation instructions. Check that all dimensions are correct before starting the installation. Note that the height of the integrated door panel can be adjusted to match other fittings.

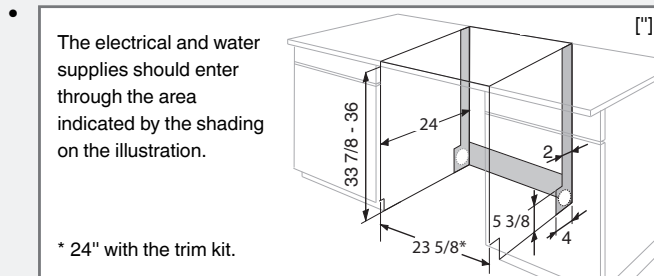

- Make sure the area on which the dishwasher is to be installed is firm. Adjust the adjustable feet so that the dishwasher is level. Tighten the lock nuts.
- Stronger door springs are available for purchase for dishwashers with a fitted wooden door panel. Springs are available for various weights and sizes of wooden door panel. Door springs can be purchased from the retailer who sold you the dishwasher.

### NOTE!

Framed cabinets require additional finished filler material behind the face frame for a proper installation. A minimum 3 1/2" (89 mm) finished return is required on all sides of the opening.

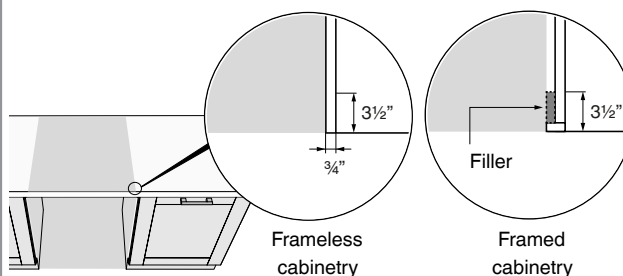

## Drain connection

See the separate installation instructions for necessary information.

This dishwasher is suitable for installing in a raised recess (to attain an ergonomic working height). This means that the dishwasher can be placed so that the drain hose runs to a lower level than the bottom of the dishwasher, such as by routing it directly to a floor drain. The dishwasher is fitted with an integrated anti-siphon device to prevent the machine from being emptied of water during the wash cycle.

The drain hose can also be connected to a connection nipple on the sink's water trap. The connection nipple must have an internal diameter of at least 1/2". The water trap must be ventilated.

The drain hose may be extended by a maximum of 87" (2.2 m) (the total length of the drain hose must not exceed 177" (4.5 m)). Any joins and connecting pipes must have an internal diameter of at least 1/2". However, the drain hose should ideally be replaced with a new hose without joins.

No part of the drain hose may be more than 37 3/8" above the bottom of the dishwasher.

Attach the drain hose with a hose clamp. Ensure that the drain hose has no kinks.

## Connection to water supply

Use only the inlet hose supplied with the dishwasher. Do not re-use old or other spare hoses.

The supply pipe must be fitted with a water supply valve. The water supply valve must be easily accessible, so that the water can be shut off if the dishwasher has to be moved.

Once the installation is complete, turn on the water supply valve and allow the pressure to settle for a while. Check that all connections are watertight.

### Water supply

The machine can be connected to either a cold or a hot (max. 160 °F (70 °C)) water supply. The water pressure should be 4.2-140 psi.

### Connection to cold water supply

Connect the dishwasher to the cold water supply if the building is heated using oil, electricity, or gas.

### Connection to hot water supply

Connect the dishwasher to the hot water supply (max. 160 °F (70 °C)) if the building is heated using an energy-efficient means such as district heating, solar power, or geothermal power. Choosing a hot water connection cuts dishwashing times and reduces the dishwasher's energy consumption.

### NOTE!

Do not exceed the permitted water supply temperature. Certain materials used in some cookware cannot withstand strong heat. See Fragile dishes in the chapter Loading the dishwasher.

## Electrical connection

Information about the electrical connection can be found on the serial number plate. This specification must match the electricity supply.

The power supply receptacle for the appliance must be installed in a cabinet or on a wall adjacent to the undercounter space in which the appliance is to be installed. Do not use an extension cord for this appliance.

The access hole for the the electrical supplie must be round and smooth and no bigger than 1 1/2" in diameter. If the partition is metal, it needs to be covered with an edge protector.

Use caution when the appliance is installed or removed to reduce the likelihood of damage to the power supply cord.

## Grounding Instructions

This appliance must be grounded. In the event of a malfunction or breakdown, grounding will reduce the risk of electric shock by providing a path of least resistance for electric current. This appliance is equipped with a cord fitted with an equipment grounding conductor and a grounding plug. The plug must be plugged into an appropriate outlet that is installed and grounded in accordance with all local codes and ordinances.

### WARNING!

Improper connection of the equipment grounding conductor can result in a risk of electric shock. Check with a qualified electrician or service representative if you are in doubt as to whether the appliance is properly grounded. Do not modify the plug provided with the appliance. If it does not fit the outlet, have an appropriate outlet installed by a qualified electrician.

## Limited Warranty – Residential Appliances

ASKO Distribution North America, LLC. (“ASKO”) warrants to the original purchaser (the “ASKO Customer”) of the ASKO product (the “ASKO Product”), who purchased the ASKO Product from a distributor, dealer, manufacturer’s representative or other seller who has been authorized by ASKO, that this ASKO Product is free of defects in materials and/or workmanship, subject to the terms and conditions set forth herein. This Limited Warranty covers parts and labor, except as set forth in this Limited Warranty. Service must be provided by an authorized ASKO service company. YOUR SOLE AND EXCLUSIVE REMEDY UNDER THIS LIMITED WARRANTY SHALL BE PRODUCT REPAIR AS PROVIDED HEREIN. This Limited Warranty is valid only when the ASKO Product is used in the country in which it was purchased. Proof of original purchase date is required to obtain service under this Limited Warranty.

### Residential ASKO Products Used Exclusively for Household/Personal Purposes:

Two (2) Years limited Warranty – Any warranty service claims for residential ASKO Products must be filed with ASKO within two (2) years from date of purchase. Service will be provided during normal business hours.

### Residential ASKO Products Not Used Exclusively for Household/Personal Purposes or used Commercially or used in Marine, Mobile or Aeronautical Applications:

One (1) Year limited Warranty – Any warranty service claims for ASKO Products not used exclusively for household and personal use, or used commercially or used in marine, mobile, or aeronautical applications must be filed with ASKO within one (1) year from date of purchase. Service will be provided during normal business hours.

## Items excluded from warranty

### This limited warranty does not cover:

- 1 Replacement parts or repair labor if the ASKO Product is used in a manner that is inconsistent with published user or operator instructions and/or installation instructions.
- 2 Service calls to correct the installation of the ASKO Product, to instruct you on how to use the ASKO Product, to replace or repair house fuses, or to correct house wiring or plumbing.
- 3 Consumable items and parts, such as filters.
- 4 Damage resulting from accident, alteration, misuse, abuse, negligence, fire, flood, acts of God, improper use, improper installation, installation not in accordance with electrical or plumbing codes, or use of products not approved by ASKO, as well as any attempted repair by other than authorized ASKO service companies.
- 5 Cosmetic damage, including scratches, dents, chips or other damage to the finish of the ASKO Product, unless such damage results from defects in materials or workmanship and is reported to ASKO within 5 days from date of purchase.
- 6 Pickup and delivery. The ASKO Product is intended to be repaired in your home.
- 7 Repairs to parts or systems resulting from unauthorized modifications made to the ASKO Product.
- 8 Expenses for travel and transportation for product service if the ASKO Product is located in a remote area where service by an authorized ASKO service company is not available.
- 9 The removal and reinstallation of the ASKO Product if it is installed in an inaccessible location or is not installed in accordance with ASKO’s published installation instructions.
- 10 Replacement parts or repair labor on ASKO Products with original model/serial numbers that have been removed, altered or cannot be easily determined.

## Disclaimer

YOUR SOLE AND EXCLUSIVE REMEDY UNDER THIS LIMITED WARRANTY SHALL BE PRODUCT REPAIR AS PROVIDED HEREIN. EXPRESSLY DISCLAIMED ARE ALL OTHER EXPRESS AND IMPLIED WARRANTIES, INCLUDING ANY IMPLIED WARRANTIES OF MERCHANTABILITY AND FITNESS FOR A PARTICULAR PURPOSE. Some jurisdictions do not allow exclusion or limitations regarding warranty rights. This Limited Warranty gives you specific legal rights and you may have other rights that vary from jurisdiction to jurisdiction. Attempted repair by any person other than an authorized ASKO service company will void this Limited Warranty.

## Limitation of liability

IN NO EVENT SHALL ASKO OR THE MANUFACTURER AND THEIR RESPECTIVE PARENTS, SUBSIDIARIES AND AFFILIATES BE LIABLE FOR CONSEQUENTIAL, INCIDENTAL, EXEMPLARY, PUNITIVE OR SPECIAL DAMAGES. IN NO EVENT SHALL ASKO OR THE MANUFACTURER AND THEIR RESPECTIVE PARENTS, SUBSIDIARIES AND AFFILIATES BE LIABLE FOR DAMAGES OTHER THAN ACTUAL DAMAGES AND IN NO EVENT FOR DAMAGES IN EXCESS OF THE PRICE PAID FOR THE ASKO PRODUCT AS TO WHICH A CLAIM IS MADE. Some jurisdictions do not allow the exclusion or limitation of incidental, consequential or other damages, so these limitations and exclusions may not apply to you. This Limited Warranty gives you specific legal rights. You also may have other rights that vary from jurisdiction to jurisdiction.

## Troubleshooting & ASKO Customer Care

If you think you need repair service, first see the Troubleshooting section of the Use & Care Guide. If you are unable to resolve the problem after checking Troubleshooting, then additional help can be obtained by calling ASKO Customer Care at 1-800-898-1879.

Read the chapter Troubleshooting before contacting the Customer Care Center. If you have encountered a problem that you cannot resolve, please contact your nearest dealer, see [www.asko.com](http://www.asko.com).

When making contact, provide the details on the serial number plate. Include the service number (1), the article number (2), and the serial number (3).

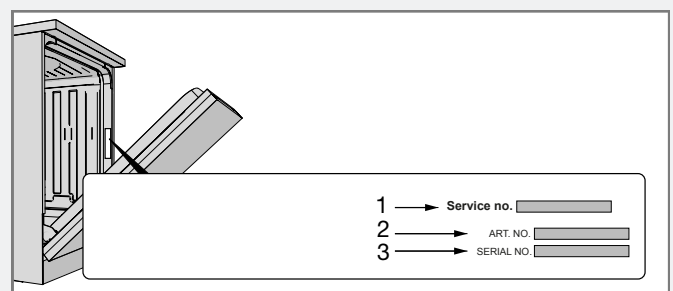

## Service after expiration of limited warranty

For information about obtaining parts and labor after expiration of this Limited Warranty or arising outside the scope of this Limited Warranty, please contact ASKO Customer Care at 1-800-898-1879. After your purchase and prior to first use of the ASKO Product, register your ASKO Product with ASKO by utilizing the address information below. Should you need further assistance as well, contact us at the address information below:

ASKO Distribution North America, LLC  
Customer Care Center, PO Box 44848, MADISON WI 53744



# Quick start guide

1.

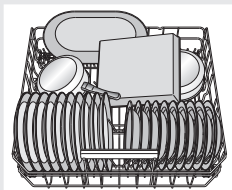

## Load the baskets

(See page 5.)

Do not rinse dishes under running water before loading them in the dishwasher. Simply scrape off large food particles before loading the dishwasher.

2.

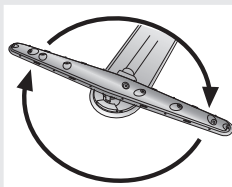

## Check that the spray arms can rotate freely

Check also that the water supply valve is on.

Don't forget! Empty the coarse filter and clean the fine filter when necessary. (See page 14.)

3.

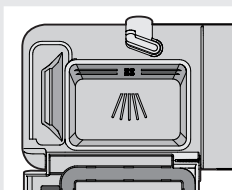

## Add detergent

The detergent compartment has a small compartment for prewash and a large compartment for the main wash. (See page 8.)

4.

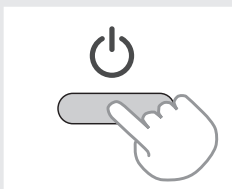

## Press and hold the main power switch until the display lights up

5.



## Check/Add rinse aid

Top up rinse aid for optimal washing and drying results. (See page 4.)

 Refill rinse aid indicator.

6.

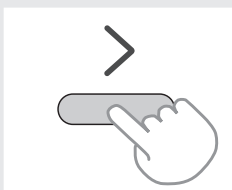

## Select a program, program mode, and any options

(See page 9.)

7.

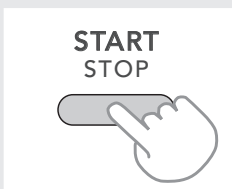

## Press Start/Stop, close the door

Press and hold Start/Stop until the display shows "Program started, close door in 4 sec". This indicates that the dishwasher is ready to start. Close the door properly within four seconds, otherwise the dishwasher will not start.

# ASKO