

ASSEMBLY INSTRUCTIONS
COASTER FINE FURNITURE

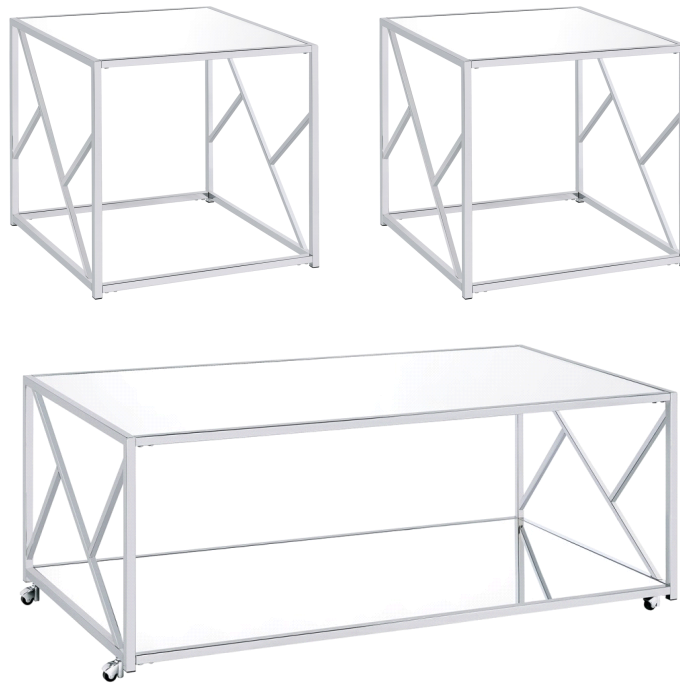

Fine Furniture for every stage of life

720794
3PC OCCASIONAL SET

REVISION 0 : 12/16/2020
REVISION 1 : 03/08/2021
REVISION 2 : 07/22/2021

ITEM:720794



ASSEMBLY INSTRUCTIONS

ASSEMBLY TIPS:

1. Remove hardware from box and sort by size.
2. Please check to see that all hardware and parts are present prior to start of assembly.
3. Please follow attached instructions in the same sequence as numbered to assure fast & easy assembly.



WARNING!

1. Don't attempt to repair or modify parts that are broken or defective. Please contact the store immediately.
2. This product is for home use only and not intended for commercial establishments.

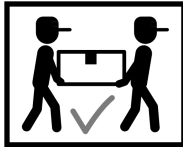

ASSEMBLY TIME 60 MINUTES

PARTS IDENTIFICATION

AN COFFEE TABLE MIRROR 2PCS

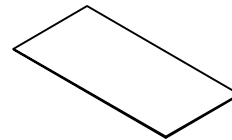

B COFFEE TABLE FRAME A 1PC

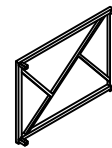

C COFFEE TABLE FRAME B 1PC

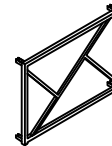

DN COFFEE TABLE CROSSBAR 4PCS

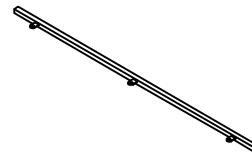

EN END TABLE MIRROR 2PCS

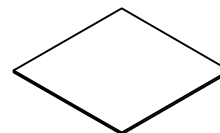

F END TABLE FRAME A 2PCS





ITEM:720794

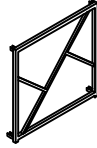
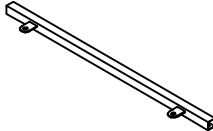
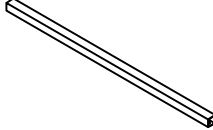

ASSEMBLY INSTRUCTIONS

PARTS IDENTIFICATION

G	END TABLE FRAME B		2PCS
HN	END TABLE TOP CROSSBAR		4PCS
I	END TABLE BOTTOM CROSSBAR		4PCS
J	CASTER		4PCS

HARDWARE IDENTIFICATION

1	BOLT (1/4" x 12mm SR)		40PCS
2	SUCTION CUP (ϕ 5mm)		20PCS
3	CAP (18 x 18mm BLK)		12PCS
4	ALLEN KEY (4mm)		1PC

ITEM: 720794

ASSEMBLY INSTRUCTIONS

COFFEE TABLE

STEP 1 Do not tighten until each step is completed or instructed.

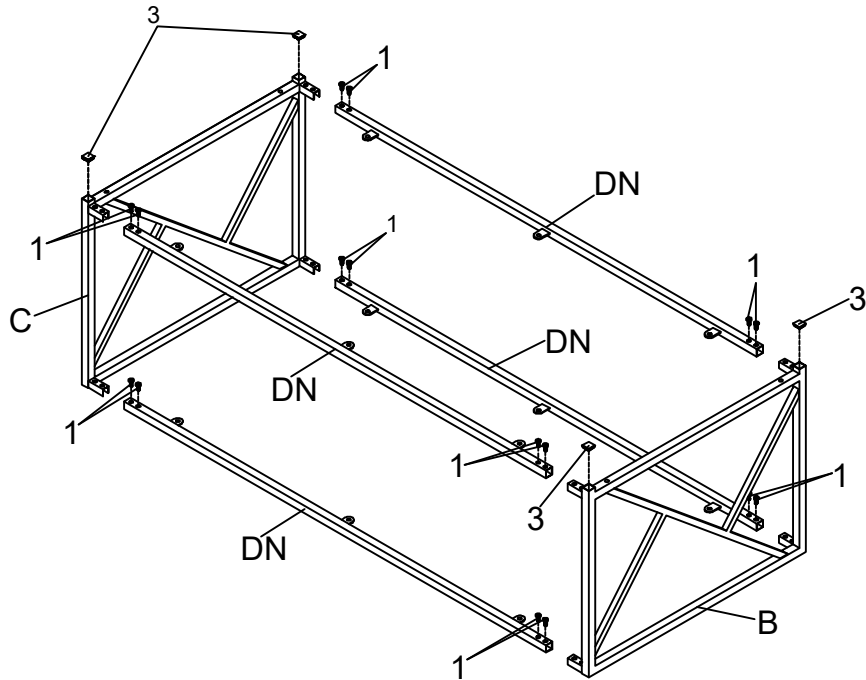

STEP 2

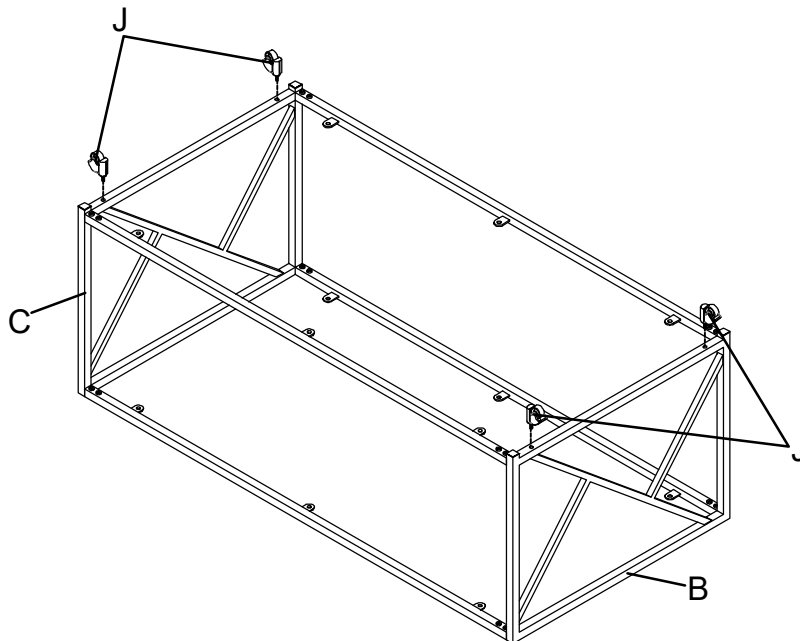

ITEM:720794

ASSEMBLY INSTRUCTIONS

STEP 3

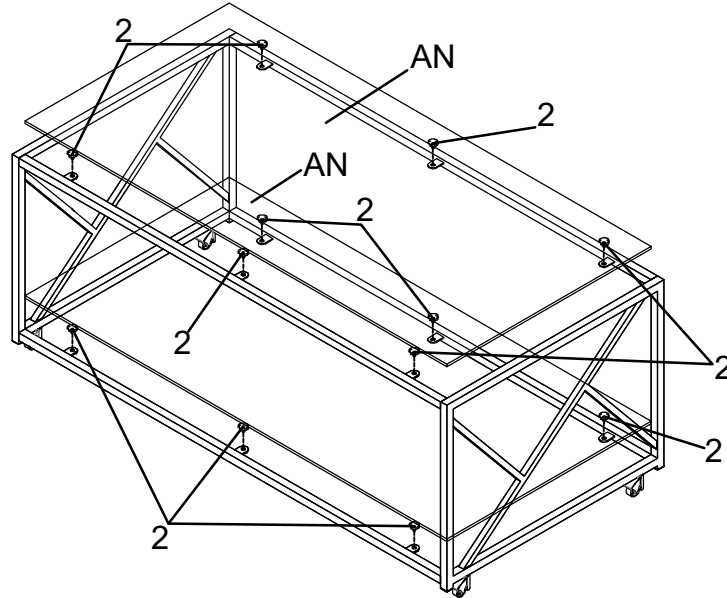

END TABLE STEP 4

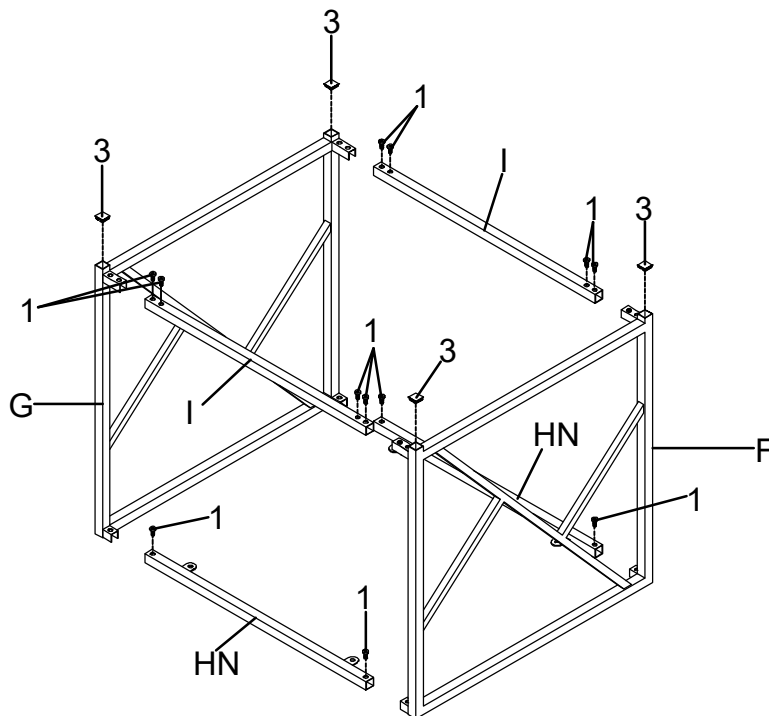

ITEM: 720794
ASSEMBLY INSTRUCTIONS
STEP 5

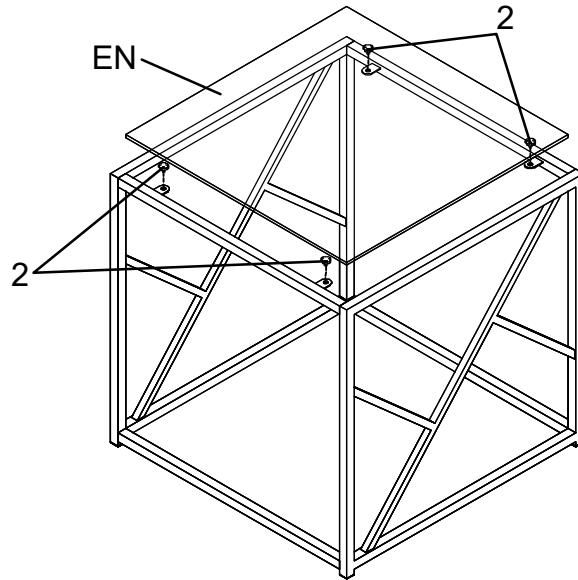

STEP 6
COMPLETE

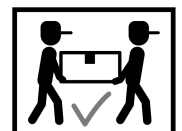
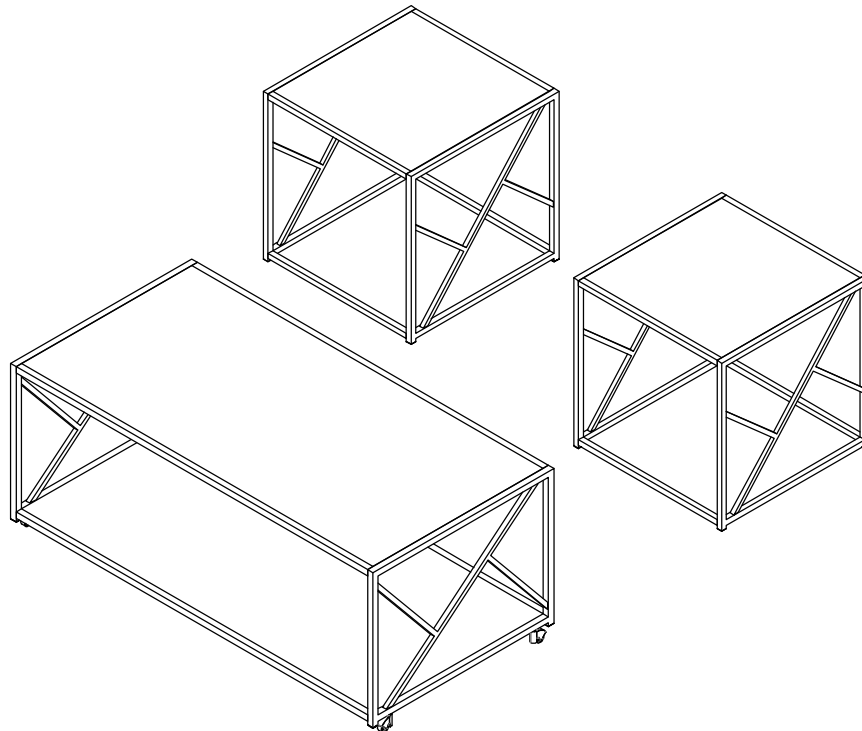

ITEM: 720794 ASSEMBLY INSTRUCTIONS



Product Size : 1200 X 597 X 483 H (MM)
Product Size : 47.25" X 23.5" X 19"

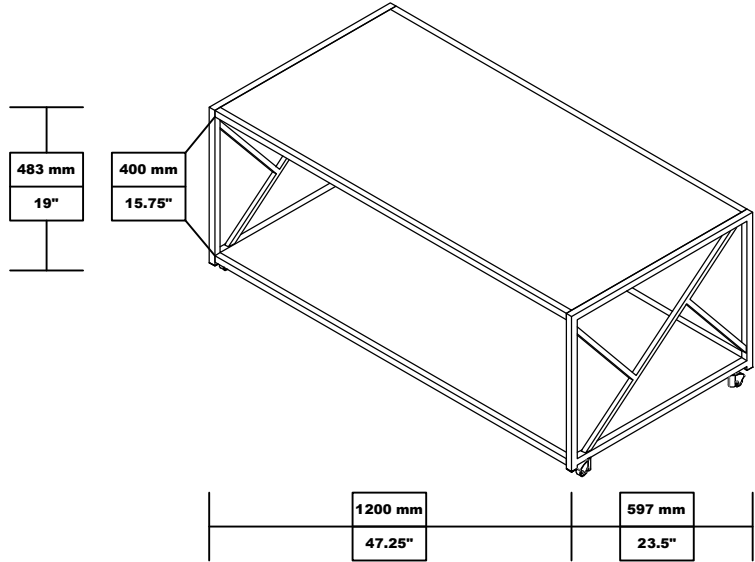

Product Size : 559 X 559 X 559 H (MM)
Product Size : 22" X 22" X 22"

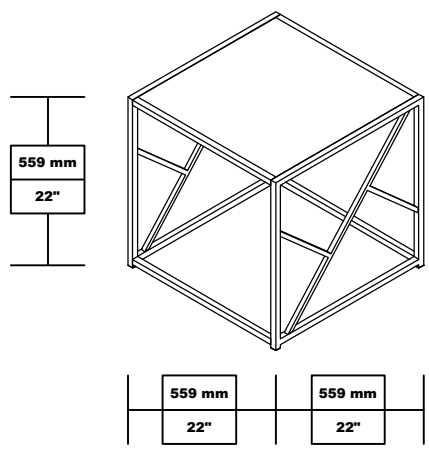

Note : Dimension tolerance $\pm 5\%$