



**INSTRUCTIONS D'ASSEMBLAGE**  
**ASSEMBLY INSTRUCTIONS**

---

**M**ONARCH  
SPECIALTIES INC.

# I 5922F

---

**LIT -**  
**DOUBLE / SIMILI-CUIR BRUN FONCE**

**BED -**  
**FULL SIZE / DARK BROWN LEATHER-LOOK**



**POUR DE L'ASSISTANCE OU POUR COMMANDER  
DES PIÈCES CONTACTEZ NOTRE DÉPARTEMENT  
DE SERVICE À LA CLIENTÈLE.**



**FOR ASSISTANCE OR TO ORDER PARTS  
CONTACT OUR CUSTOMER SERVICE DEPARTMENT**

**WWW.MONARCHSERVICE.COM**

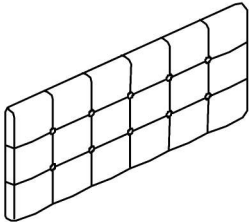
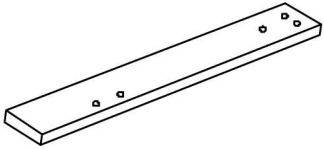
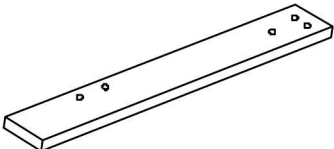
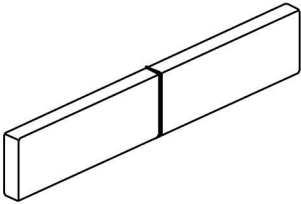
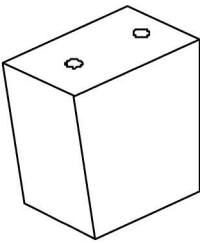

**LISTE DES PIÈCES**  
**PARTS LIST**

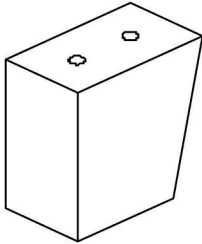
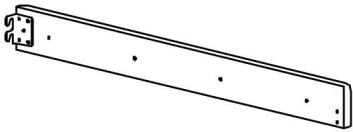
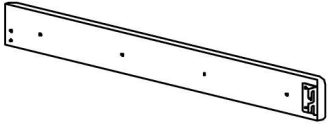
PIÈCE / PART #	IMAGE	DESCRIPTION	QTY / QTÉ
1		HEADBOARD TÊTE DE LIT	1
2		FRONT FACING HEADBOARD LEFT LEG TÊTE DE LIT AVANT GAUCHE	1
3		FRONT FACING HEADBOARD RIGHT LEG TÊTE DE LIT AVANT DROITE	1
4		FOOTBOARD PIED DE LIT	1
5		FRONT FACING FOOTBOARD LEFT LEG PIED DE LIT AVANT GAUCHE	1

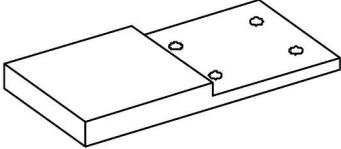

**LISTE DES PIÈCES**  
**PARTS LIST**

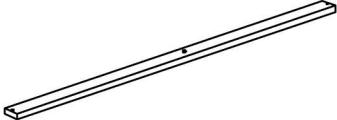
PIÈCE / PART #	IMAGE	DESCRIPTION	QTY / QTÉ
6		FRONT FACING FOOTBOARD RIGHT LEG PIED DE LIT AVANT DROIT	1
7		FRONT FACING LEFT SIDE RAIL RAIL DE CÔTÉ GAUCHE	2
8		FRONT FACING RIGHT SIDE RAIL RAIL DE CÔTÉ DROIT	2
9		SUPPORT BAR BARRE DE SOUTIEN	4
10		SIDE RAIL SUPPORT LEG RAIL DE CÔTÉ PATTE DE SOUTIEN	2

**LISTE DES PIÈCES**  
**PARTS LIST**

PIÈCE / PART #	IMAGE	DESCRIPTION	QTY / QTÉ
11		SLAT LAMELLE	4
12		SUPPORT LEG PATTE DE SOUTIEN	4

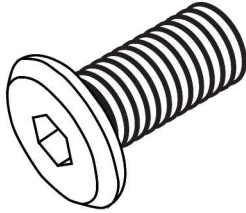
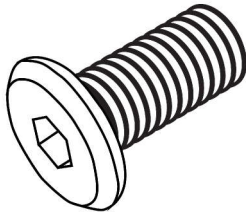
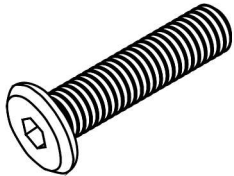
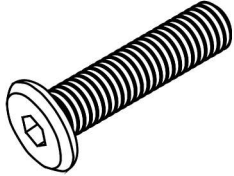
**LISTE DES PIÈCES DE MONTAGE**  
**HARDWARE LIST**

PIÈCE / PART #	IMAGE	DESCRIPTION	QTY / QTÉ
<b>A</b>		<b>ASSEMBLING BOLT - Ø 3/8" X 3/4"</b>  <b>BOULON D'ASSEMBLAGE - Ø 3/8" X 3/4"</b>	<b>8</b>
<b>B</b>		<b>ASSEMBLING BOLT - Ø 1/4" X 1"</b>  <b>BOULON D'ASSEMBLAGE - Ø 1/4" X 1"</b>	<b>8</b>
<b>C</b>		<b>ASSEMBLING BOLT - Ø 1/4" X 1 3/8"</b>  <b>BOULON D'ASSEMBLAGE - Ø 1/4" X 1 3/8"</b>	<b>20</b>
<b>D</b>		<b>ASSEMBLING BOLT - Ø 1/4" X 2"</b>  <b>BOULON D'ASSEMBLAGE - Ø 1/4" X 2"</b>	<b>6</b>
<b>E</b>		<b>ASSEMBLING BOLT - Ø 1/4" X 2 3/4"</b>  <b>BOULON D'ASSEMBLAGE - Ø 1/4" X 2 3/4"</b>	<b>2</b>

**LISTE DES PIÈCES DE MONTAGE**  
**HARDWARE LIST**

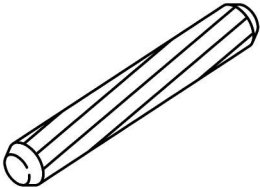
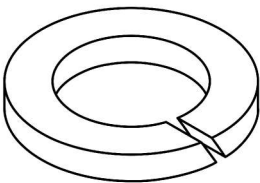
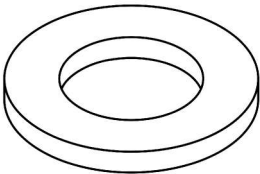
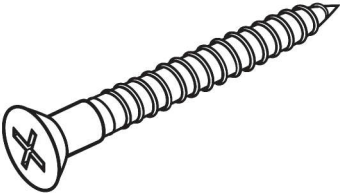
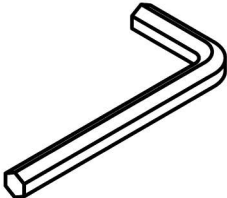
PIÈCE / PART #	IMAGE	DESCRIPTION	QTY / QTÉ
F		WOOD DOWEL GOUJON DE BOIS	2
G		LOCK WASHER ENTRETOISE DE MÉTAL	30
H		METAL WASHER RONDELLE DE MÉTAL	30
I		ASSEMBLING SCREW - Ø 1/8" X 1 1/4" VIS D'ASSEMBLAGE - Ø 1/8" X 1 1/4"	8
J		HEX KEY - M5, 4M CLÉ HEXAGONALE - M5, 4M	1

**LISTE DES PIÈCES DE MONTAGE**  
**HARDWARE LIST**

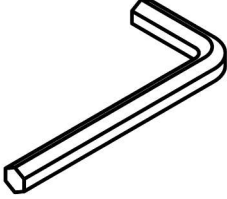
PIÈCE / PART #	IMAGE	DESCRIPTION	QTY / QTÉ
K		HEX KEY - M4 , 3M CLÉ HEXAGONALE - M4 , 3M	1

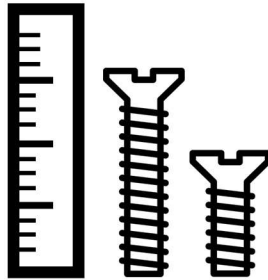

OUTIL DE VÉRIFICATION DE DIMENSIONS DES PIÈCES  
HARDWARE DIMENSIONS VERIFICATION TOOL

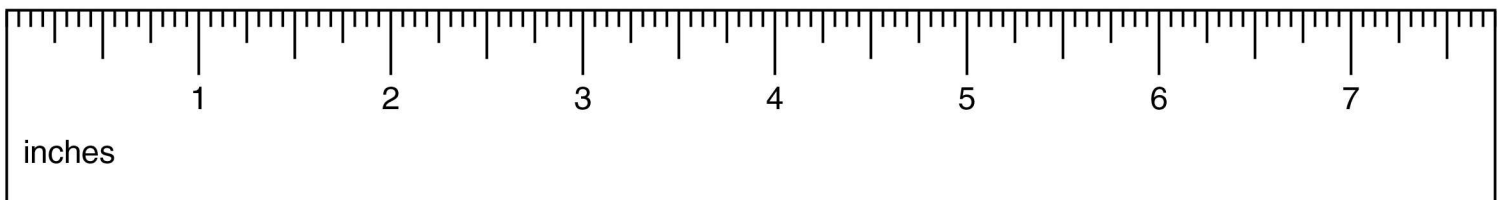



**ÉTAPE / STEP 1**

La quincaillerie et les composants sont situés dans l'unité de la tête de lit.

Hardware and components are located in the headboard unit.

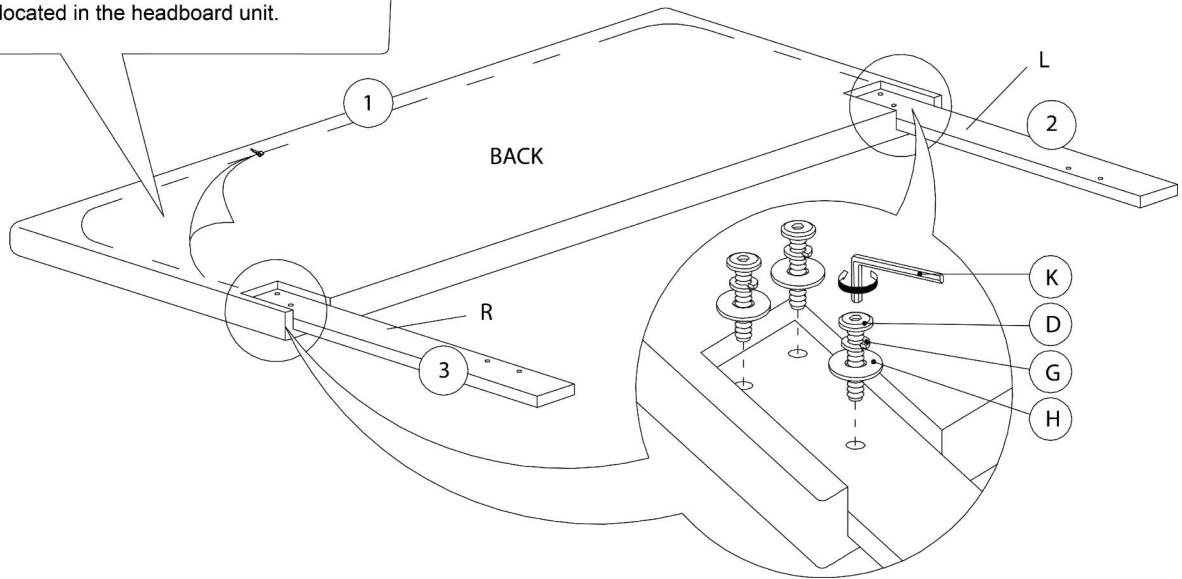

**ÉTAPE / STEP 2**

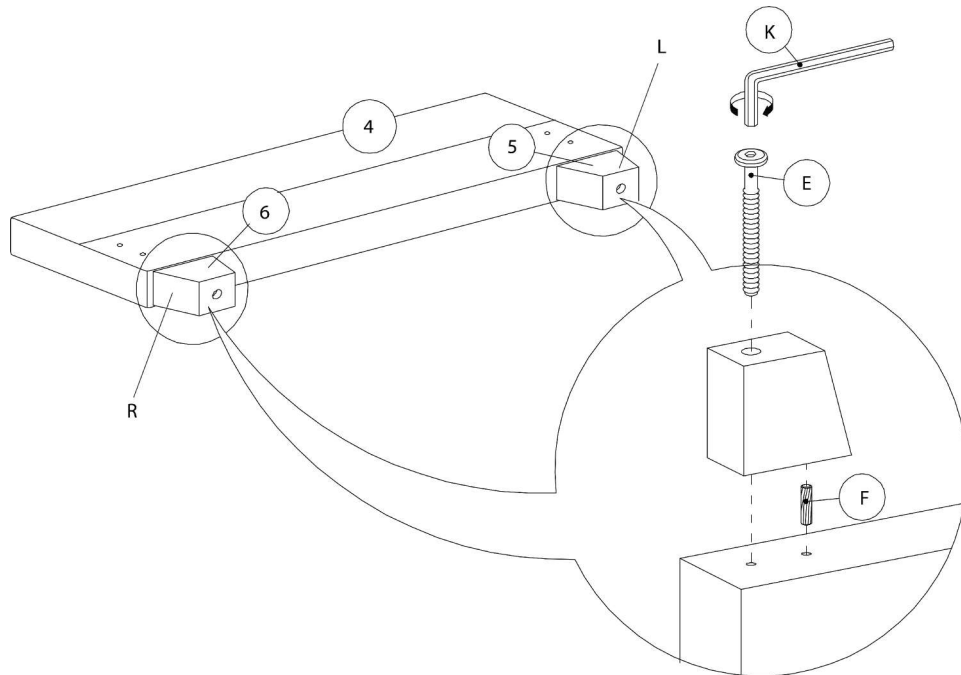

ÉTAPE / STEP 3

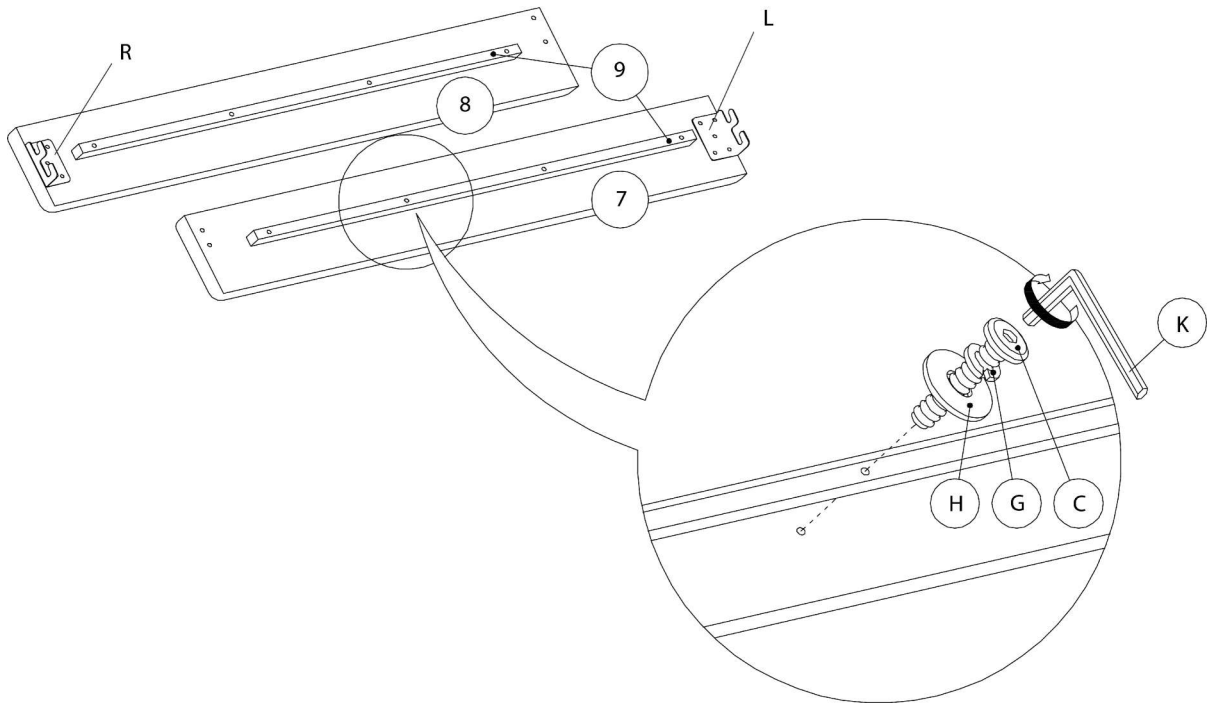

ÉTAPE / STEP 4

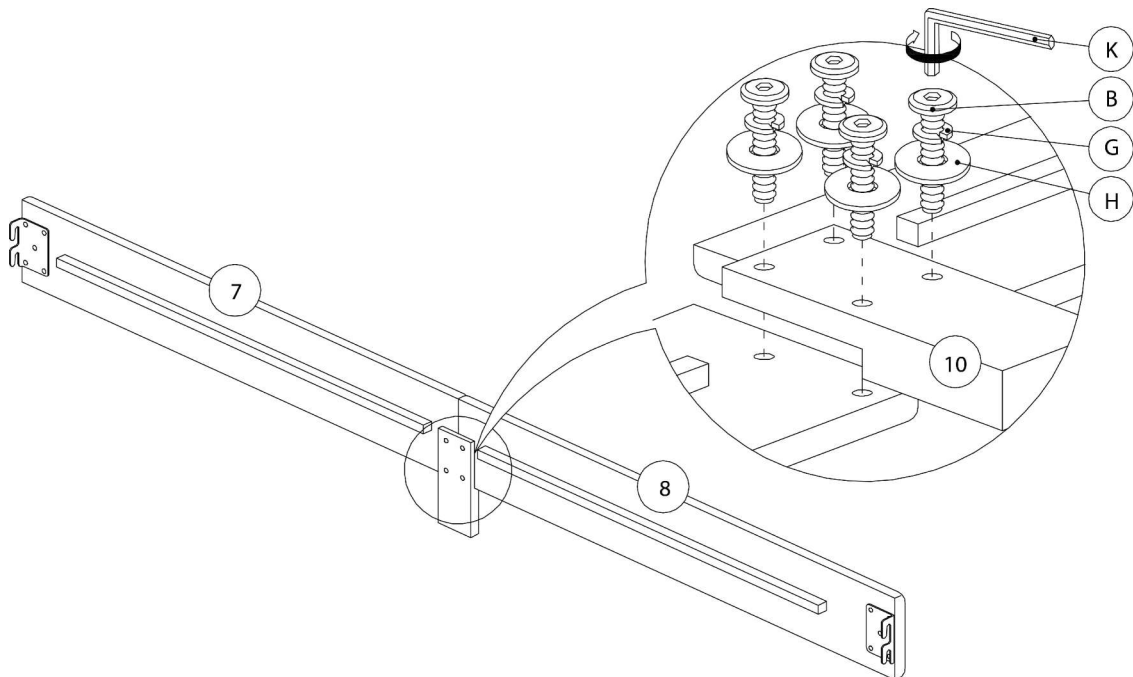

ÉTAPE / STEP 5

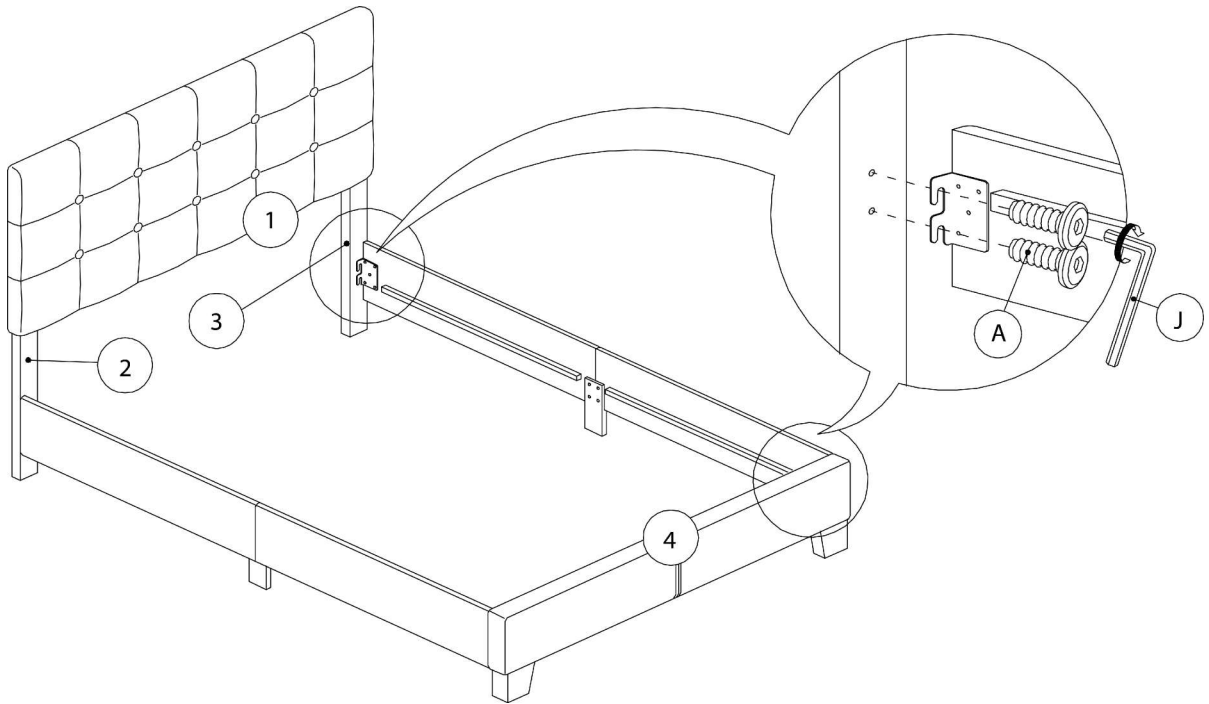

ÉTAPE / STEP 6

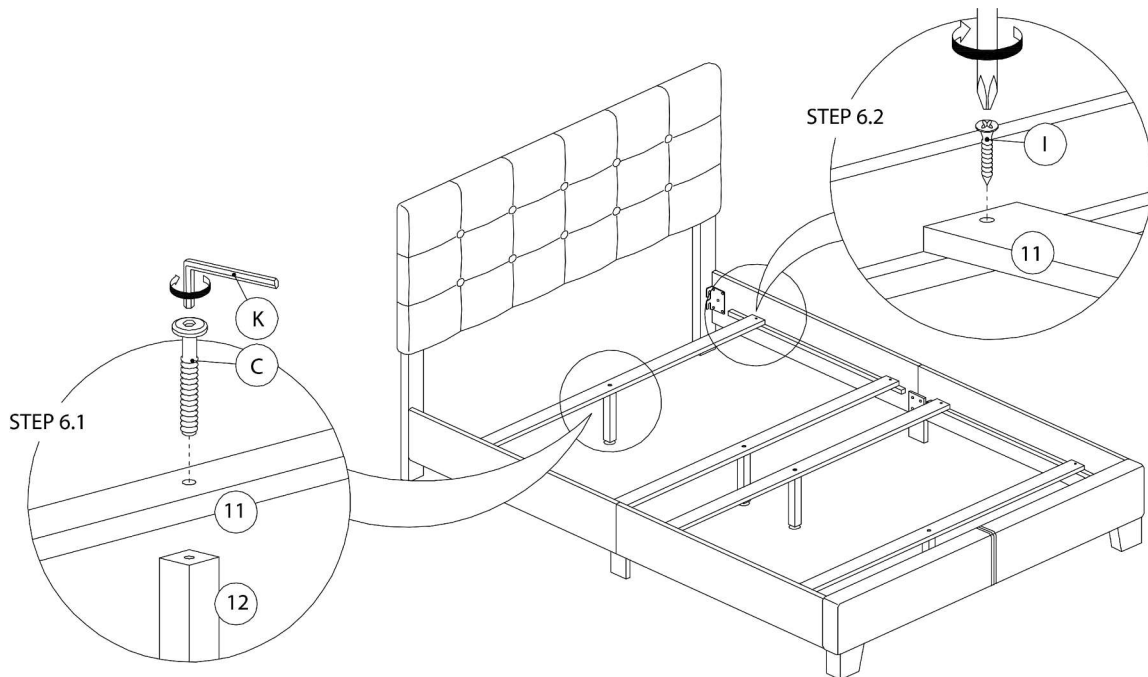

ÉTAPE / STEP 7

