

## User Manual

---

LSX

---

# Table of Contents

<b>1. Introduction</b>	<b>4</b>
<b>2. General Information</b>	<b>5</b>
2.1 Reading and Storing the User Manual	5
2.2 Signal symbol/word definitions	5
<b>3. Safety</b>	<b>6</b>
3.1 Proper Use	6
3.2 Safety Instructions	6
3.2.1 Notes on Electrical Safety	6
3.2.2 Battery Notes	7
3.2.3 General Safety Notes	8
3.2.4 Electromagnetic Interference	9
3.2.5 FCC Statement	9
3.2.6 FCC Radiation Exposure Statement	10
3.2.7 IC Statement	10
3.2.8 IC Radiation Exposure Statement	10
<b>4. In the Box and Unpacking</b>	<b>11</b>
<b>5. Controls and Connections</b>	<b>12</b>
5.1 Front Panel	12
5.2 Back Panel	13
5.3 Remote Control	14
<b>6. Status Indication (LED indicator)</b>	<b>15</b>
<b>7. Setting Up the LSX</b>	<b>16</b>
7.1 Installing the Speakers	16
7.2 Speaker Placement	16
7.3 Installing the KEF Apps	17
7.4 Setting Up with Wi-Fi	17
7.4.1 Internet Network Requirements	17
7.4.2 Android and iOS (Non Airplay 2) Method	18
7.4.3 iOS (Airplay 2) Method	20
7.5 Over the Air Firmware Update	21
7.5.1 Automatic Update Alert	21
7.5.2 Checking for Update Manually	22
7.6 Setting Up Without Wi-Fi	23
<b>8. Control Interface</b>	<b>24</b>
8.1 Using KEF Control App	24
8.1.1 Home Screen	24
8.1.2 Sound Optimization: EQ Settings	25
8.1.3 Adjusting the Settings of the Speakers	31
8.2 Using the Remote Control	35
8.2.1 Replacing the Battery	35
<b>9. Playback and Streaming</b>	<b>36</b>
9.1 Playback with Wi-Fi	36
9.1.1 Using the KEF Stream App	36
9.1.1.1 Home Screen	36
9.1.1.2 Main Menu	37
9.1.1.3 Playback Screen	38

9.1.1.4	Playing Music from Connected Device (Library).....	39
9.1.1.5	Playing Music from Media Servers.....	39
9.1.1.6	Playing Music from TIDAL.....	39
9.1.1.7	Playing Music from Spotify.....	40
9.1.1.8	Favourites.....	40
9.1.1.9	Recent.....	40
9.1.1.10	Queue.....	41
9.1.1.11	Playlists.....	43
9.1.1.12	Settings.....	46
9.1.2	Streaming with AirPlay 2.....	47
9.1.3	Streaming with Spotify Connect.....	48
9.1.4	Streaming with Qplay.....	49
9.1.5	Streaming with Roon.....	50
9.1.6	Streaming with DLNA.....	50
9.2	Playback with Bluetooth.....	51
9.2.1	Selecting Bluetooth Mode.....	51
9.2.2	Bluetooth Pairing.....	51
9.2.3	Playback Controls.....	51
9.3	Playback with Optical Input.....	52
9.3.1	Optical Cable Connection.....	52
9.3.2	Selecting Optical Mode.....	52
9.4	Playback with Auxiliary Input.....	52
9.4.1	Auxiliary Cable Connection.....	52
9.4.2	Selecting Auxiliary Mode.....	52
<b>10.</b>	<b>Cleaning and Maintenance .....</b>	<b>53</b>
<b>11.</b>	<b>Storage.....</b>	<b>53</b>
<b>12.</b>	<b>FAQ and Troubleshooting .....</b>	<b>54</b>
12.1	Setup and Network Connection.....	54
12.2	Operation.....	58
12.3	KEF Control App and KEF Stream App.....	61
12.4	Maintenance.....	62
12.5	Comments and Requests.....	63
12.6	Troubleshooting.....	63
12.7	Resetting to Factory Default.....	66
12.8	LED Indicators.....	67
<b>13.</b>	<b>Specifications.....</b>	<b>70</b>
<b>14.</b>	<b>Disposal .....</b>	<b>72</b>
14.1	Disposing of the Packaging.....	72
14.2	Disposing of the Speakers.....	72
14.3	Disposing of the Battery.....	72
<b>15.</b>	<b>Appendix.....</b>	<b>73</b>
15.1	Explanation of symbols.....	73
15.1.1	Warning Symbols.....	73
15.1.2	Regional Symbols.....	73
15.2	Integration with Home Automation Control System.....	75
15.3	IR Command Codes.....	76

# 1. Introduction

Thank you for choosing KEF wireless high-resolution speaker system – LSX.

Innovation is what sets KEF apart from its competitors. For over 50 years KEF has been at the forefront of loudspeaker research and development, designing class-leading speakers that have dealt with the challenges of reproducing the latest musical formats, and reproducing them to the highest possible quality. This legacy continues today with the LSX, our compact, yet powerful speaker system for the digital music era.

Please read and follow this user manual carefully before using the speaker system.

## 2. General Information

### 2.1 Reading and Storing the User Manual



This user manual accompanies the LSX speaker system (hereafter referred to as the “speakers”), and contains important information on setup and handling.

Before using your speakers, read the user manual carefully. This particularly applies to the safety instructions. Failure to do so may result in personal injury or damage to the speakers.

Retain the user manual for further use. Make sure to include this user manual when passing the speakers on to third parties.

### 2.2 Signal symbol/word definitions

The following symbols and signal words are used in this user manual.



This signal symbol/word designates a hazard with moderate risk, which may result in death or severe injury if not avoided.



This signal word warns of possible damage to property.



This signal word provides you with useful additional information on handling and use.

---

# 3. Safety

## 3.1 Proper Use

The speakers are exclusively intended for private indoor use and are not suitable for commercial purposes.

Use the speakers only as described in this user manual. Any other use is deemed improper and may result in damage to property or even personal injury. The speakers are not a toy.

The manufacturer or vendor accepts no liability for damage caused by improper or incorrect use.

## 3.2 Safety Instructions

### 3.2.1 Notes on Electrical Safety



#### **⚠ WARNING!**

#### **Risk of electric shock!**

Improper handling of the speakers may result in electric shock.

- **WARNING: TO REDUCE THE RISK OF FIRE OR ELECTRICAL SHOCK, DO NOT EXPOSE THIS APPLIANCE TO RAIN OR MOISTURE.**
- **CAUTION: TO REDUCE THE RISK OF ELECTRIC SHOCK, DO NOT REMOVE COVER (OR BACK). NO USER-SERVICEABLE PARTS INSIDE. REFER SERVICING TO QUALIFIED SERVICE PERSONNEL.**
- A combined power input lead and country specific power plug is provided.
- Check before connecting to your local power supply that the local supply voltage is the same as that marked on the underside of the device. If it is not, check with your supplier before proceeding.
- The device should be connected to a power socket/outlet with a protective earthing connection.
- Refer to the information on the underside of the enclosure for electrical and safety information before installing or operating the speakers.
- Only connect the speakers to an easily accessible socket/outlet so that you can quickly disconnect them from the power supply in the event of a problem.

- Do not use the speakers if they are damaged or if the power cable or plug is defective.
- Never touch the power plug with wet or damp hands.
- Do not pull the power plug out of the socket/outlet by the cable; instead, always pull it out by the plug itself.
- Never move, pull, or carry the speakers by their power cables.
- Lay the power cables so that they do not pose a tripping hazard.
- Do not kink the power cables and do not lay them over sharp edges.
- Only use the speakers indoors. Do not use the speakers in damp rooms or in the rain.

### 3.2.2 Battery Notes



DANGER if swallowed

#### **⚠ WARNING!**

#### **Risk of explosion, injury and damage!**

Improper handling of the battery increases the risk of explosion, leakage, serious injury and property damage.

- The remote control supplied with this product contains a coin/button cell battery. If the coin/button cell battery is swallowed, it can cause severe internal burns in just 2 hours and can lead to death.
- Danger of explosion if the battery is incorrectly replaced. Replace only with the same or equivalent type.
- Do not ingest the battery. Chemical burn hazard!
- Keep new and used batteries away from children.
- If the battery compartment does not close securely, stop using the remote control and keep it away from children.
- If you think batteries might have been swallowed or placed inside any part of the body, seek immediate medical attention.
- Dispose of used battery immediately.
- Battery must not be exposed to excessive heat such as direct sunlight, fire or the like.

### 3.2.3 General Safety Notes

#### WARNING!

##### Risk of injury and damage!

Improper handling of the speakers may increase the risk of injury and damage.

- Read these instructions.
- Keep these instructions - for future reference.
- Heed all warnings - on the speakers and in all product documentation.
- Follow all instructions.
- Do not use the speakers near water.
- The speakers shall not be exposed to dripping or splashing and no objects filled with liquids such as vases, shall be placed on the speakers.
- Clean only with dry cloth.
- Do not block any ventilation openings. Install in accordance with the manufacturer's instructions. To ensure reliable operation of the speakers and to protect them from overheating put the speakers in a position and location that will not interfere with their proper ventilation.
- Do not install near any heat sources such as radiators, heat registers, stoves, or other apparatus (including amplifiers) that produce heat.
- Avoid damp, temperature extremes and direct sunlight.
- Trailing cables are dangerous, secure all cables.
- No naked flame sources, such as lighted candles, should be placed on the speakers.
- (For specific markets only) Do not defeat the safety purpose of the polarized or grounding-type plug. A polarized plug has two blades with one wider than the other. A grounding-type plug has two blades and a third grounding prong. The wide blade or the third prong are provided for your safety. If the provided plug does not fit into your outlet, consult an electrician for replacement of the obsolete outlet.
- Protect the power cables from being walked on or pinched particularly at plugs, convenience receptacles, and the point where they exit from the speakers.
- The power plugs or the appliance coupler shall be readily accessible to completely disconnect the speakers from power.
- Only use attachments/accessories specified by the manufacturer.





- Use only with the cart, stand, tripod, bracket, or table specified by the manufacturer, or sold with the speakers. When a cart is used, use caution when moving the cart/speakers combination to avoid injury from tip-over.
- Unplug the speakers during lightning storms or when unused for long periods of time to prevent damage to these speakers.
- Refer all servicing to qualified service personnel. Servicing is required when the speakers have been damaged in any way, such as power cables or plugs are damaged, liquid has been spilled or objects have fallen into the speakers, the speakers have been exposed to rain or moisture, do not operate normally, or have been dropped. Do not attempt to service this product yourself. Opening or removing covers may expose you to dangerous voltages or other hazards. Please contact KEF to be referred to an authorized service center near you.

### 3.2.4 Electromagnetic Interference

The normal function of the product may be disturbed by strong electromagnetic interference. If so, simply reset the product to resume normal operation by following the user manual. In case the function could not resume, please use the product in other location.

### 3.2.5 FCC Statement

This equipment has been tested and found to comply with the limits for a Class B digital device, pursuant to Part 15 of the FCC Rules. These limits are designed to provide reasonable protection against harmful interference in a residential installation. This equipment generates, uses and can radiate radio frequency energy and, if not installed and used in accordance with the instructions, may cause harmful interference to radio communications. However, there is no guarantee that interference will not occur in a particular installation. If this equipment does cause harmful interference to radio or television reception, which can be determined by turning the equipment off and on, the user is encouraged to try to correct the interference by one of the following measures:

- Reorient or relocate the receiving antenna.
- Increase the separation between the equipment and receiver.
- Connect the equipment into an outlet on a circuit different from that to which the receiver is connected.
- Consult the dealer or an experienced radio/TV technician for help.

This device complies with Part 15 of the FCC Rules. Operation is subject to the following two conditions:

1. This device may not cause harmful interference, and
2. This device must accept any interference received, including interference that may cause undesired operation.

### 3.2.6 FCC Radiation Exposure Statement

This device complies with FCC radiation exposure limits set forth for an uncontrolled environment and it also complies with Part 15 of the FCC RF Rules. This equipment must be installed and operated in accordance with provided instructions and the antenna(s) used for this transmitter must be installed to provide a separation distance of at least 20 cm from all persons and must not be co-located or operating in conjunction with any other antenna or transmitter. End-users and installers must be provided with antenna installation instructions and consider removing the no-collocation statement.

The device meets the exemption from the routine evaluation limits in section 2.5 of RSS 102 and compliance with RSS-102 RF exposure, users can obtain Canadian information on RF exposure and compliance.

The device for operation in the band 5150-5250 MHz is only for indoor use to reduce the potential harmful interference to co-channel mobile satellite systems.

For devices with detachable antenna(s), the maximum antenna gain permitted for devices in the band 5725-5850 MHz shall be such that the equipment still complies with the e.i.r.p. limits specified for point-to-point and non-point-to-point operation as appropriate.

**CAUTION!** Any changes or modifications not expressly approved by the party responsible for compliance could void the user's authority to operate the equipment.

### 3.2.7 IC Statement

This device complies with Industry Canada's licence-exempt RSSs. Operation is subject to the following two conditions:

1. This device may not cause interference; and
2. This device must accept any interference, including interference that may cause undesired operation of the device.

This transmitter must not be co-located or operating in conjunction with any other antenna or transmitter. This equipment should be installed and operated with a minimum distance of 20 centimeters between the radiator and your body.

### 3.2.8 IC Radiation Exposure Statement

This equipment complies with IC RSS-102 radiation exposure limits set forth for an uncontrolled environment. This equipment should be installed and operated with a minimum distance of 20 cm between the radiator and any part of your body.

# 4. In the Box and Unpacking

## NOTICE!

### Risk of damage!

Using a sharp knife or other pointed object to open the packaging may damage the speakers.

- Be very careful when opening the packaging. Follow the instructions on the packaging to lift up the speakers from the sides to avoid damaging the Uni-Q drivers (speaker cones).

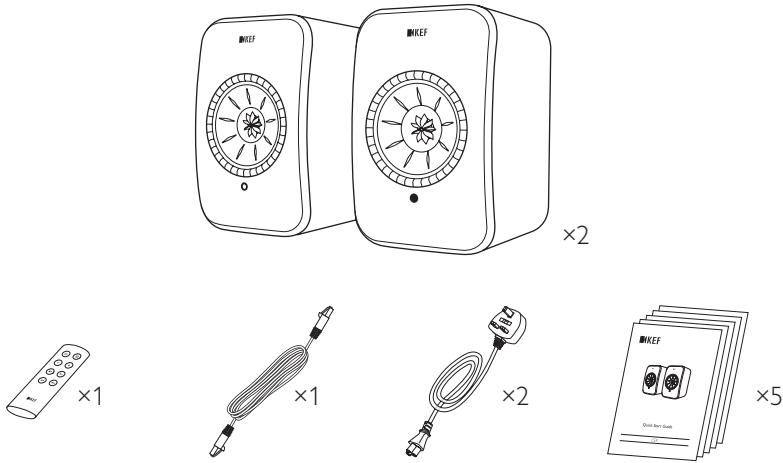

1. Take the speakers out of the packaging.
2. Check to make sure that all parts are included, including:
  - Speaker  $\times 2$  (Master Speaker  $\times 1$ , Slave Speaker  $\times 1$ )
  - Remote control\*  $\times 1$
  - Inter-speaker cable  $\times 1$  (length: 3 m)
  - Power cable  $\times 2$  (length: 2 m, with country-specific power plugs)
  - Printed materials: Quick start guide, important safety information, specifications, warranty information, and maintenance guide for Kvadrat fabrics
3. Check whether the speakers or individual parts are damaged. If this is the case, do not use the speakers. Contact your retailer via the contact information indicated on the warranty information.

\*Remove the insulation tab from the battery compartment before use.

## 5. Controls and Connections

### 5.1 Front Panel

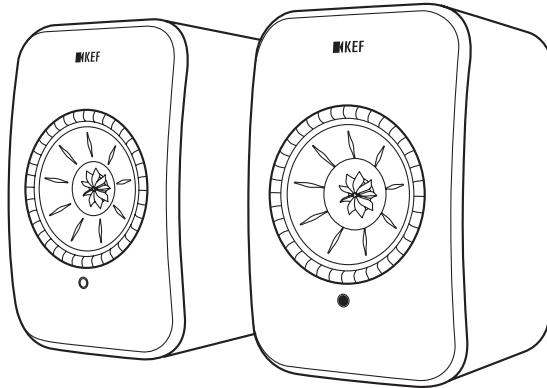

Slave Speaker

Master Speaker

- An LED indicator can be found on each speaker, below the Uni-Q driver (speaker cone).
- The IR (infrared) receiver for the remote control can be found on the Master Speaker where the LED indicator is located.



The LED indicator of the Slave Speaker only comes on when:

- The Slave Speaker is initially connected to power and is working properly. The LED indicator will briefly come on orange and then go out.
- An error occurs.

During normal operation the LED indicator on the Slave Speaker will not illuminate.

## 5.2 Back Panel

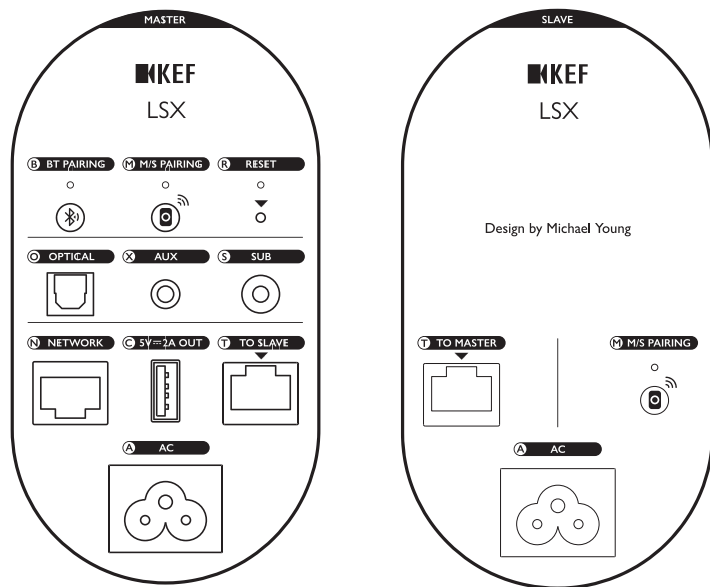

Controls and connections are found on the back panel of each speaker, marked as shown.

<b>B</b>	Bluetooth pairing button	Enables Bluetooth pairing. The speakers will be ready to pair a new device. Any Bluetooth connected device will be disconnected.
<b>M</b>	Master-Slave pairing button	Re-establishes the connection between the Master and Slave Speakers if the connection is lost.
<b>R</b>	Factory reset button (inside the small hole)	<u>Resets</u> the speakers to the factory defaults.
<b>O</b>	Optical input port	Plays audio input from a source (e.g. television*, game console) through an optical cable (not provided).
<b>X</b>	Auxiliary input jack	Plays audio input from a source (e.g. phono stage) through a 3.5 mm audio cable (not provided).
<b>S</b>	Subwoofer output jack	Connects a subwoofer with the speakers through an RCA cable (not provided).
<b>N</b>	Network port	Connects the speakers to a router with a LAN cable (not provided).

<b>C</b>	USB power port (5 V $\overline{\text{---}}$ 2 A)	Charges Compatible Personal Assistant Devices and mobile devices. Charging is not available when the speakers are in Standby Mode.
<b>T</b>	To Master/Slave connection port	Connects to the Master/Slave Speaker with the inter-speaker cable.
<b>A</b>	AC input connector	Connects the speakers to the power source with the power cables.

\*Make sure your television is set to output digital audio in PCM format. Refer to the user manual of your television for details.

**i** A threaded hole (1/4–20 UNC) can be found on the underside of each speaker for stands or wall mounting. See chapter “[Installing the Speakers](#)”.

## 5.3 Remote Control

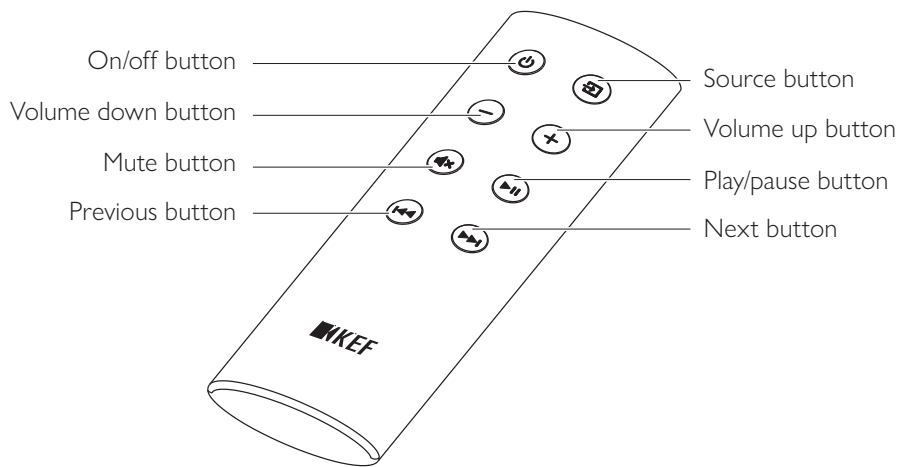





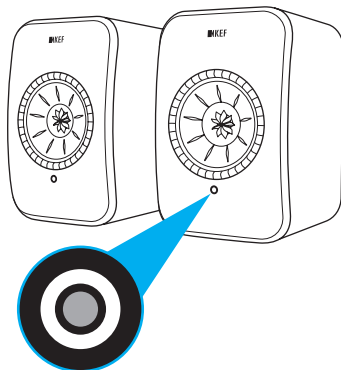

**i** Remove the insulation tab from the battery compartment before use.

## 6. Status Indication (LED indicator)

The connection and operation status can be easily checked through the colours and patterns of the LED indicator on the Master Speaker.



Pattern	Status
 Alternating between white and orange	The speakers are ready to connect to a Wi-Fi network. Launch the KEF Control app to set up the speakers.
 Solid orange	The speakers are in Standby Mode and connected to a Wi-Fi network.
 Solid white	The speakers are operating in Wi-Fi Mode.
 Solid green	The speakers are operating in Spotify Connect Mode.
 Solid blue	The speakers are operating in Bluetooth Mode and a device is already paired with the speakers.
 Solid purple	The speakers are operating in Optical Mode.
 Solid yellow	The speakers are operating in AUX Mode.



For a full list of colours and patterns, see chapter “[LED Indicators](#)”.

## 7. Setting Up the LSX

### 7.1 Installing the Speakers

- The speakers should be placed on a flat and level surface that is free from vibration.
- The speakers can be mounted on stands or on the wall. A threaded hole (1/4–20 UNC) can be found on the underside of each speaker.

**WARNING:** Be aware of the potential hazards from tipping or knocking the speakers off the stands which may result in personal injury, or property damage.

### 7.2 Speaker Placement

The two speakers are distinguished between the Master and Slave Speakers. By default, the Master Speaker is the right channel\* and should be placed on your right hand side as you face the speakers. For the best stereo experience or soundstage, place the speakers around 1 to 3 meters apart.

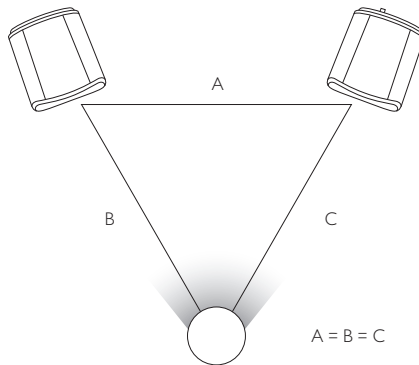

The optimum distance between the speakers and the listener will depend on how far the Master and Slave Speakers are separated. Try to keep the same distance to the listener to form an equilateral triangle.

\*The left and right channels can be swapped through the KEF Control app. See chapter "[Inverse L/R Speakers](#)".



#### Maximum Distance between the Two Speakers

Wireless Mode	Up to 5 meters. Note that RF interference, including Wi-Fi and Bluetooth may reduce this distance.
Cable Mode	Connect with a shielded Cat-6 Ethernet cable. The maximum cable length is 8 metres.



## 7.3 Installing the KEF Apps

For comprehensive control and to enjoy streaming music, install the KEF Control app and KEF Stream app on your iOS\* or Android\*\* devices. Search “KEF Control” and “KEF Stream” in the App Store or Google Play Store to download and install the apps.



The KEF Control app allows you to set up the speakers, apply sound settings, turn on/off the speakers and switch sound sources.

The KEF Stream app allows you to access to and play back your locally or network stored music.

\*Requires iOS 10 or above. \*\*Requires Android 4.4 or above.

## 7.4 Setting Up with Wi-Fi

For the best sound quality, comprehensive control and full functionality, the speakers should be “onboarded” to your personal Wi-Fi network.

### 7.4.1 Internet Network Requirements

For better streaming stability, especially for hi-res music streaming, a 5 GHz Wi-Fi network with a router transmission speed of at least 1,300 Mbps is recommended.

#### • Technical Requirements

Support IEEE 802.11a/b/g/n

Using security protocol WPA2



- Open networks are not recommended for security reasons.
- WEP is an old encryption method and may lead to setup and streaming problems.
- Refer to the user manual of your router to select the encryption method.



**Connecting to an office network:** The speakers are designed to work with a personal Wi-Fi network. In office networks, additional security or authentication methods are commonly introduced which may prevent the speakers from connecting. You may need the help of the network administrator to configure the network if the speakers are to be connected to an office network.

## 7.4.2 Android and iOS (Non Airplay 2) Method

**i** Airplay 2 is available from firmware version 4.0. After firmware upgrade, iOS users should follow the chapter "iOS (Airplay 2) Method" to perform the setup.

1. To connect LSX to your network, open the KEF Control app on your device. Select "KEF LSX" from the selection menu and then tap "Next".
2. Connect the power cables to the AC input connectors at the back of the speakers. Then tap "Next".
3. The LED indicator on the Master Speaker will flash orange and white, indicating that the speakers are ready for connection. Tap "Next".

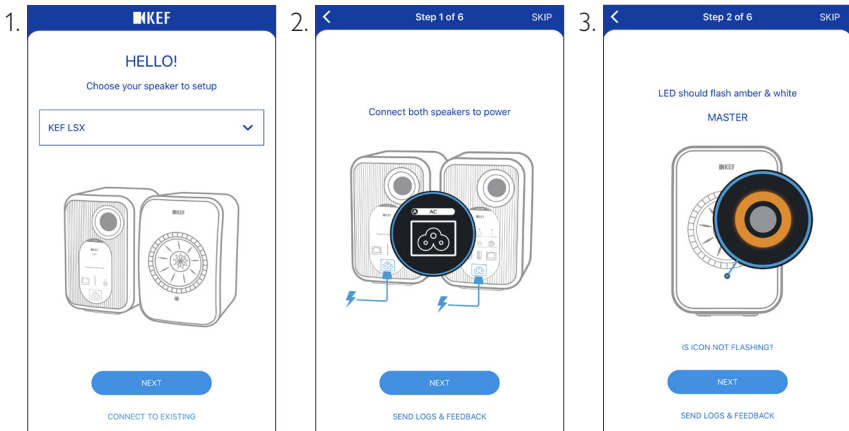

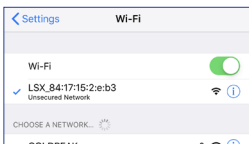

4. Tap the Home button of your device.
5. Open the "Settings" app of your device.
6. Select "Wi-Fi".
7. Select "LSX\_XXX" from the available networks.

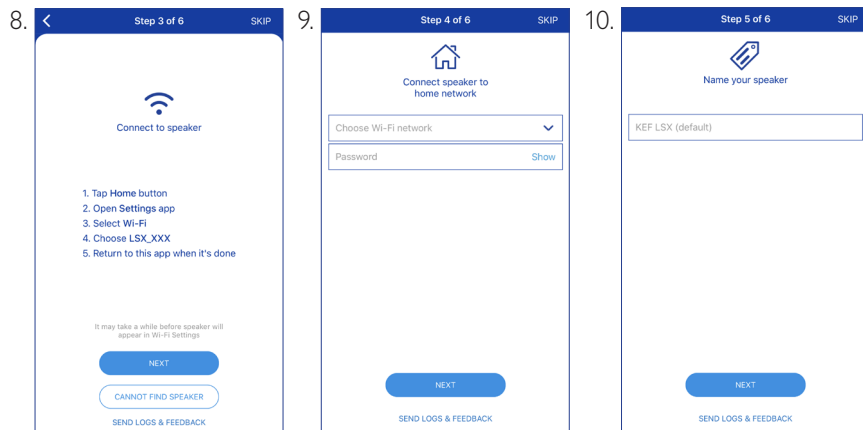

8. Return to the KEF Control app and then tap “Next”.
9. Select your Wi-Fi network from the list, enter the password of your Wi-Fi network and then tap “Next”.
10. Create a name for the speakers (optional) and then tap “Next”.

The onboarding process will be automatically completed. The LED indicator on the Master Speaker will light solid white when the connection is successful. The Slave Speaker will be automatically and wirelessly connected to the Master Speaker.



 The above process is slightly different between iOS and Android devices. In this case, follow the instructions on the screen to complete the connection.

### 7.4.3 iOS (Airplay 2) Method

Once your speakers are upgraded with Airplay 2, iOS users can use this method to connect the speakers to your network.

1. To get the speakers connected to a network, connect the power cables to the AC input connectors at the back of the speakers. The LED indicator on the Master Speaker will flash orange and white.
2. Open the KEF Control app on your device. Select “KEF LSX Airplay” from the selection menu and then tap “Next”.

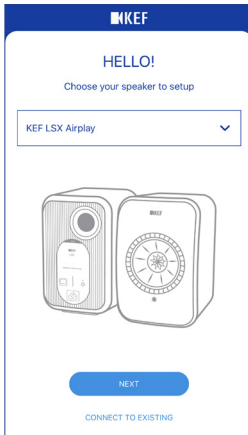

3. Select “LSX\_XXX” under “Set up new airplay speaker...”.



4. Select the network to join and then tap “Next”.



The onboarding process will be automatically completed. The LED indicator on the Master Speaker will light solid white when the connection is successful. The Slave Speaker will be automatically and wirelessly connected to the Master Speaker.

## 7.5 Over the Air Firmware Update

### 7.5.1 Automatic Update Alert

1. You will be reminded to update the firmware if a newer version is available. Tap “Update” to continue.
2. Connect the Master and Slave Speakers with the provided inter-speaker cable through the “To Master/Slave” connection ports on the back of the speakers and then tap “Next”. Cable Mode will also be automatically activated (see chapter “Cable Mode”).
3. Wait until the firmware is downloaded and updated.

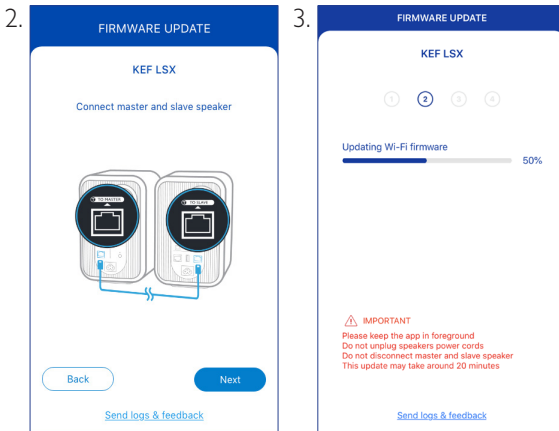

The entire process may take around 20 minutes. The KEF Control app must be **KEPT IN THE FOREGROUND**. **DO NOT** unplug the power cables, **DO NOT** disconnect the inter-speaker cable and **DO NOT** reset speakers during the upgrade.

## 7.5.2 Checking for Update Manually

1. To check whether a firmware update is available, launch the KEF Control app.
2. Tap the speaker settings icon (⋮) at the top right corner to access the settings menu.
3. Tap “Firmware Update”.
4. If a new firmware is available, tap “Update”.
5. Follow the instructions on the KEF Control app to complete the update (see chapter “Automatic Update Alert”).

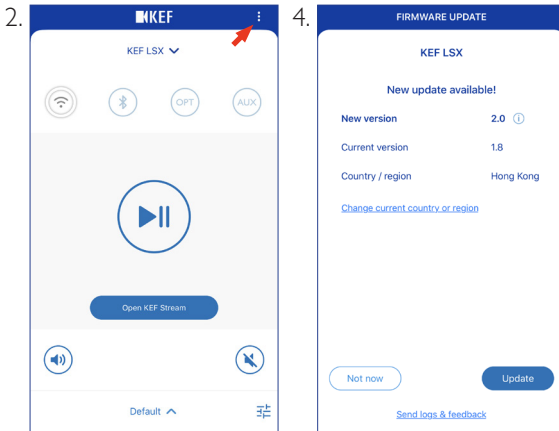

- When the firmware update is completed, you may disconnect the inter-speaker cable. Cable Mode will automatically be disabled if already done so before the update.
- If for any reason there is a failure during the firmware update process, you may recover your speakers through the Recovery Mode feature in the KEF Control app. See chapter “Recovery Mode”.

## 7.6 Setting Up Without Wi-Fi

You can still set up the speakers without a Wi-Fi network. However, this will limit the controls and functionality of the speakers. In addition, important updates and bug fixes will be missed without Wi-Fi connection.

1. To set up without Wi-Fi connection, connect the power cables to the AC input connectors at the back of the speakers. The LED indicator on the Master Speaker will flash orange and white.
2. Point the remote control toward the Master Speaker.
3. Press and hold the source button (  ) on the remote control for 5 seconds until the LED indicator on the Master Speaker flashes blue and orange. This indicates that Wi-Fi Mode is disabled.

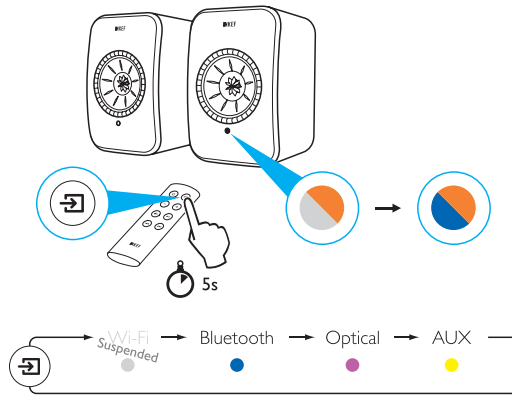

4. In this mode you will have access to Bluetooth, Optical and AUX Modes.



To resume using the speakers with a Wi-Fi connection, the speakers must be reset. See chapter "[Resetting to Factory Default](#)".

# 8. Control Interface

## 8.1 Using KEF Control App

The KEF Control app lets you set up the speakers, apply sound settings, turn the speakers on and off and switch sound sources.

### 8.1.1 Home Screen



Speaker selection	Selects a pair of speakers available for control through the KEF Control app. You can also add a new pair of compatible speakers by selecting “Add new speaker”.
Volume control	Tap once and then use the volume slider to adjust the volume.
Sound profile	Selects a sound profile created in the EQ settings menu.
Speaker settings	Accesses the speaker settings menu.
Source	Tap one of the source buttons (W-Fi, Bluetooth, Optical and AUX) to select a sound source, or to turn on or off the speakers to or from the selected source.
Play/pause	Plays or pauses the playback.
KEF Stream app	Prompts to the KEF Stream app.
Mute	Mutes or restores the sound output.
EQ settings	Accesses the sound settings menu.



## 8.1.2 Sound Optimization: EQ Settings

1. To adjust the sound settings of the speakers, tap the EQ settings icon (  ) at the lower right corner in the home screen.

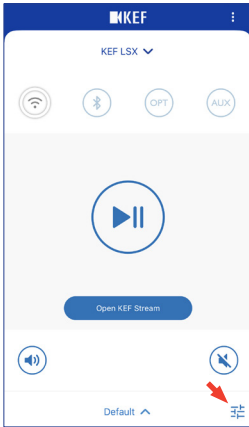

2. Then tap “Add New Profile” to proceed.

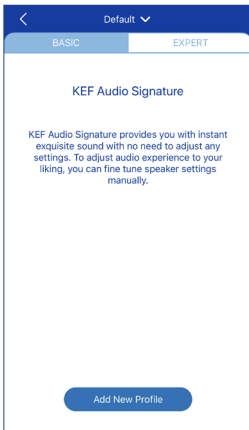

You can then select between Basic and Expert Modes. The sound adjustments you have configured in Basic or Expert Mode are the same.

## • Basic Mode

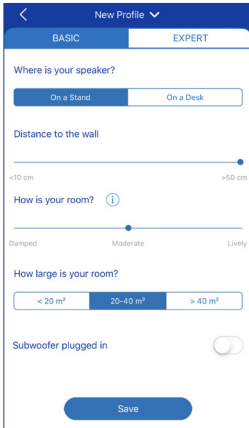

Basic Mode lets you configure the EQ settings according to your listening area. They include:

- Installation location: On a stand or on a desk
- Distance from front edge of the table (on a desk only) (> 50 cm to 0 cm)

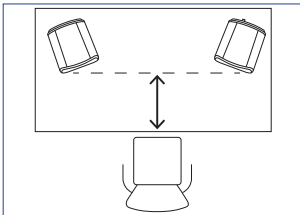

- Distance to the wall (< 10 cm to > 50 cm)

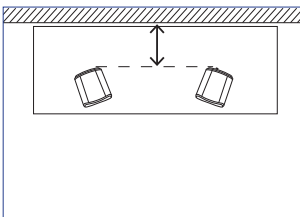

- How is your room? (Damped / Moderate / Lively)

Damped: Large furniture, thick carpet and heavy curtains

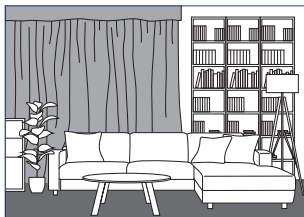

Moderate: Medium furniture, thinner carpet or rug, some curtains and features on walls

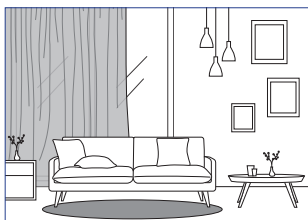

Lively: Hard floor, less furniture, large windows and no curtains



- How large is the room? ( $< 20 \text{ m}^2$  /  $20\text{--}40 \text{ m}^2$  /  $> 40 \text{ m}^2$ )
- A subwoofer is plugged in (On / Off).

If a subwoofer is plugged in, set up the subwoofer volume and speaker/subwoofer balance.

When the settings are done, tap “Save” at the bottom of the screen and create a name for saving your sound profile.

## • Expert Mode

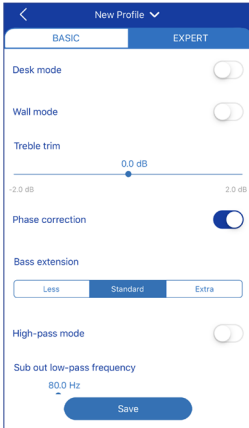

The Expert Mode lets you configure the EQ preferences in greater precision.

They include:

- Desk Mode (On / Off, -6.0 dB to 0.0 dB)
- Wall Mode (On / Off, -6.0 dB to 0.0 dB)
- Treble Trim (-2.0 dB to 2.0 dB)
- Phase Correction (On / Off)
- Bass Extension (Less / Standard / Extra)
- High-Pass Mode (On / Off, 50 Hz to 120 Hz)
- Sub Out Low-Pass Frequency (40 Hz to 250 Hz)
- Sub Gain (-10 dB to 10 dB)
- Sub Polarity (+ / -)

When the settings are done, tap “Save” at the bottom of the screen and create a name for saving your sound profile.



## Understanding the EQ Settings

### **On a desk/distance from front edge of the table (Expert Mode: Desk Mode):**

This setting adjusts the “presence” region (170 Hz +/- 1 octave). Too much causes a muddy sound, while a lack of presence makes the sound distant and empty.

**Distance to the wall (Expert Mode: Wall Mode):** This setting adjusts all frequencies from around 500 Hz downwards, causing broader changes than Desk Mode. A dip in these frequencies causes a tinny sound, while too much of these frequencies can overwhelm the overall presentation with lower frequencies.

**How is your room? (Expert Mode: Treble Trim):** This adjusts the frequencies above 500 Hz. A damped room can make sound seem muted, while a lively room can make it sound harsh. Move towards damped to reduce the muting effect, or move towards lively to tame harshness.

**How large is your room (Expert Mode: Bass Extension):** This setting adjusts the bass extension of the speakers. The larger the room selected, the lower the roll-off point is.



## Understanding the Subwoofer Settings

**Subwoofer/Speaker Balance (Basic Mode):** This controls the bass output between the subwoofer and the speakers. If the slider is moved more to “Subwoofer”, most of the bass output will be handled by the subwoofer.

**High-Pass Mode:** Frequencies above the set point will be played by the speakers.

**Sub Out Low-Pass Frequency:** Frequencies below the set point will be handled by the subwoofer. This can overlap with the high-pass frequency to help integrate the speaker/subwoofer more effectively with no dip or peak in overall response.

**Sub Gain:** This changes the signal level output to the subwoofer.

**Sub Polarity:** Ideally, the speakers and subwoofer should be moving in the same direction at the same time, otherwise frequencies can be cancelled out. Switching the polarity of the subwoofer can remedy a perceived lack of bass response.

## Selecting a Sound Profile

1. Tap the name of the current sound profile at the bottom of the home screen.

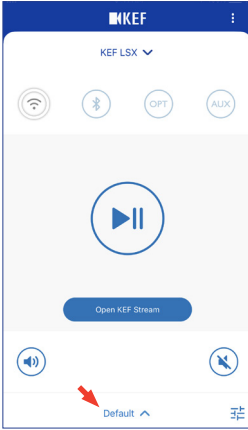

2. Select a sound profile from the selection menu.

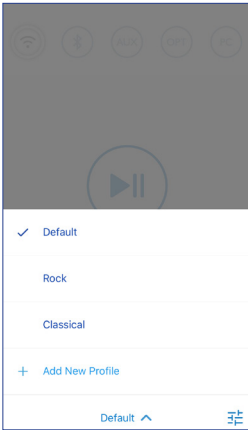

## 8.1.3 Adjusting the Settings of the Speakers

Tap the Speaker Settings icon (⋮) at the top right corner on the home screen to access the settings menu for more configurations.

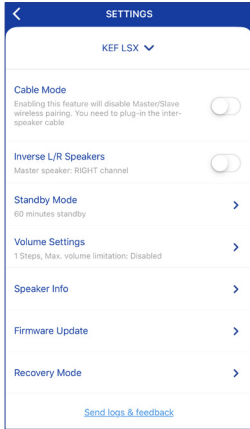

### • Cable Mode

You can connect the Master and Slave Speakers with the provided inter-speaker cable through the “To Master/Slave” connection ports on the back of the speakers.

Once the cable is connected, enable Cable Mode to disable the wireless connection.



Cable Mode is required/recommended when:

- You are performing a firmware update.
- You prefer a better resolution at 96 kHz/24 bit (wireless: 48 kHz/24 bit).
- You are experiencing audio dropouts due to interference.

### • Inverse L/R Speakers

Enable this setting to change the master channel to the left (L) channel.

### • Standby Mode

This determines how long (20 or 60 min) the speakers will remain idle before automatically entering Standby Mode. If “never” is selected, the speakers must be manually turned off.

- **Volume Settings**

This lets you configure the following:

- **Hardware Volume Buttons**

This feature is only available on iOS devices. The hardware volume buttons refer to the physical volume buttons on your device. Disable this feature when you are experiencing conflicts with other music streaming apps over Wi-Fi.

- **Volume Button Sensitivity**

This feature lets you configure the volume steps for each single press of the physical volume buttons of your device.

- **Enable Limitation**

This feature lets you set the maximum limit when adjusting the volume.

- **Speaker Info**

This lets you:

- Rename the speakers

- Find out:

MAC address

IP address

Speaker serial number

Firmware version

- Forget Speaker: To remove the speakers from KEF Control app.

- **Firmware Update**

This setting checks if a new firmware is available for update. See chapter "[Over the Air Firmware Update](#)".

- **Recovery Mode**

This mode recovers the speakers when there is a failure during the firmware update.

1. Make sure all other KEF wireless speakers, if any, are removed from the network (including LS50 Wireless speakers) and only keep the LSX speakers that require recovery on the network.
2. Disconnect the power cable from the Master Speaker.



3. Launch the KEF Control app. Go to “Recovery Mode” in “Settings”. Closely follow the instructions before tapping “Next”.
4. Connect the LAN cable from your router to the network port [N] of the Master Speaker. Then tap “Next”.
5. Connect the Master and Slave Speakers with the provided inter-speaker cable through the “To Master/Slave” connection ports on the back of the speakers. Then tap “Next”.

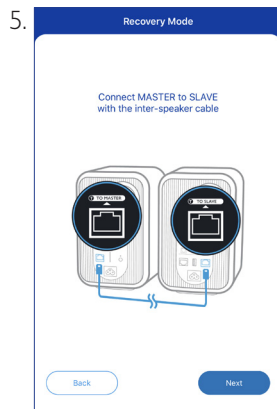
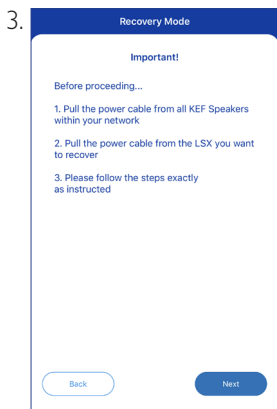

6. Using a paperclip/pin, press and hold the factory reset button [R] on the back of the Master Speaker.
7. Without releasing the factory reset button, connect the power cable to AC input connector [A] of the Master Speaker until the LED indicators at the front of the Master and Slave Speakers flash white, blue, purple and yellow. Then tap “Next”.
8. The KEF Control app will start searching for your speakers to resume the firmware update process.

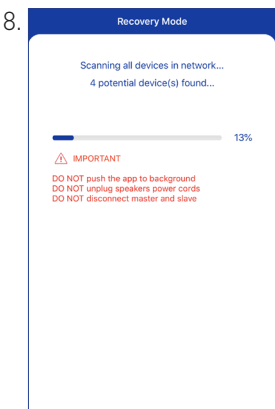
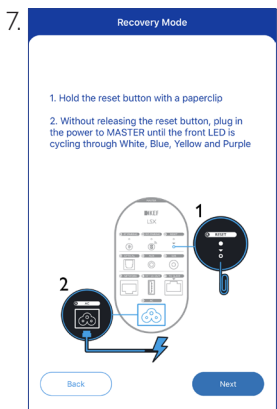



Depending on the nature of failure, you may see an alert with a “Start recovery” button in the KEF Control app during the firmware update. In this case, closely follow the instructions in the app to carry out the recovery.

- **Advanced Settings**

This lets you configure the following:

- **My Speakers**

This lets you register a new pair of speakers with the KEF Control app.

- **Analytics**

This allows the KEF Control app to send crash reports and improvement analytics to the manufacturer. We recommend to enable both items.

- **About**

This lets you:

- Find out the current version of the KEF Control app.
- Visit the KEF website.
- Register the product.
- Read the licenses agreement.
- Read the privacy policy.
- Read the FAQ for help and support.



Make use of the “Send logs and feedback” feature at the bottom of the settings menu if you experience problems or want to send us feedback or suggestions.

## 8.2 Using the Remote Control

The remote control lets you perform basic controls of the speakers.

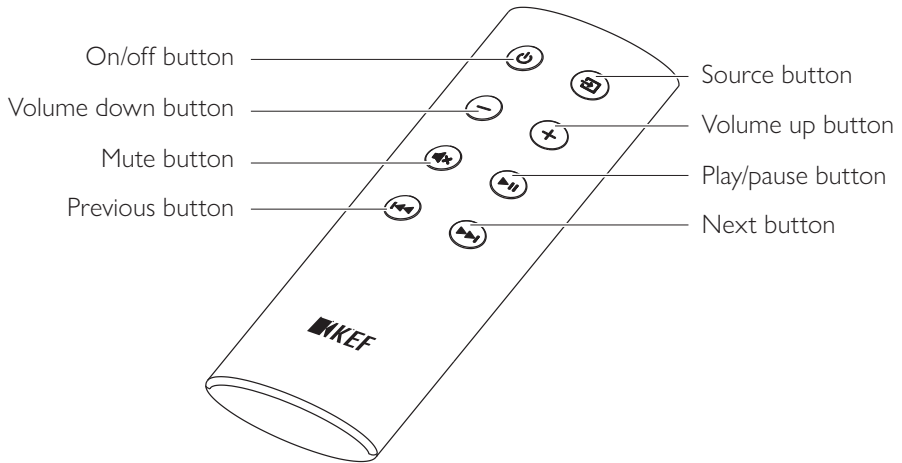

On/off button	Turns on or off the speakers.
Volume down button	Decreases the volume.
Mute button	Mutes or restores the sound output.
Previous button	Skips to the previous track.
Source button	Selects a sound source (Wi-Fi, Bluetooth, Optical and AUX).
Volume up button	Increases the volume.
Play/pause button	Plays or pauses the playback.
Next button	Skips to the next track.

### 8.2.1 Replacing the Battery

If the remote control is less responsive or not working, the battery power may be low. Replace the battery (CR2023, 3 V) with a new one.

1. Slide open the battery compartment door on the back.
2. Remove the old battery from the battery compartment.
3. Properly dispose of the old battery and keep it away from children and pets.
4. Insert the new battery. Make sure the positive (+) side is facing upward.
5. Replace the battery compartment door.

## 9. Playback and Streaming

### 9.1 Playback with Wi-Fi

#### 9.1.1 Using the KEF Stream App

The KEF Stream app allows you to access to and play back your locally or network stored music as well as music from streaming services (Spotify and Tidal).

##### 9.1.1.1 Home Screen

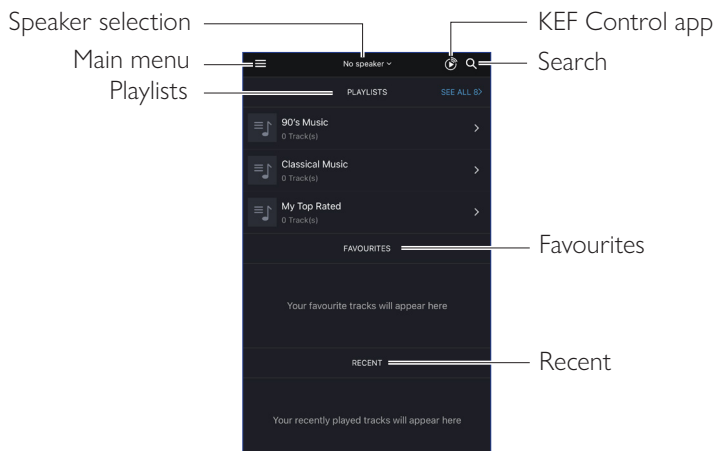

Speaker selection	Shows the list of speakers available for streaming through the KEF Stream app. You can also add a new pair of compatible speakers by selecting "Add new speaker".
Main menu	Accesses the main menu.
Playlists	Shows the playlists you have recently played.
KEF Control app	Prompts to the KEF Control app.
Search	Looks for a particular track from the local library.
Favourites	Shows the tracks you have added as favourites.
Recent	Shows the tracks you have recently played.

### 9.1.1.2 Main Menu

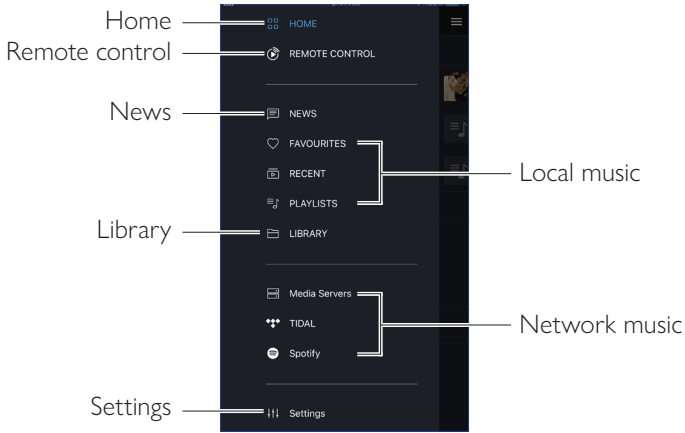

Home	Accesses Home Screen.
Remote control	Prompts to the KEF Control app.
News	Checks out the latest updates on new features, firmware update and other useful information.
Library	Accesses the local library. Displays compatible music files saved on device.
Settings	Accesses the settings menu.
Local music	Tap the corresponding option to show the favourites and playlists in the local library, and the recently played tracks from the local library.
Network music	Tap the corresponding option for playback from NAS drives or from compatible streaming services (TIDAL and Spotify) over the network.

### 9.1.1.3 Playback Screen

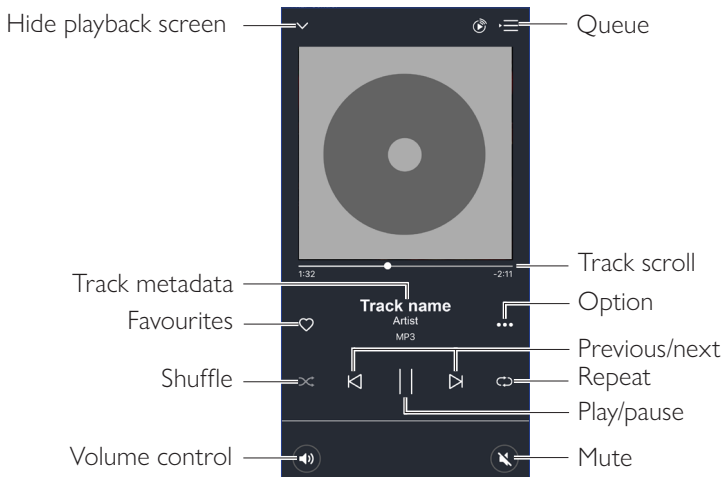

Hide playback screen	Hides the playback screen.
Track metadata	Shows the metadata (e.g. song name) of the track.
Favourites	Adds the track to favourites.
Shuffle	Activates/deactivates the random playback of tracks.
Volume control	Tap once and then use the volume slider to adjust the volume.
Queue	Accesses the queue.
Track scroll	Shows the playback progress. Drag the dot along the bar to skip to a particular point of the track.
Option	Adds/removes the track as favourites, adds the track to a playlist, or goes to the album/artist of the track.
Previous/next	Goes the previous or next track.
Repeat	Selects a repeat mode (repeat 1, repeat all) for playback.
Play/pause	Starts or pauses the playback.
Mute	Mutes or restores the sound output.

### 9.1.1.4 Playing Music from Connected Device (Library)

This lets you play compatible music files stored in the connected device (e.g. mobile phone).

1. Tap “Library” to show the music files stored in the device.



2. Browse and select a track to play.

Music files are categorized according to artists, tracks and album.

### 9.1.1.5 Playing Music from Media Servers

This lets you play compatible music files stored in the music library of a connected media server (e.g. NAS drive via DLAN/uPnP). The media server must be on the same network as the speakers.

1. Tap “Media Servers” from the main menu.

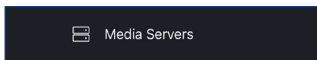

2. Tap the name of an available media server.
3. Browse and select a track to play.

### 9.1.1.6 Playing Music from TIDAL



TIDAL is a subscription-based music, podcast and video streaming service that combines lossless audio and high-definition music videos with exclusive content and special features on music. You can access your TIDAL account through the app to play high resolution audio. A valid Hi-Fi tier subscription is required.

1. Tap “TIDAL” from the main menu.



2. Login to your TIDAL account.

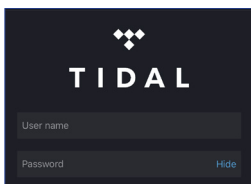

3. Browse and select a track to play.

### 9.1.1.7 Playing Music from Spotify

See chapter “[Streaming with Spotify Connect](#)”.

### 9.1.1.8 Favourites

To show the favourites in your local library, tap “Favourites” from the main menu. The recently added favorites can be found on the home screen.



- **Selecting or Deselecting a Track as Favourites**

From the playback screen, tap the heart icon (♥) to select or deselect the track as favorites, or

From a list of tracks, tap the option icon (⋮) on the right hand side and then select “Add to Favorites” or “Remove from Favourites”.

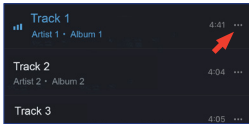

### 9.1.1.9 Recent

Tap “Recent” from the main menu to show the most recently played tracks from your local library. The most recently played tracks can also be found on the home screen.





### 9.1.1.10 Queue

Adding a track to the queue means the track will be played after the current playing track. The queue is not permanent and cannot be saved.

- **Adding a Track in the Queue**

1. From a list of tracks, tap the option icon (⋮) on the right hand side.

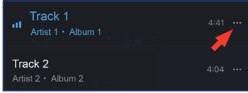

2. Select “Add to Queue”.

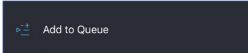

Depending on your selections, you can also add all tracks from an artist, all tracks from an album, or all tracks from a playlist in the queue. You can also replace all tracks in the current queue with the new tracks by selecting “Replace the queue”.

- **Showing the Current Queue**

From the playback screen, tap the queue icon (▶☰) at the top right corner.

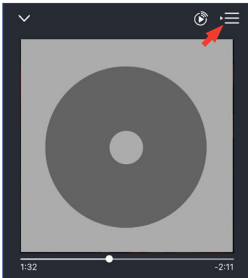

## • Editing the Queue

1. From the current queue, tap the pencil icon (✎) at the top right corner.

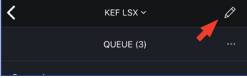

2. To remove a track from the queue, select the track by tapping in the circle and then tap the trash bin icon (🗑).

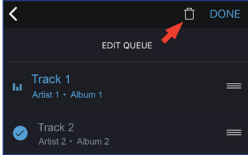

3. To edit the playback sequence, press and hold the three bars (≡) on the right hand side and then drag the track up or down the queue.

### 9.1.1.11 Playlists

A playlist is a list of tracks that can be played back in the preferred sequential order. Playlists can be saved for future listening.

Tap “Playlists” from the main menu to show the playlists created in the KEF Stream app and from your local library. The recently played playlists can also be found on the home screen.

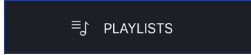

- **Playing Back a Playlist**

Select a playlist and then tap “Play all tracks” to start playback of the playlist.

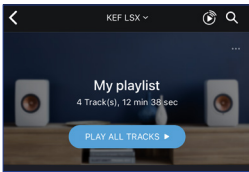

- **Creating a Playlist**

1. Tap “Playlists” from the main menu.
2. Tap “Add New”.

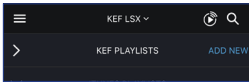

3. Create a name for the playlist and select an image as cover (optional).

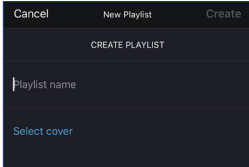

4. Tap “Create”

## • Adding Tracks to a Playlist

1. From a list of tracks or from the playback screen, tap the option icon (⋮) on the right and then select “Add to Playlist”.

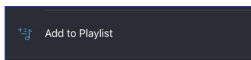

2. Select the playlist you want the track to add to.

 Depending on your selections, you can also add all tracks from an artist or all tracks from an album to the playlist.

## • Editing a Playlist

1. Tap “Playlists” from the main menu.
2. Tap the playlist to be edited.
3. Tap the option icon (⋮) at the top right corner.

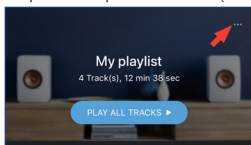

4. Tap “Edit”.
5. To remove a track from the playlist, select the track by tapping in the circle and then tap the dustbin icon (🗑).

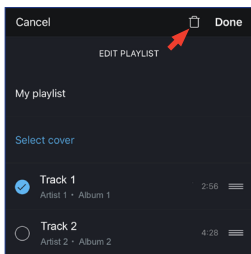

6. To edit the playback sequence, press and hold the three bars icon (≡) on the right hand side and then drag the track up or down the playlist.

- **Deleting a Playlist**

1. Tap “Playlists” from the main menu.
2. Tap the playlist to be deleted.
3. Tap the option icon (•••) at the top right corner.

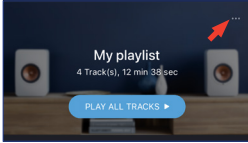

4. Tap “Delete Playlist”.
5. Tap “Confirm”.

## 9.1.1.12 Settings

Tap “Settings” from the main menu to show the settings menu.

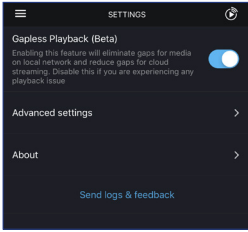

- **Gapless Playback**

Enable this feature to eliminate gaps for media on the local network and reduce gaps for cloud streaming. Disable this feature if you are experiencing any playback issue.

- **Advanced Settings**

- **My Speakers**

This allows you to register a new pair of speakers with the KEF Control app.

- **Analytics**

This allows the KEF Control app to send crash reports and improvement analytics to the manufacturer. We recommend to enable both items.

- **About**

This allows you to:

- Find out current version of the KEF Stream app.
- Visit the KEF website.
- Read the licenses agreement.
- Read the privacy policy.
- Read the FAQ for help and support.



Make use of the “Send logs and feedback” feature at the bottom of the settings menu if you experience problems or want to send us feedback or suggestions.

## 9.1.2 Streaming with AirPlay 2

The speakers are ready for AirPlay 2\* (Firmware 4.0 or later).

1. To stream audio through AirPlay 2, start playback on your iOS device.
2. Tap the AirPlay 2 icon (  ) at the bottom of the playback screen.



3. Select the “KEF LSX” speakers (or the name you have created for the speakers) from the selection menu. The audio output will be played from the selected speakers.

Apple Airplay 2 also extends the speakers to become part of a multi-room wireless music system which can be controlled with iOS devices. If you have more than one pair of speakers connected to the same network, select the pairs for playback of the same audio output at the same time.

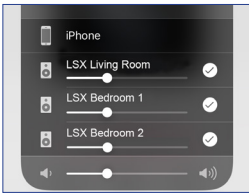

\*AirPlay 2 is available in:

- iPhone, iPad or iPod touch with iOS 11.4 or later
- Apple TV 4K or Apple TV (4th generation) with tvOS 11.4 or later
- Mac or PC with iTunes 12.8 or later

## 9.1.3 Streaming with Spotify Connect



Spotify is a digital music, podcast, and video streaming service that gives you access to millions of songs and other content from artists all over the world. The speakers are ready for the Spotify Connect feature (Firmware 3.0 or later).

1. To stream music through Spotify Connect, tap “Spotify” from the main menu of the KEF Stream app.



2. Tap “Open Spotify”. You will be prompted to the Spotify app.
3. Browse and select a track to play in the Spotify app.
4. Select the speaker icon (  ) at the bottom of the playback screen.
5. Select the “KEF LSX” speakers (or the name you have created for the speakers) from the selection menu. The music will be played from the speakers.

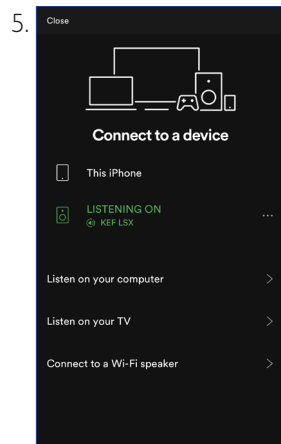
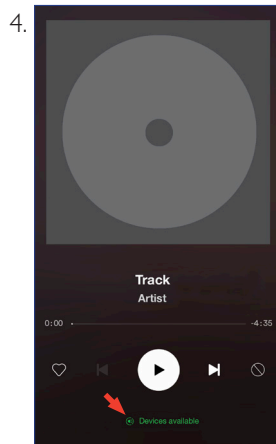
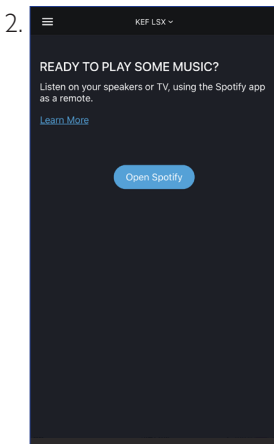



## 9.1.4 Streaming with Qplay



QQ Music is one of China's most popular online music streaming services. QPlay lets you stream music directly from the QQ Music app. The speakers are ready for the QPlay feature (Firmware 3.0 or later).

1. To stream music from QPlay, make sure your iOS/Android device and the speakers are on the same network.
2. Launch the QQ Music app and enable QPlay in the settings.
3. Browse and play a track.
4. Tap the QPlay icon () on the playback screen.

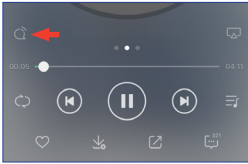

5. Select the “KEF LSX” speakers (or the name you have created for the speakers) from the device list.



## 9.1.5 Streaming with Roon

roon

Roon is a high quality music management system that pulls together music from NAS driver, locally stored music (i.e. on your computer), compatible streaming services and Dropbox to create a searchable, surfable magazine about your music. The speakers are compatible with most of Roon's features (Firmware 3.0 or later).

1. To stream music from Roon, make sure your computer and the speakers are on the same network.
2. At the footer of Roon, click the “Zone Picker” next to volume and then select “KEF LSX” speakers (or the name you have created for the speakers) from the device list.

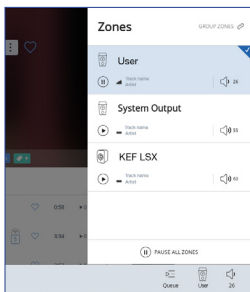

3. The signal path can be found by clicking the little coloured light in the footer.

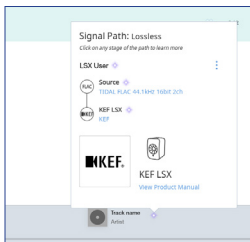

## 9.1.6 Streaming with DLNA

dlina®

The speakers are compatible with common DLNA\* streaming software (e.g. Windows Media Player and foobar2000) and apps (e.g. BubbleUPnP and MConnect Control).

In the settings or setup menu of a DLNA software or app, select “KEF LSX” as the output speakers for audio streaming.

\*Digital Living Network Alliance (DLNA)

## 9.2 Playback with Bluetooth

You can pair your Bluetooth devices (e.g. computers) with the speakers through Bluetooth connection.

### 9.2.1 Selecting Bluetooth Mode

In the KEF Control app, press the Bluetooth button (ⓑ) to switch to Bluetooth Mode.

Or press the source button on the remote control to switch to Bluetooth Mode.

### 9.2.2 Bluetooth Pairing

1. In Bluetooth Mode, check the LED indicator on the Master Speaker.

When the LED indicator slowly flashes blue, the speakers are in the discovery mode and ready to pair with a Bluetooth device.

If the LED indicator is in solid blue, the speakers are already paired with a Bluetooth device. To disconnect the connected Bluetooth device, press and hold the Bluetooth pairing button (B) on the back of the Master Speaker until the LED indicator flashes blue slowly.

2. Turn on the Bluetooth feature of your device and select “KEF LSX” from the list of available devices to pair.

When Bluetooth pairing is done, you will hear an indicator tone from the speakers. The LED indicator will turn solid blue.

The speakers remember your paired device. Once Bluetooth Mode is selected, the speakers will automatically connect with your paired device if it is around.

### 9.2.3 Playback Controls

Use the buttons below for playback controls.

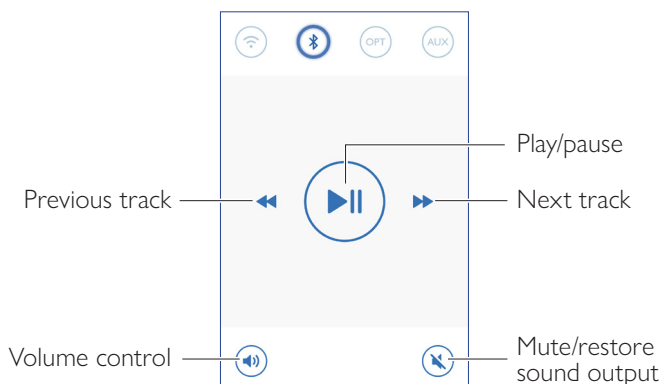

## 9.3 Playback with Optical Input

You can connect your devices with optical output (e.g. TV and game consoles) to the speakers through an optical cable. All playback controls (except adjusting volume) must be done on the connected device.

### 9.3.1 Optical Cable Connection

Connect an optical cable between the optical output port of your device and the optical input port (O) on the back of the Master Speaker.

### 9.3.2 Selecting Optical Mode

In the KEF Control app, press the Optical Mode button (OPT) to switch to Optical Mode.

Or press the source button on the remote control to switch to Optical Mode.



The speakers contain a very high quality optical input which works with most of the televisions via a standard TOSLINK cable. Make sure your television is set to output digital audio in PCM format. Refer to the user manual of your television for details.

## 9.4 Playback with Auxiliary Input

You can connect your devices with 3.5 mm audio output (e.g. turntables, computers, DVD players and CD players) to the speakers through an audio cable. All playback controls (except adjusting volume) must be done on the connected device.

### 9.4.1 Auxiliary Cable Connection

Connect a 3.5 mm audio cable between the audio output jack of your device and the auxiliary input jack (X) on the back of the Master Speaker.

### 9.4.2 Selecting Auxiliary Mode

In the KEF Control app, press the Auxiliary Mode button (AUX) to switch to Auxiliary Mode.

Or press the source button on the remote control to switch to Auxiliary Mode.

## 10. Cleaning and Maintenance

### ⚠ WARNING!

#### Risk of electric shock!

Improper cleaning of the speakers may result in injury.

- Always unplug the power cables from the power socket/outlet before cleaning the speakers.

### NOTICE!

#### Risk of short circuit!

Water and other liquids that have penetrated the housing may cause a short circuit.

- Make sure that no water or other liquids penetrate the housing of the speakers.
- Never immerse the speakers in water or other liquids.

### NOTICE!

#### Risk of damage!

Improper handling of the speakers may result in damage.

- Do not use any aggressive cleaners, brushes with metal or nylon bristles, or sharp or metallic cleaning utensils such as knives, hard scrapers and the like. They could damage the surfaces.
1. Disconnect the power cables of the speakers from the power socket/outlet before cleaning.
  2. Clean the front and rear surfaces of the speakers with a damp cloth and wipe dry with a clean dry cloth.
  3. Use an anti-static cleaner to carefully clean the Uni-Q drivers (speaker cones) with a soft sponge.

## 11. Storage

All parts must be completely dry before being stored.

- Always store the speakers in a dry area.
- Protect the speakers from direct sunlight.
- Store the speakers so that they are not accessible to children.

## 12. FAQ and Troubleshooting

### 12.1 Setup and Network Connection

#### 1. I don't have a home network and/or a smartphone for set-up. It is possible to use LSX without a Wi-Fi network?

Yes you can. However it is highly recommended you connect the LSX to a home network with a live internet connection, as most of the important features (TIDAL, Spotify Connect) and the KEF Control/Stream apps rely on these.

In addition, without an internet connection you will miss out on important updates including bug fixes and new features.

Please refer to "[Setting up without Wi-Fi](#)" for more details on how to disable the network functionality so you can use the LSX without a Wi-Fi network.

#### 2. How do I turn on the Slave Speaker?

The Slave Speaker does not need to be turned on. When you plug the Slave in to the AC, the Slave LED indicator will briefly light up orange and will then go off. This indicates that the Slave is working.

The Master Speaker will automatically find the Slave when powered on.

#### 3. How do I connect the Master and Slave speakers wirelessly?

The Master and Slave Speakers will wirelessly connect to each other automatically after you plug in the power cables and turn on the LSX.

#### 4. When do I need to connect the Master and Slave speakers together with the inter-speaker cable?

A. When you are performing a speaker firmware update.

B. When you prefer listening to music at 96kHz/24bit.

- Wireless Mode: 48kHz/24bit
- Cable Mode: 96kHz/24bit

C. When you are experiencing audio dropouts due to interference.

Cable Mode can be initiated in the KEF Control app. Please refer to [What is Cable Mode?](#) for more details.

## 5. How can I distinguish between the Left and Right speakers?

By default the Master will be the Right channel. It should be placed on the right hand side of the speaker as you face it.

The Slave or Left channel should be placed on the left hand side of the speaker.

You can swap the channels inside the KEF Control app: Settings > Inverse L/R Speakers.

## 6. How far should I separate the Master and Slave speakers?

For the best stereo experience/soundstage, place the speakers 1 to 3 meters apart.

Maximum distances between the Master and Slave Speakers:

- Wireless Mode: Up to 5 meters, although interference from Wi-Fi and Bluetooth can reduce this distance.
- Cable Mode: Up to 8 meters using a shielded Cat-6 Ethernet cable

## 7. What router should I use?

The default router from your Internet Service Provider usually comes with poor speed and range. They are not recommended.

For better streaming stability, especially on Hi-Res music files, a 5GHz Wi-Fi network with a router transmission speed of at least 1300Mbps is recommended.

Below are detailed technical requirements:

- Support IEEE 802.11a/b/g/n
- Use security protocol WPA2

Open networks are not recommended for security reasons.

WEP is an old encryption and may lead to setup and streaming problems.

Refer to the user guide of your router to select the encryption method.

## 8. What is the optimal listening position?

For the best sound experience separate the Master and Slave Speaker by 1 to 3 meters.

Optimal distance between the speakers and the listener will depend on the Master and Slave Speaker separation. Try to aim for approximately the same distance to the listener (i.e. form an equilateral triangle).

In other words, the speaker distance between the Master and Slave Speakers (A) should be the same as the distance between the Slave Speaker and the Listener (B) and the distance between the Master Speaker and the Listener (C).

Also, try angling the speakers inwards towards the listener.

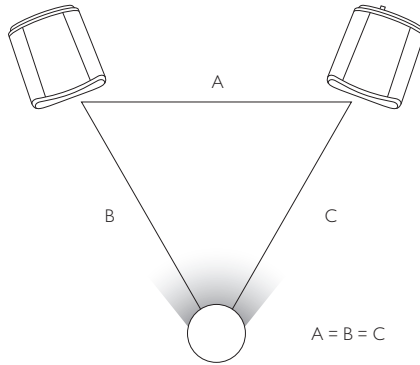



## 9. How to setup the speaker without Wi-Fi network?

Using the LSX without a Wi-Fi network is not recommended and severely limits the usability of the speaker.

In addition, you will miss out important updates including bug fixes and new features.

To set up the speaker without a Wi-Fi network

1. The speaker must be in Setup Mode. The Master Speaker's LED should be alternating between white and orange. If it is not, you will have to factory reset into Setup Mode. Please refer to "[Resetting to Factory Default](#)" for details.
2. Point the physical remote control at the Master Speaker and then hold the "source" button for 5 seconds until the LED alternates between blue and orange. This indicates that Wi-Fi Mode has been disabled. In this mode the Wi-Fi source is disabled.

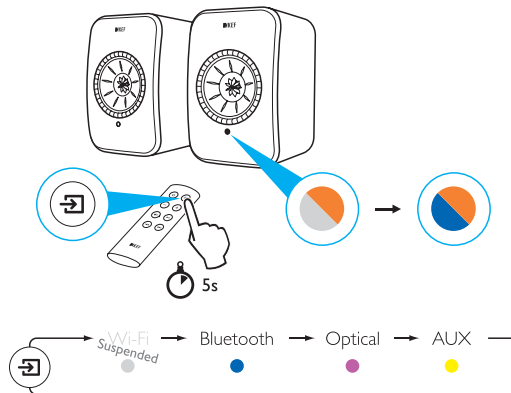

To resume using the LSX with a Wi-Fi connection, reset the speaker to Setup Mode. Please refer to "[Resetting to Factory Default](#)" for factory reset into Setup Mode.

## 12.2 Operation

### 1. How can I turn on and turn off the speakers?

You can either use the physical remote control or the KEF Control app to power the speakers ON or OFF.

On the physical remote control press the power button once to toggle between ON and OFF.

On the KEF Control app from Standby press the desired source to power ON the speaker. Press the active source icon to power OFF the speaker.

Note: Direct playback from Spotify Connect can also wake up the speaker.

### 2. How can I change input sources?

You can either use the physical remote control or the KEF Control app to switch sources.

On the physical remote control press the source button once to toggle between inputs.

On the KEF Control app press the source icon once to switch to a particular input. The colour of each source corresponds to the colour of the LED on the Master Speaker.

### 3. How can I inverse the left and right speakers?

In the KEF Control app: navigate to Settings > Enable/disable Inverse L/R Speaker.

The status of the Master Speaker will change from RIGHT Channel (disabled) to LEFT Channel (enabled).

### 4. What is Cable Mode?

Cable Mode disables the wireless pairing between Master and Slave Speakers.

Cable Mode is needed when:

1. You are performing a speaker firmware update.
2. You prefer listening to music at 96kHz/24bit.
  - Wireless Mode: 48kHz/24bit
  - Cable Mode: 96kHz/24bit
3. You are experiencing audio dropouts due to interference.

## 5. How do I enable/disable Cable Mode?

In the KEF Control app: navigate to Settings > enable/disable Cable Mode

To turn on/off this feature you need to have the inter-speaker cable connected between the Master and Slave Speakers.

If Cable Mode is enabled without the inter-speaker cable being connected, the LEDs on the Master and Slave Speakers will alternate between light blue and yellow. This indicates that the speakers cannot find each other.

If Cable Mode is disabled while the inter-speaker cable is not connected, the Slave Speaker will not receive the signal to switch back to Wireless Pairing Mode. The LED of the Slave Speaker will alternate between yellow and blue. Press the M/S pairing button on the back of the Slave once. The Slave will start looking for the Master. Once found the LED will go off, indicating normal operation.

## 6. How can I adjust the auto-standby time?

In the KEF Control app: navigate to Settings > Standby Mode > set to "Never" or "60 minutes"

Please note that if you set to "Never" the speaker will not power OFF automatically. Remember to power OFF the speaker manually.

## 7. What does "Enable limitation" do?

Enable limitation in the volume settings refers to adjusting the maximum volume of the speaker to a preferred level. For example if you Enable limitation and set the volume limitation to 50, you will not be able to adjust the volume over 50.

## 8. How can I enable maximum volume limitation?

In the KEF Control app: Navigate to Settings > Volume Settings > Enable Limitation

## 9. What do the Hardware Volume Buttons do (iOS only)?

The Hardware Volume Buttons refer to the physical volume buttons on your device.

Disable this feature on iOS devices when you are experiencing conflicts with other music apps streaming over Wi-Fi.

## 10. How can I adjust volume button sensitivity?

In the KEF Control app: Settings > Volume Settings > Volume Button Sensitivity

Adjust the volume steps for each single press of the hardware volume buttons of your device.

## 11. Can I stream Apple Music contents using the KEF Stream app?

Apple Music streaming subscription is not supported.

Purchased or imported music must be downloaded into the local iTunes library for offline listening before it can be streamed to the speaker.

## 12. What file formats do the speakers support?

Format	File extension	Stream type	Sample frequency (KHz)	Audio word size (bits)	Audio channel	Bit rate (kbps)	VBR/CBR
MP3	mp3	MPEG-1/2 Layer-III	8–48	16	2	8–320	Supported
WMA	asf, wma	WMA 2/7/8/9/10	8–48	16	2	5–320	Supported
LPCM	wav	LPCM	8–192	16, 24	2	–	–
FLAC	flac	FLAC	8–192	16, 24	2	–	–
Ogg Vorbis	ogg	Ogg	8–192	16, 24	2	16–128	Supported
AIFF	aiff or aif	AIFF	32–192	16, 24	2	–	–
AAC	m4a aac 3gp 3g2	MPEG-4 AAC MPEG-4 HE AAC (AAC Plus v1/2)	32–96	16	2	16–320	Supported
ALAC	m4a	ALAC	32–192	16, 24	2	–	–

## 13. Can I use the LSX with my TV?

Yes. The LSX contains a very high-quality optical input that will work with the vast majority of televisions via a standard optical TOSLINK cable. Ensure that your television is set to output digital audio in PCM format (please see your television manual for details).

The LSX Aux input also works with an RCA/ 3.5mm analog output on common televisions.

## 14. At what resolution does my speaker play?

Playback resolution depends on the connection between Master and Slave.

In Wireless Mmode, the resolution is at 48kHz/24bit. Media above 48kHz/24bit will be downsampled. Media below 48/kHz/24 bit will be upsampled.

In Cable Mode, the resolution is at 96kHz/24bit. Media above 96kHz/24bit will be downsampled. Media below 96/kHz/24 bit will be upsampled.

## 15. How do I stream music using Spotify Connect?

Spotify Connect allows you to stream music directly from Spotify app.

1. Connect your speaker to your Wi-Fi network.
2. Open up the Spotify app on your phone, tablet or laptop whilst connected to the same Wi-Fi network.
3. Play a song and select Devices Available.
4. Select your speaker and start listening.

For more information on how to use Spotify connect and country compatibility, please look at the following webpage (<http://www.spotify.com/connect>).

## 16. How do I stream music using Qplay?

QQ Music is one of China's most popular online music streaming services. QPlay allows you to stream music directly from the QQ Music app.

How to use QPlay

1. Connect your iOS/Android device and speaker to the same network.
2. Open the QQ Music app and enable QPlay in Settings.
3. Play a song.
4. Press the QPlay icon 'Q' on the playing page then choose your speaker from the device list.

For more information on QQ Music, please see <https://y.qq.com>.

## 12.3 KEF Control App and KEF Stream App

### 1. What is the minimal supported Android version for KEF Control app and KEF Stream app?

The KEF Control app supports Android 4.4 and above.

### 2. What is the minimal supported iOS version for KEF Control app and KEF Stream app?

The KEF Control app supports iOS10 and above.

### 3. What are the differences between the KEF Control app and the KEF Stream app?

The KEF Control app provides set-up and comprehensive remote control functionality for LS50 Wireless and the LSX.

The KEF Stream app allows you to stream music from your local library, media servers, TIDAL and Spotify Connect to LS50 Wireless and the LSX.

## 12.4 Maintenance

### 1. How do I clean the speaker cone?

Regular cleaning is important in order to keep the driver free from dirt and ensure optimal acoustic performance. Use an anti-static cleaner to clean the Uni-Q driver carefully with a soft sponge.

### 2. How do I clean the fabric areas of the LSX?

#### Normal cleaning

Regular cleaning is important in order to keep the fabric looking its best and to prolong its life. Vacuum frequently, ideally every week. May also be vacuum cleaned with a soft brush.

#### Stain removal

Scrape off any liquids or hardened residues with a spoon or a scoop. Any loose particles must be vacuum cleaned before further cleaning.

Liquids must be soaked up with an absorbent napkin or cloth.

Remove non-greasy stains by carefully dabbing with a lint-free cloth or sponge wrung out in warm water. Edge marks can be avoided by dabbing gently in circular motions towards the center of the stain with a clean lint-free cloth. Remove greasy stains by using appropriate detergents or solvents. In all cases, we recommend you test stain removal agents on an inconspicuous area first to see if there is any effect on the fabric.

#### Warning

- 1) Do not rub the material hard because this could result in loss of colour or potentially damage the nap.
- 2) Never use unconcentrated detergents or bleach, ammonia or soap intended for hard surfaces.

## 12.5 Comments and Requests

### 1. I have a feature request, where can I submit a request?

Please send your requests to [dev@kef.com](mailto:dev@kef.com).

## 12.6 Troubleshooting

### 1. The LED on the Slave speaker doesn't show up. Is there something wrong?

In normal operation the LED on the Slave Speaker will not light up. The LED on the Slave Speaker will only light up if there is a problem.

### 2. I cannot find my LSX in the Wi-Fi list during set-up (Step 3), what should I do?

It may take up to a minute for the LSX to become discoverable after the power is turned on. If you are still unable to find the LSX after a minute please perform a Factory Reset.

1. Use a paperclip/pin to hold the reset button (marked with a triangle) on the back of the Master Speaker for approximately 5 seconds until the back LED flashes orange. Wait until the back LED stops flashing.
2. Close down the app completely.
3. Unplug the power cable from the Master Speaker.
4. Wait approximately 60 seconds.
5. Reinsert the power cable.
6. The Master Speaker LED should be alternating between white and orange. It may take up to 1 minute for the LSX to become discoverable.
7. Run the KEF Control app, choose 'Setup New Speaker' and follow the instructions.

If the problem persists please check the following:

The LSX broadcasts at 2.4G on channel 1. If your router is also broadcasting at 2.4G on channel 1, you may not be able to see your LSX. Try to change your router to another channel (please see your router manual for details).

Disable any VPN apps on your phone as they may interfere with Wi-Fi detection.

If the problem persists, please send a log with a description of the problem from inside the KEF Control app (Settings > Send Logs & Feedback) or contact [support@kef.com](mailto:support@kef.com).

### 3. I cannot see my Wi-Fi network in the KEF Control app during set-up (Step 4), what should I do?

The app checks with the speaker which Wi-Fi networks are visible. If the speaker can't see your network, move the Master speaker closer to the router. If the problem persists, connect a LAN cable directly from the Master Speaker to the router.

If the app still can't see your Wi-Fi network during setup, please send a log from inside the KEF Control app (Settings > Send Logs & Feedback) or contact [support@kef.com](mailto:support@kef.com).

### 4. I am unable to see my LSX inside the network, what should I do?

Make sure the speaker is powered on and already onboarded to your network. The LED of the Master Speaker should have a solid colour.

1. Make sure you are connected to the network where the speaker is onboarded
2. Select your speaker and press "Connect"
3. In the KEF Control app: Navigate to "Add new speaker" > "Connect to existing" > "Search again"
4. If the speaker does not show up in your network:
  - Pull the power plug from both the Master and Slave Speakers
  - Wait approximately 60 seconds
  - Plug both speakers back into the power
  - Run the KEF Control app
  - Select your speaker from the speaker drop down menu

If the problem persists, please send a log with a description of the problem from inside KEF Control app: Settings > Send Logs & Feedback to [dev@kef.com](mailto:dev@kef.com).

### 5. There is a bug or an issue with the KEF Control app, how do I report this issue?

KEF strives to deliver the best user experience and it is our wish to deliver you a bug free app. Unfortunately, due to many factors (e.g. device, firmware, network setup, etc) this may not always be the case. In these cases, we rely on our KEF users to help us out.

Please use the "Send logs & feedback" option inside the corresponding app. If you find an issue inside the KEF Stream app use KEF Stream app to send a log, and if you find an issue with KEF Control app use KEF Control to send a log.

It is important to add a description about the issue you encountered, the steps to reproduce it, a video, screenshots, etc. The more information we have the easier it will be for our developers to identify the root cause of the issue and develop a fix.



## 6. There is no sound from either speaker.

1. Please make sure that the power cable is plugged in securely both to the speaker and the AC socket. When it is correctly plugged in, the LED on the Master Speaker should light up.
2. Please make sure the volume is not muted (the source LED will be blinking).
3. Try adjusting the volume on the KEF Control app or physical remote control.

If the problem persists please contact your local KEF representative or send an email to [support@kef.com](mailto:support@kef.com).

## 7. There is no sound from my Slave Speaker.

1. Please make sure that the power cable is plugged in securely both to the speaker and the AC socket. When it is correctly plugged in, the LED on the Slave Speaker should light up briefly orange and then go off.
2. Please make sure the volume is not muted (the source LED on the Master Speaker will be blinking)
3. Try adjusting the volume on the KEF Control app or the physical remote control

If the problem persists please contact your local KEF representative or send an email to [support@kef.com](mailto:support@kef.com).

## 8. I am experiencing dropouts in my music listening.

If the speakers are experiencing dropouts this may be caused by poor network connection.

1. It is recommended you connect over 5G.
2. It is recommended you keep the router in line of sight.
3. If the problem persists, try connecting the speaker via the LAN cable directly from router to speaker ((N) network port).

## 9. I am experiencing dropouts on my Slave Speaker.

The wireless pairing technology works over a 2.4 GHz frequency. It is recommended you onboard the speaker to a 5G network rather than a 2.4 G network.

Devices such as microwaves, cordless phones, Bluetooth, mouse or Wi-Fi devices connected to 2.4GHz that run on the same frequency may cause interference and result in dropouts. Try to remove this type of device from the vicinity. You can also make use of network analyzer apps available on the market to check the network and interference status.

If the problem persists due to heavy interference, please use Cable Mode by plugging in the inter-speaker cable to the Master and Slave Speakers. Enable Cable Mode inside the KEF Control app: Settings > Enable Cable Mode.

## 10. I notice a delay between video and audio output.

There is a 40 millisecond delay in audio when the speaker is paired wirelessly. This is to make sure the audio between the Master and Right Speakers is synchronised.











There are some TV or video player apps (e.g VLC) that can compensate for this audio delay. Alternatively, you can use Cable Mode by plugging in the inter-speaker cable to the Master and Slave Speakers. Enable Cable Mode inside the KEF Control app: Settings > Enable Cable Mode.







## 12.7 Resetting to Factory Default



1. Use a paperclip/pin to press and hold the reset button (marked with a triangle) on the back of the Master Speaker for approximately 5 seconds until the LED light above the button flashes orange. Wait until the LED light stops flashing.
2. The LED indicator of the Master Speaker should flash white and orange.
3. Launch the KEF Control app and follow the instructions to set up the speakers.

## 12.8 LED Indicators

The connection and operation status can be easily checked through the colours and patterns of the LED indicators on the Master and Slave Speakers. Refer to the table below.

Speaker	Pattern	Status
Master	 Flashing white and orange	LSX is ready to connect to a Wi-Fi network. Launch the KEF Control app to set up the speakers.
Master	 Flashing orange <b>slowly</b>	The speakers are in Standby Mode and trying to connect to a Wi-Fi network.
Master	 Solid orange	The speakers are in Standby Mode and connected to the Wi-Fi network.
Master	 Flashing orange <b>quickly</b>	<p>The speakers are unable to connect to a Wi-Fi network.</p> <ul style="list-style-type: none"> <li>• Make sure your router is turned on.</li> <li>• Move the Master Speaker closer to the router. If the problem persists, connect the Master Speaker to your router by a LAN cable.</li> <li>• If this happens right after the network connection, it is likely that the Wi-Fi password is incorrect. Perform factory reset (see chapter <a href="#">“Resetting to Factory Default”</a>) and try the connection process again.</li> </ul>
Master	 Solid white	The speakers are operating in Wi-Fi mode.
Master	 Solid blue	The speakers are operating in Bluetooth Mode and a device is already paired with the speakers.
Master	 <b>Slowly</b> flashing blue	The speakers are in the Bluetooth discovery mode and are ready to pair with a Bluetooth device.
Master	 Solid green	The speakers are in Spotify Connect Mode.
Master	 Solid purple	The speakers are operating in Optical Mode.
Master	 Solid yellow	The speakers are operating in AUX Mode.
Master	 Flashing white	The speakers are muted in Wi-Fi Mode.

Speaker	Pattern	Status
Master	 Flashing blue	The speakers are muted in Bluetooth mode.
Master	 Flashing purple	The speakers are muted in Optical Mode.
Master	 Flashing yellow	The speakers are muted in AUX Mode.
Master	 Flashing white and blue	<p>The Master Speaker is in wireless pairing mode searching for the Slave Speaker.</p> <ol style="list-style-type: none"> <li>1. Make sure Cable Mode is disabled on the KEF Control app (Settings &gt; Cable Mode).</li> <li>2. On the Slave Speaker, press the (M) M/S Pairing button once. The Slave Speaker will search for the Master Speaker for reconnection.</li> </ol>
Master and slave	 Flashing light blue and yellow	<p>Cable Mode is enabled and the connection between the speakers is interrupted.</p> <ol style="list-style-type: none"> <li>1. Make sure the inter-speaker cable is connected between the Master and the Slave Speakers.</li> <li>2. Make sure the inter-speaker cable is inserted in the correct connection ports: “(T) To Slave” on the Master Speaker and “(T) To Master” on the Slave Speaker.</li> </ol>
Slave	No LED light	The Slave Speaker is operating normally.
Slave	 Flashing white and blue	<p>The Slave Speaker is in the wireless pairing mode searching for the Master Speaker.</p> <ol style="list-style-type: none"> <li>1. Make sure Cable Mode is disabled on the KEF Control app (Settings &gt; Cable Mode)</li> <li>2. On the Master Speaker, press the (M) M/S Pairing button once. The Master Speaker will search for the Slave Speaker for reconnection.</li> </ol>

Speaker	Pattern	Status
Master and Slave	 Flashing red <b>slowly</b>	<p>The firmware update process failed.</p> <ol style="list-style-type: none"> <li>1. Unplug the power cables from both speakers.</li> <li>2. Wait approximately 60 seconds.</li> <li>3. Plug the power cables back to both speakers.</li> <li>4. Perform the firmware update again on the KEF Control app.</li> </ol> <p>If the problem persists, please send a log from the KEF Control app (Settings &gt; Send Logs &amp; Feedback) or contact <a href="mailto:support@kef.com">support@kef.com</a>.</p>
Master and Slave	 Flashing red <b>quickly</b>	<p>System error.</p> <ol style="list-style-type: none"> <li>1. Pull the power cables from both speakers.</li> <li>2. Wait approximately 60 seconds.</li> <li>3. Plug the power cables back to both speakers.</li> <li>4. The LED indicator of the Master Speaker should be slowly flashing orange, indicating that the speakers are attempting to connect to the network.</li> </ol> <p>If the problem persists, please contact your KEF dealer.</p>
Master and Slave	 Flashing white, blue, purple and yellow	<p>The firmware is being updated. Do not unplug the power cables until the firmware update is completed. If you encounter any issues during the firmware update, do not interrupt the process and contact your local representative or contact your local KEF dealer.</p>

## 13. Specifications

Model	LSX
Type	Wireless speaker
Drive units	Uni-Q driver array: HF: 19 mm (0.75 in.) aluminium dome LF/MF: 115 mm (4.5 in.) magnesium/aluminium alloy cone
Frequency range (-6 dB) measured at 85 dB/1 m	49 Hz–47 kHz (More bass extension) 52 Hz–47 kHz (Standard) 55 Hz–47 kHz (Less bass extension) Depending on speaker settings
Frequency response ( $\pm 3$ dB) measured at 85 dB/1 m	54 Hz–28 kHz (More bass extension) 59 Hz–28 kHz (Standard) 69 Hz–28 kHz (Less bass extension) Depending on speaker settings
Power input	100–240 VAC 50/60 Hz
Amplifier output power	LF: 70 W HF: 30 W
Max SPL	102 dB
Dimension (H $\times$ W $\times$ D)	240 $\times$ 155 $\times$ 180 mm (9.5 $\times$ 6.1 $\times$ 7.1 in.)
Resolution	Support up to 192 kHz / 24 bit Depending on source resolution
Master and Slave Speaker connection:	Wireless: Proprietary 2.4 GHz Wired: Proprietary RJ45 connection Depending on connection settings

	Master Speaker	Slave Speaker
Inputs	2.4 GHz/5 GHz Dual-band Wi-Fi network Bluetooth 4.2 with aptX® codec TOSLINK Optical 3.5 mm Auxiliary Input RJ45 10/100 Mbps Ethernet (for network)	Not applicable
Output	Subwoofer output 5 V, 2 A DC output	Not applicable
Wi-Fi network standard	IEEE 802.11a/b/g/n	Not applicable

Wi-Fi network frequency band	Dual-band 2.4 GHz/5 GHz	Not applicable
Bluetooth range	10 m	Not applicable
Bluetooth memory	8 devices	Not applicable
Bluetooth frequency	2.402 GHz–2.48 GHz	Not applicable
Bluetooth power	2.5 mW (Bluetooth Class 2 Device)	Not applicable
Weight	3.6 kg (7.9 lbs)	3.5 kg (7.7 lbs)

Wireless performance depends on many factors, including network traffic, distance from access point, room materials and construction, interference and other adverse conditions.

For further information and troubleshooting, please visit the KEF website: [KEF.COM](http://KEF.COM)

KEF reserves the right, in line with continuous research and development, to amend or change specifications without prior notice. E. & O.E

### Bluetooth®

The Bluetooth® word mark and logos are registered trademarks owned by Bluetooth SIG, Inc. Other trademarks and trade names are those of their respective owners.



Qualcomm aptX is a product of Qualcomm Technologies International, Ltd.

Qualcomm is a trademark of Qualcomm Incorporated, registered in the United States and other countries, used with permission. aptX is a trademark of Qualcomm Technologies International, Ltd., registered in the United States and other countries, used with permission.

## 14. Disposal

### 14.1 Disposing of the Packaging

Sort the packaging before you dispose of it. Dispose of paperboard and cardboard with the recycled paper service and wrappings with the appropriate collection service.

### 14.2 Disposing of the Speakers

**Old appliances may not be disposed of in the household waste!**

Should the speakers no longer be capable of being used at some point in time, dispose of them in accordance with the regulations in force in your city or county. This ensures that old appliances are recycled in a professional manner and also rules out negative consequences for the environment.

### 14.3 Disposing of the Battery

**Batteries may not be disposed of with household waste!**

As the end user you are required by law to bring all batteries, regardless whether they contain harmful substances\* or not, to a collection point run by the communal authority or to a retailer, so that they can be disposed of in an environmentally friendly manner.

\* labeled with: Cd = cadmium, Hg = mercury, Pb = lead



## 15. Appendix

### 15.1 Explanation of symbols

#### 15.1.1 Warning Symbols



The lightning flash with arrowhead symbol, within an equilateral triangle, is intended to alert the user to the presence of uninsulated “dangerous voltage” within the products enclosure that may be of a sufficient magnitude to constitute a risk of electrical shock to persons.



The exclamation mark within an equilateral triangle is intended to alert the user to the presence of important operating and maintenance (servicing) instructions in the literature accompanying the appliance.

#### 15.1.2 Regional Symbols

##### Europe and North America



This marking indicates that this product should not be disposed with other household wastes throughout the EU. To prevent possible harm to the environment or human health from uncontrolled waste disposal, recycle it responsibly to promote the sustainable reuse of material resources.

To dispose of your used device, please use the proper collection system or contact the retailer where the product was purchased, they may be able to take the product for environmentally safe recycling.



Products marked with this symbol meet all applicable Community regulations for the European Economic Area.



This UL symbol means UL found us that representative product samples met UL's requirements (Canada, United States).



This UL Energy Certification Mark symbol means UL has certified that the product meets the requirements for energy efficiency and is consistent with technical and legal requirements of the United States and Canadian markets.



This FCC mark certifies that the electromagnetic interference from the device is under the limits approved by the Federal Communications Commission in the US.

---

## Asia-Pacific

---



The Regulatory Compliance Mark (Australia, New Zealand) indicates that the product complies with the relevant guidelines of the ACMA as well as corresponding government requirements for the safety of electrical devices.

---



The symbol indicates that the product meets the specified safety requirements of Singapore Consumer Protection Registration Scheme.

---



The Japan PSE Mark Certification indicates that the product meets the technical requirements of the Electrical Appliance and Material Safety Law (DENAN).

---

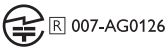

These marks indicate compliance with technical and design requirements for telecommunication terminal equipment in Japan.

---

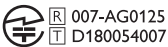

The Korean Certification mark indicates that the product complies with Korea's product safety requirements for electrical and electronic equipment.

---



The China Compulsory Certificate mark indicates that the product meets the safety requirements of the Chinese national standards (Guobiao).

---



The product is only suitable for use in areas under 2,000 m above sea level (China).

---



RoHS (China): This product contains certain hazardous substances and can be used safely during its environmental friendly use period (10 years). The product should enter into the recycling system after its environmental friendly use period.

---



RoHS (Taiwan): This symbol means that the product does not exceed the specified concentration limits for specific hazardous substances.

---



The product obtained the certification from the Taiwan National Communications Commission (NCC) for low-power radio frequency appliances.

---



This MCMC certification mark indicates that a communications device is certified for compliance to standards according to the Communications and Multimedia (Technical Standards) Regulations 2000 in Malaysia.

---

## 15.2 Integration with Home Automation Control System

Drivers for integrating LSX to the most common Home Automation Control System are available for download.

Control 4	<a href="https://www.intrinsicdev.co.uk/downloads/kef_ls50w_c4/">https://www.intrinsicdev.co.uk/downloads/kef_ls50w_c4/</a>
Crestron	<a href="https://www.intrinsicdev.co.uk/downloads/kef-ls50w-for-crestron/">https://www.intrinsicdev.co.uk/downloads/kef-ls50w-for-crestron/</a>
Elan	<a href="https://www.intrinsicdev.co.uk/downloads/kef_ls50w_elan/">https://www.intrinsicdev.co.uk/downloads/kef_ls50w_elan/</a>
RTi	<a href="https://www.intrinsicdev.co.uk/downloads/kef-ls50w-for-rti/">https://www.intrinsicdev.co.uk/downloads/kef-ls50w-for-rti/</a>



For support and information on the above drivers, please contact our development partner Intrinsic(DEV) directly: <https://www.intrinsicdev.co.uk/>



Savant: Drivers for the Savant platform are embedded and downloaded as part of the Savant software suite. Please contact your authorized Savant dealer for information regarding integration with the Savant control platform.

### Important information for integrators and developers:

- These drivers do not control streaming (handled by the app).
- LSX supports Wake On LAN (WOL)
- The following commands are available via IP Control:
  1. Input Select
  2. Volume +/-
  3. Mute toggle

## 15.3 IR Command Codes

LSX works with universal programmable remote control provided that the remote control manufacturers have implemented KEF IR command codes in their remote controls.

The following table lists the command codes required.

<b>Code Format:</b>	NEC
<b>Factory Code:</b>	0x01

	<b>Functions</b>	<b>Function codes</b>
1	Power On/Off Toggle	0x40
2	Mute/ Unmute Toggle	0x20
3	Play/Pause	0x18
4	Next	0x52
5	Source toggle	0x58
6	Volume Up	0x60
7	Volume Down	0xA0
8	Previous	0xD2
9	Power ON	0x38
10	Power OFF	0x3A
11	Mute	0x48
12	Un-Mute	0x4A
13	Source: Wi-Fi	0x30
14	Source: Bluetooth	0x2A
15	Bluetooth Pairing	0x98
16	Source: AUX	0x02
17	Source: Optical	0x0A
18	Source: USB	0x1A
19	Preset Volume (30%)	0x78

## Contact KEF

Country	Customer Support Number	Customer Support Email
UK	+44 1622 672 261	support.uk@kef.com
Germany	0201-17039-0	Info.de@kef.com
Austria	0201-17039-1	Info.de@kef.com
Belgium	+32(0)2/468 30 33	Info.be@kef.com
Bulgaria	+359 298 67 329	info@homecinema-bg.com
Croatia	+385 (1) 383 28 14	info@sigma-audioconcept.hr
Cyprus	+357 2275 7738	michael.pk@cytanet.com.cy
Czech Republic	+420 272 658 390	ludvik.zabak@perfectsoundgroup.cz
Denmark	+45 86 21 66 18	cb@bulowsteensen.dk
Finland	+358(0)40 561 4597	rfo@highendstudio.fi
France	+33 2 47 80 48 61	nadia.Louloup@kef.com
Greece	+30 210 6741363	info@etyt.gr
Italy	+39.049.7450108 / 109	support.eu@kef.com
Netherlands	00-49-201-17039-0	support.de@kef.com
Portugal	+351 213162048	joao.cunha@infiniteconnections.pt
Russia	+7 495 788-4500	shashenkov@mms.ru
Switzerland	0201-17039-0	support.de@kef.com
Sweden	+46 87 77 2001	info@digitalbild.se
Ukraine	+38 044 53 197 30	stepin@compass.ua
USA	+1 732 683 23 56	support.us@kef.com
Canada	+1 732 683 23 56	support.us@kef.com
Argentina	+54 114-796-696/ +54 11 4583 5235	ivojuri@digitalcinema.com.ar info@distea.com.ar
Brazil	+55 45 3523 9117 +55 45 9972 1058	contato@mdeletro.com.br
Chile	Comunicaciones Ak-Itec: +56 2-735-2765	akitec@akitec.cl
	Music World : +56 2-334-2300	info@musicworld.cl
Colombia	SchallerTech (5)3681516 / (1)7435600	greg@schallertech.com
	LFL Audio (571)6220668	tiendaandino@lfaudio.com
Mexico	+52 (55) 5543 4763	kef@equiposycintas.com.mx
Egypt	+20 25 19 54 74	hossam.kamal@applicationseg.com
Dubai	+97148879694	support.ap@kef.com
Iran	Jam International : +98 21 8882 6086	support.ap@kef.com
Saudi Arabia	TBD	ctuck@paragonarabia.com
Turkey	+90 212 285 00 07	import@extreme-audio.com
Israel	+972 54-2232332	support.ap@kef.com
Kuwait	TBD	support.ap@kef.com
South Africa	+27 (12) 6652932	support.ap@kef.com
Australia	+61 2 9561 0799	enquiry@advanceaudio.com.au
China	+86 (21) 6475 2292	info.cn@kef.com
Hong Kong	+852 2410 8188	support.hk@kef.com
India	+ 91 80 65686722	support@profx.com
Indonesia	+6221 62203789	kef.emails@gmail.com
Japan	+81 (0) 3-3528-2101	support@kef.jp
Macao		support.hk@kef.com
Malaysia	603-5882 1693	info@perfecthifi.com.my
New Zealand	+64 9 582 0910	info@avalon.co.nz
Phillippines	+63 22431931	ao@cobankiat.com.ph
South Korea	+82 2 2106 2875	sovicov@sovico.co.kr
Singapore	+65 6338 7011 / +65 6748 8918	support.sg@kef.com
Taiwan	+886 (2) 2723 0868	support.tw@kef.com
Thailand	+66 02 448 5489 / +66 02 448 5465 6	home_hifi@hotmail.com