

Model Number: XLH12-236M SS

Special Notes: LED lights. This model is not available with heat lamps. This model is available in stainless steel only. Optional finished duct/duct covers are available in standard and custom sizes.

WIDTH:	36"
DEPTH:	21"
HEIGHT:	12"
CFM:	600
SONES:	6.5
AMPS:	4.0
# LIGHTS:	2

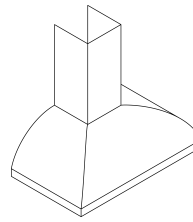
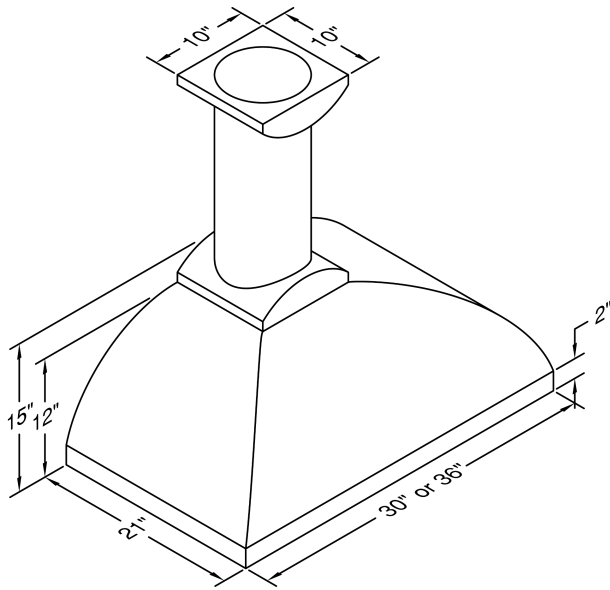

Hood with optional 10" x 10" duct cover.

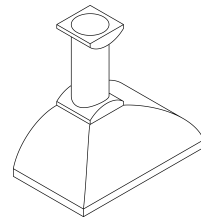

Hood with optional duct collars and finished round duct.

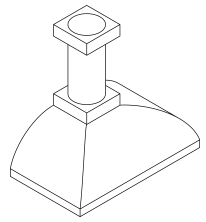

Hood with optional square duct collars and finished round duct.

CONNECTION DIAGRAM

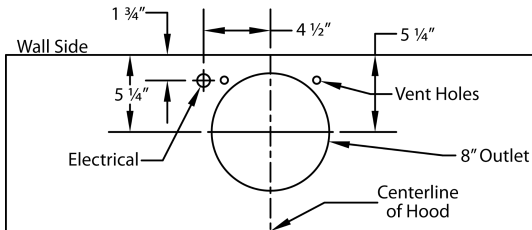

600 CFM B200 Dual Blower (Top View)

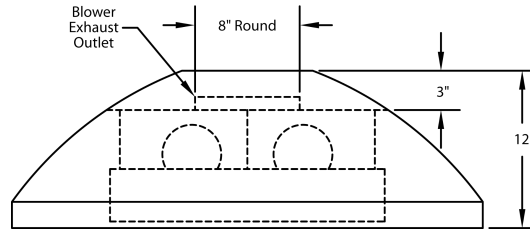

(Front View)

REC. MOUNTING HEIGHT*

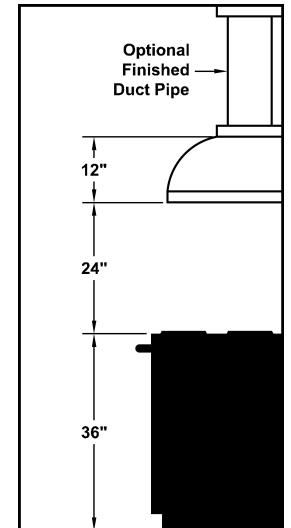

* Exceeding recommended mounting height may compromise performance.

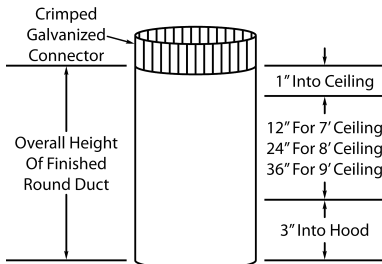

Finished Round Duct (two required)

Note: Top end of finished round duct is crimped to allow for duct connection in the ceiling (crimp is not included in the overall height of the finished round duct).

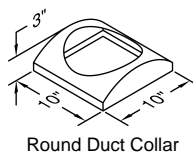

Round Duct Collar

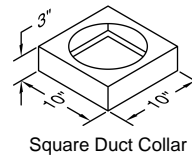

Square Duct Collar

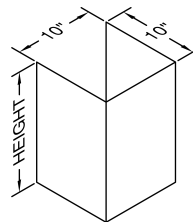

10" x 10" Square Duct Cover

ELECTRICAL/MECHANICAL SPECIFICATIONS FOR BLOWER UNIT

MODEL	VOLTS	AMPS+	HZ	RPM	CFM SP@0.0"	EQUIV CFM\$	CFM SP@0.1"	CFM SP@0.2"	CFM SP@0.3"	MIN. ROUND DUCT SIZE	SONES#
B200 Dual	115	4.0	60	1550	600	900	531	480	430	8" (50 sq. in.)	6.5

+ This model is equipped with LED lighting: (2 lights: 30" - 36").

\$ Because the Power Lung™ blower uses centrifugal filtration rather than conventional baffle or mesh filters, the Power Lung™ blower can handle cooking equipment with higher cubic feet per minute (CFM) requirements and can deliver equivalent CFM much more efficiently than other filtration systems. When comparing the Power Lung™ with other blower units made by other manufacturers, use the "Equivalent CFM".

Ratings in accordance with the Standard Test Code by the Energy Systems Laboratory of the Texas Engineering Experiment Station.