

Model Number: SLH6-K36

Special Notes: LED GU10 lighting. This model is not available with heat lamps. This model is available in black, biscuit, gunsmoke, stainless steel, and white. No customizations.

WIDTH:	36"
DEPTH:	19 1/2"
HEIGHT:	6"
CFM:	250
SONES:	7.4
AMPS:	3.5
# LIGHTS:	2

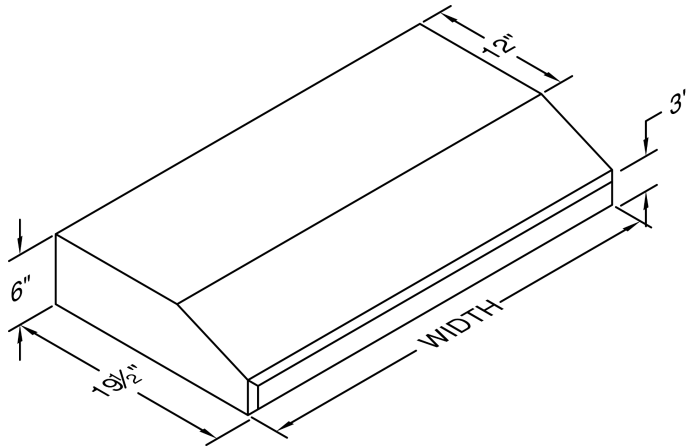

The VP521 transition is available for top vent applications at an additional charge.

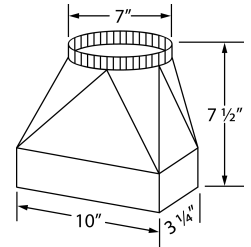

CONNECTION DIAGRAM

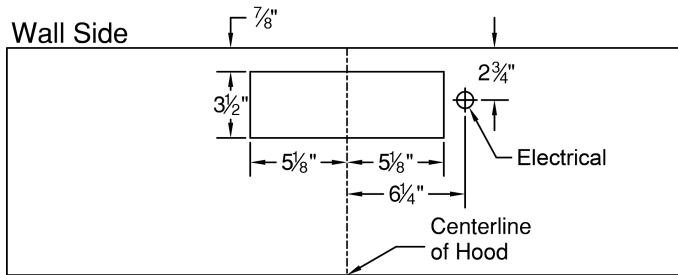

(Top View)

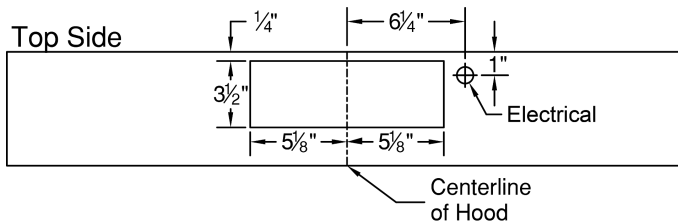

(Wall Cutout, Viewed from Front)

REC. MOUNTING HEIGHT*

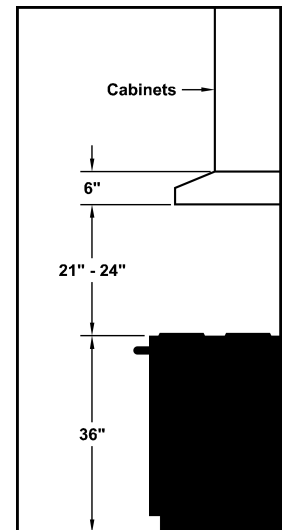

* Exceeding recommended mounting height may compromise performance.

ELECTRICAL/MECHANICAL SPECIFICATIONS FOR BLOWER UNIT

MODEL	VOLTS	AMPS+	HZ	RPM	CFM SP@0.0"	EQUIV CFM\$	CFM SP@0.1"	CFM SP@0.2"	CFM SP@0.3"	MIN. ROUND DUCT SIZE	SONES#
K250 (Top Vent)	115	3.5	60	1550	250	375	223	220	190	7" (38 sq. in.)	7.4

+ This model is equipped with LED GU10 lighting: (2 lights: 24" - 41", 3 lights: 42")

\$ Because the Power Lung™ blower uses centrifugal filtration rather than conventional baffle or mesh filters, the Power Lung™ blower can handle cooking equipment with higher cubic feet per minute (CFM) requirements and can deliver equivalent CFM much more efficiently than other filtration systems. When comparing the Power Lung™ with other blower units made by other manufacturers, use the "Equivalent CFM".

Ratings in accordance with the Standard Test Code by the Energy Systems Laboratory of the Texas Engineering Experiment Station.