

Model Number: PRH18-M54

Special Notes: LED GU10 lighting. M600 and M1200 blowers are sold separately. Features stainless steel baffle filters.

WIDTH:	54"
DEPTH:	24"
HEIGHT:	18"
CFM:	See Chart
SONES:	N/A
AMPS:	See Chart
# LIGHTS:	4

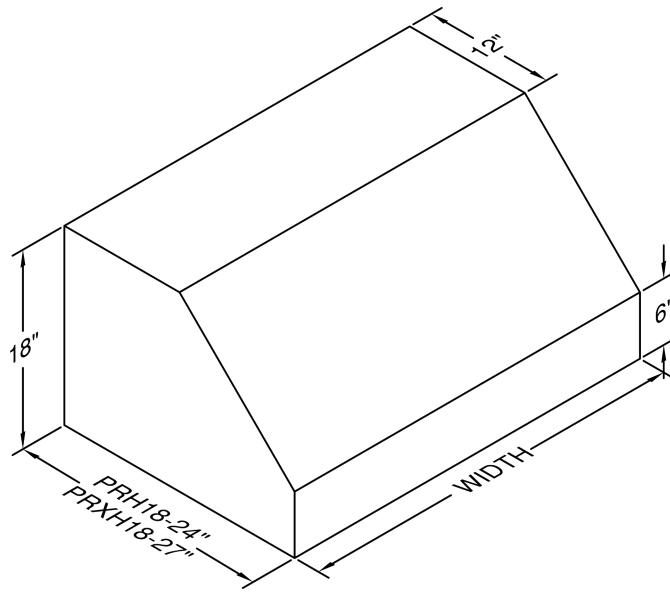

CONNECTION DIAGRAM

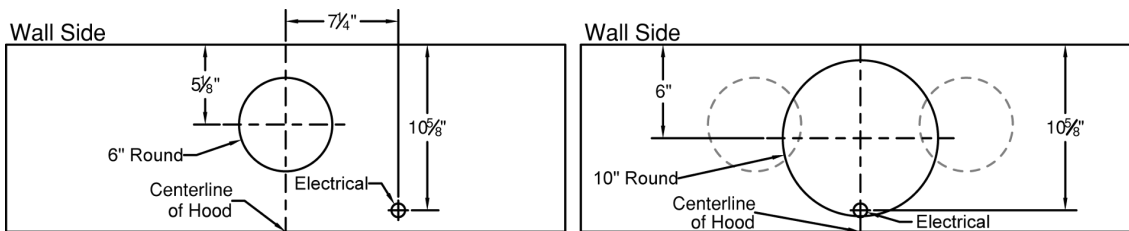

M600 & M1200 Connection Diagrams

REC. MOUNTING HEIGHT*

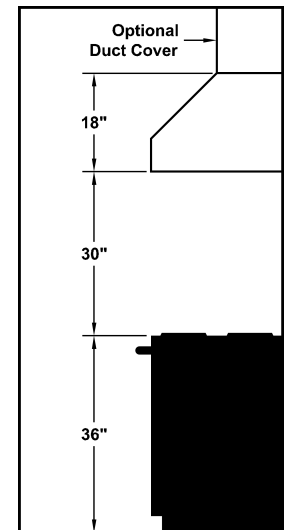

* Exceeding recommended mounting height may compromise performance.

VP566 Transition Details (Included with M1200)

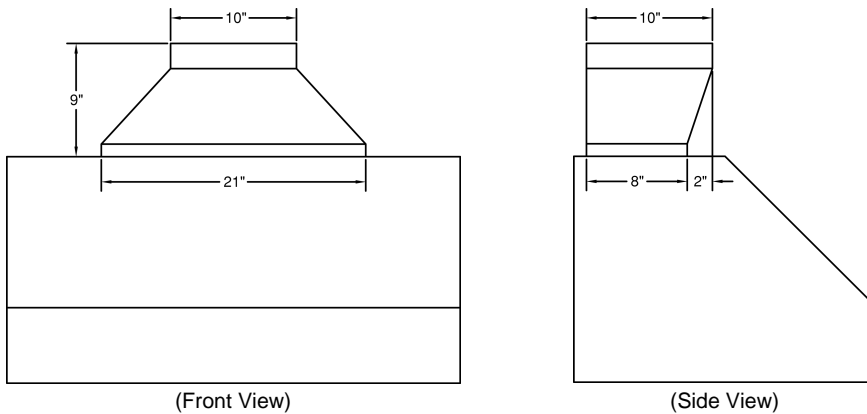

(Front View)

(Side View)

(CHART B)

SPEED	CFM @ 0.1" S.P.		
	M600	WHM300 *	M1200
1	240	240	420
2	300	300	645
3	500	-	865
4	625	-	1015

* The WHM300 is a wiring harness that when used with the M600 blower (sold separately) will disable blower speeds exceeding 300 CFM.

(CHART A) ELECTRICAL/MECHANICAL SPECIFICATIONS FOR BLOWER UNIT

MODEL	VOLTS	AMPS+	HZ	CFM SP@0.0"	CFM SP@0.1"	CFM SP@0.25"	CFM SP@0.5"	CFM SP@0.75"	MIN. ROUND DUCT SIZE
M600 Single	115	5.0	60	630	625	615	600	580	6" (28in. ^{^2})
M600 w/WHM300 Harness	115	5.0	60	302	300	295	288	278	6" (28in. ^{^2})
M1200 Dual	115	10.0	60	1035	1015	1000	995	915	10" (79in. ^{^2})

+Add 0.5 amp for each halogen light. Hoods are available with halogen lights (2 lights: 30" - 41", 3 lights: 42" - 53", 4 lights: 54" - 66").