

KI-215-SMA-II

TRAPEZOIDAL DUAL 15" SUBWOOFER



KLIPSCH PROFESSIONAL | PERMANENT INSTALLATION | DATA SHEET



PRODUCT OVERVIEW

The KI-215-SMA-II trapezoidal array-capable (sixteen built-in 3/8" 16-thread fly points) subwoofer perfectly complements Klipsch's high power full-range loudspeaker systems. The KI-215-SMA-II's enclosure dimensions and rigging configuration are identical to the KI-362-SMA-II full-range professional loudspeaker system, making it an ideal match when using an external, active two-way crossover. Its highest-quality heavy-duty drive components use 104-ounce magnets and 3" voice coils as well as proprietary speaker motor assemblies to deliver high sensitivity and advanced power handling capabilities.

Ideal for clubs, theaters, auditoriums, churches, and performance halls the plywood construction tuned port enclosure applies CNC fabrication techniques for uniform tolerances and build reliability.

FEATURES

- Dual 15" (38.1cm) cast frame transducers with 3" voice coils
- 130 dB SPL maximum output
- 22.5° symmetrical trapezoidal design makes it an ideal music reinforcement match with the KI-396, KI-262, and KI-272 when using an external, active crossover
- Low 40 Hz cabinet tuning allows electronic EQ to be added for extended response without undue component stress
- 16 suspension points for flexible mounting and rigging bar compatibility
- Available in Black, White or Raw Birch finish

APPLICATIONS

- Performing Spaces
- Auditoriums and Houses of Worship
- Bars and Music Clubs
- Small/medium Sports Facilities
- Theme Parks and Leisure Venues

DESIGNED AND MADE IN THE USA USING DOMESTIC AND IMPORTED COMPONENTS

In 1946, Paul W Klipsch, genius & maverick, hand-built his first loudspeaker in a tin shed with the intention of bringing live music into his living room. Remember great sound? We do, too. Today, Klipsch's KI series speaker enclosures are made in the USA, by proud craftsmen in Hope, Arkansas. Just like PWK intended.

SPECIFICATIONS

FREQUENCY RESPONSE¹ (+/- 3 dB)	70 Hz - 2.4 kHz (-10 dB @ 53 Hz)
POWER HANDLING²	800 watts (53V) 3200 watts peak
MAXIMUM SPL³	130 dB Continuous 136 dB Peak
SENSITIVITY⁴	105 dB
NOMINAL IMPEDANCE	8 ohms, minimum 3.5 ohms @ 42 Hz
COMPONENTS	Two K-45-ST 15" woofers
INPUT CONNECTION	Two point barrier strip
MOUNTING OPTION	Sixteen 3/8"-16 flypoints
BRACKET MOUNT	One attachment point for C-bracket Top and Bottom: 3/8"-16
ENCLOSURE MATERIAL	3/4" 7-ply birch plywood cabinet 1" MDF motorboard
HEIGHT	34.3" (87.12cm)
WIDTH	19.8" (50.29cm) front 6.8" (17.27cm) rear
DEPTH	16" (40.64cm)
WEIGHT	81 lbs. (36.82kg)
FINISHES	Black, White and Raw Birch finish

WITH TWO KI-362-SMA-IIs



¹ 3M, Half-spaced anechoic
² AES standard, continuous pink noise, 6 dB peaks
³ Calculated at 1M half-spaced at power handling power input
⁴ SPL at 1M, half-spaced anechoic with 2.83V input

KI-215-SMA-II

TRAPEZOIDAL DUAL 15" SUBWOOFER



KLIPSCH PROFESSIONAL | PERMANENT INSTALLATION | DATA SHEET

FREQUENCY RESPONSE

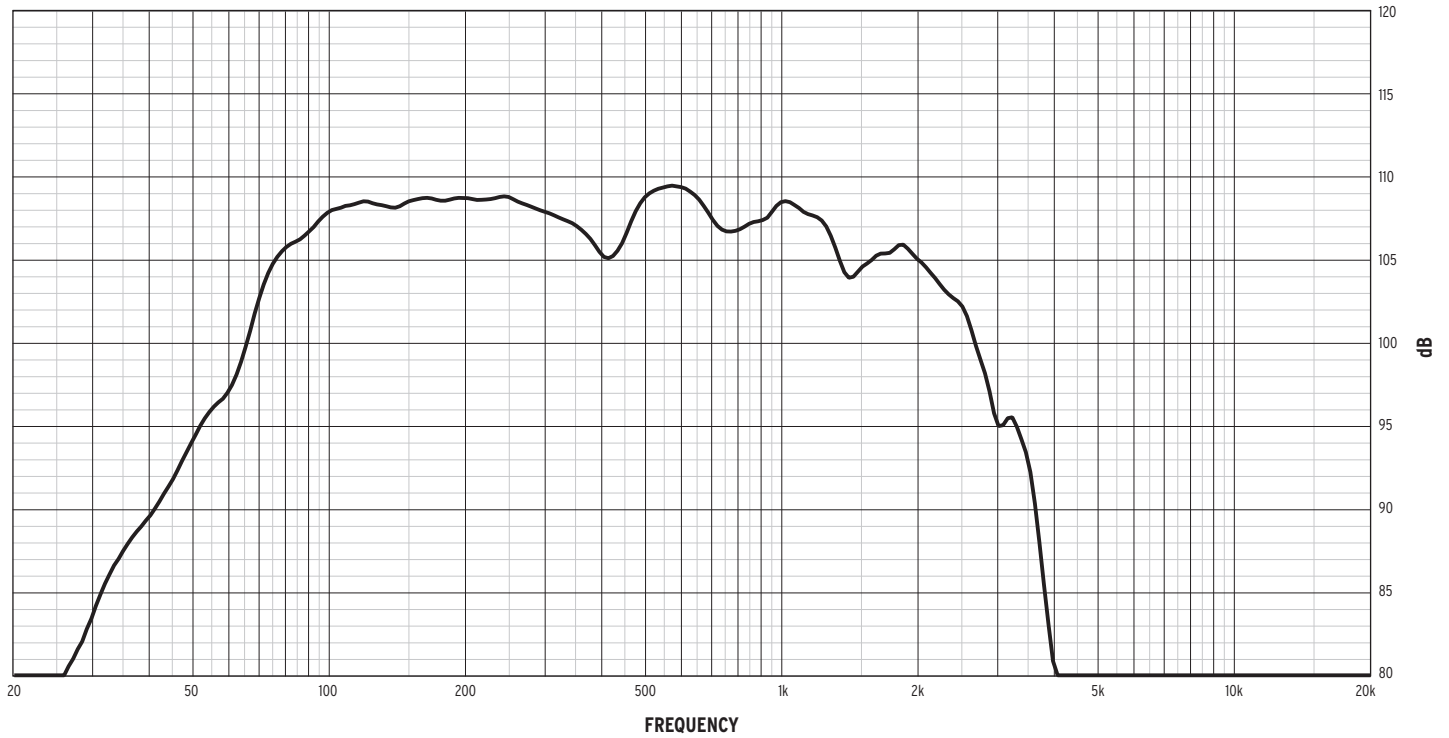

IMPEDANCE

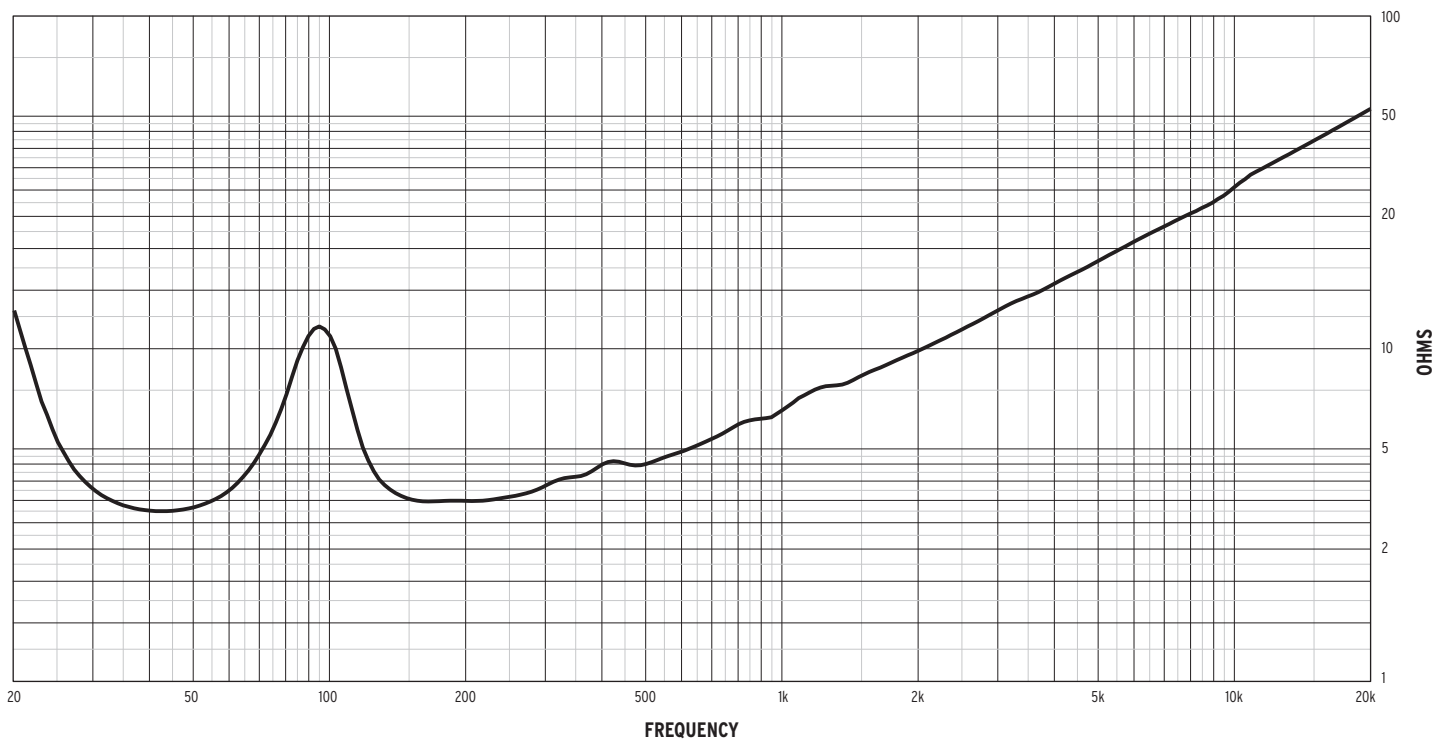

KI-215-SMA-II

TRAPEZOIDAL DUAL 15" SUBWOOFER



KLIPSCH PROFESSIONAL | PERMANENT INSTALLATION | DATA SHEET

HORIZONTAL OFF AXIS TRANSFER FUNCTION

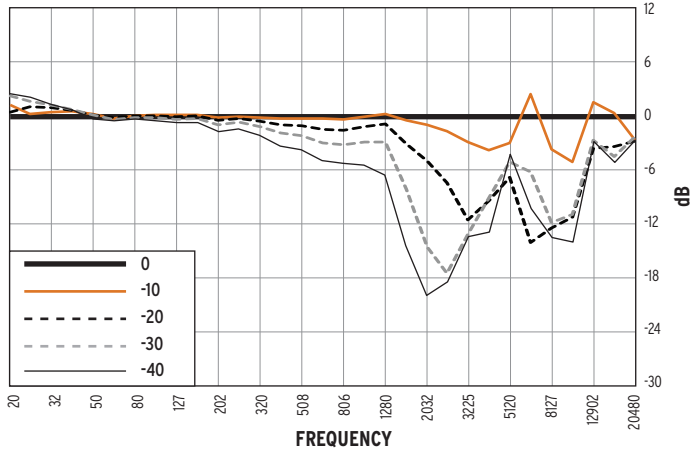

HORIZONTAL COVERAGE (-6dB)

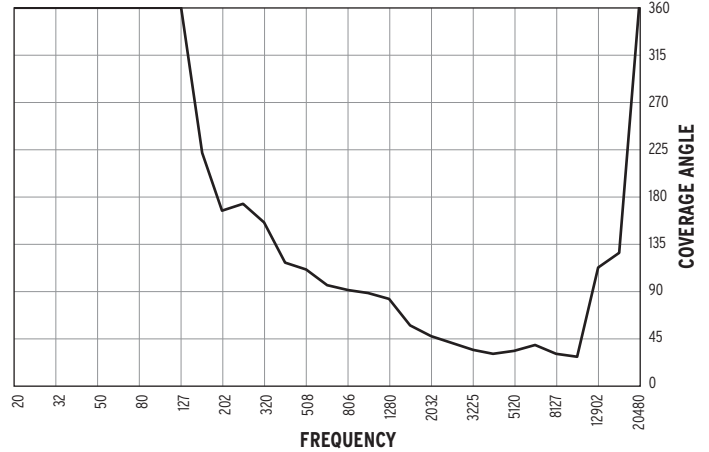

VERTICAL OFF AXIS TRANSFER FUNCTION

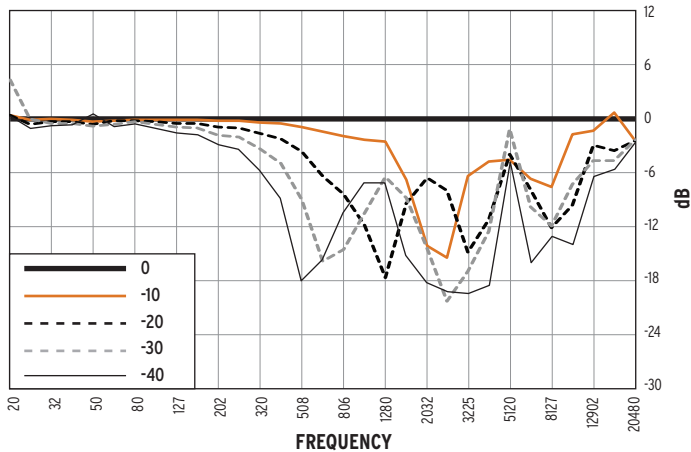

VERTICAL COVERAGE (-6dB)

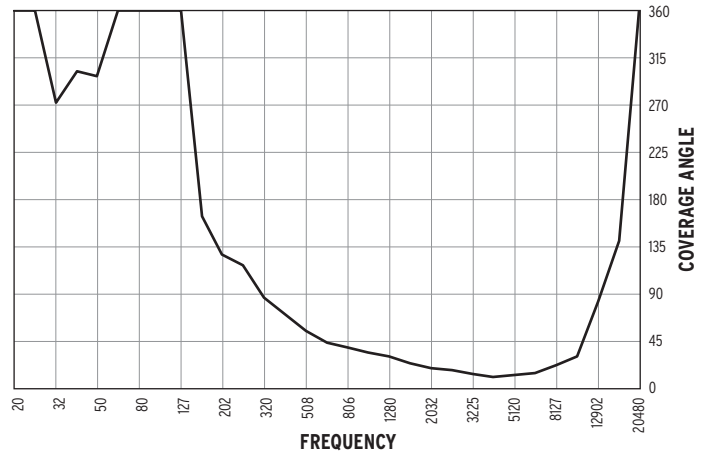

DIRECTIVITY INDEX

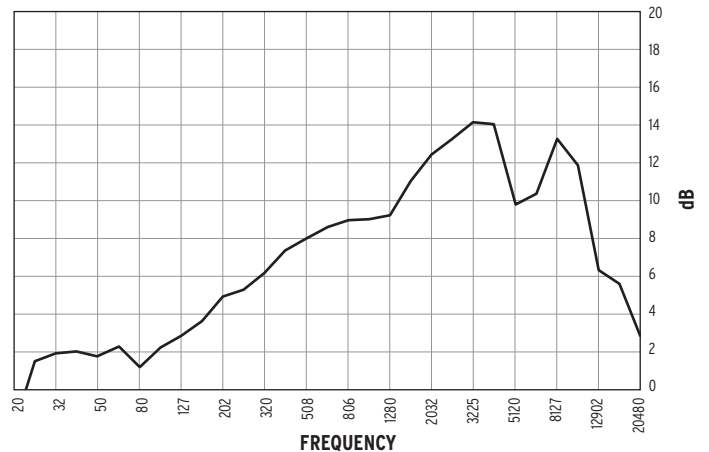

KI-215-SMA-II

TRAPEZOIDAL DUAL 15" SUBWOOFER



KLIPSCH PROFESSIONAL | PERMANENT INSTALLATION | DATA SHEET

HORIZONTAL 1/3 OCTAVE POLARS

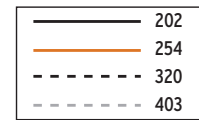
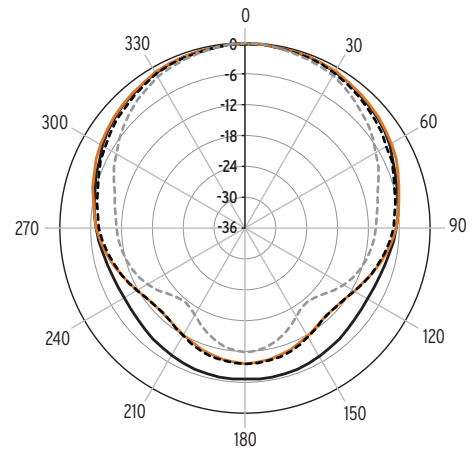
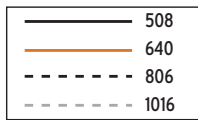
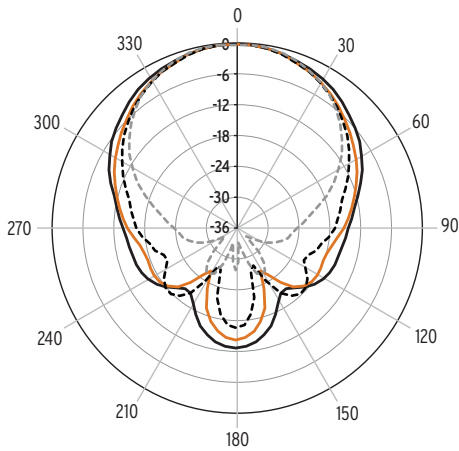
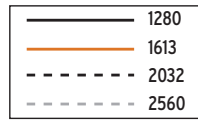
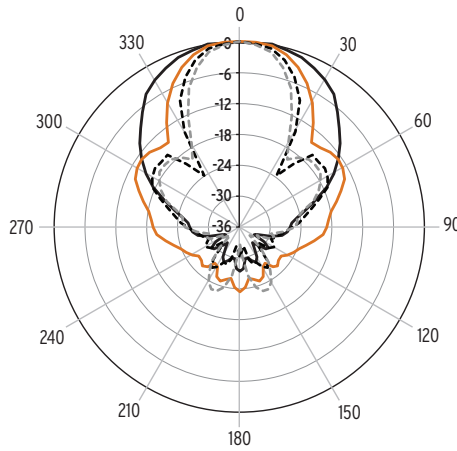

KI-215-SMA-II

TRAPEZOIDAL DUAL 15" SUBWOOFER



KLIPSCH PROFESSIONAL | PERMANENT INSTALLATION | DATA SHEET

VERTICAL 1/3 OCTAVE POLARS

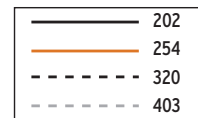
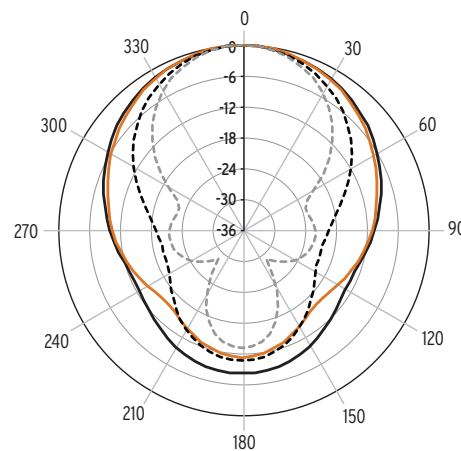
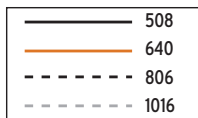
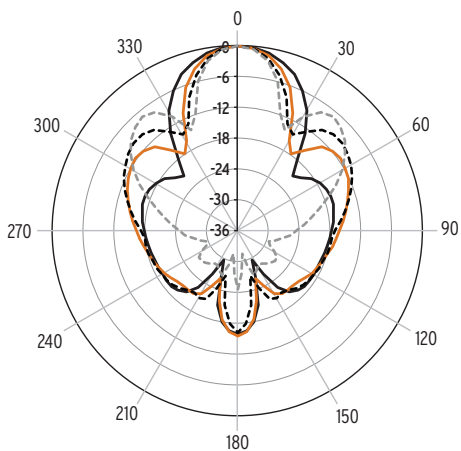
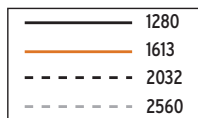
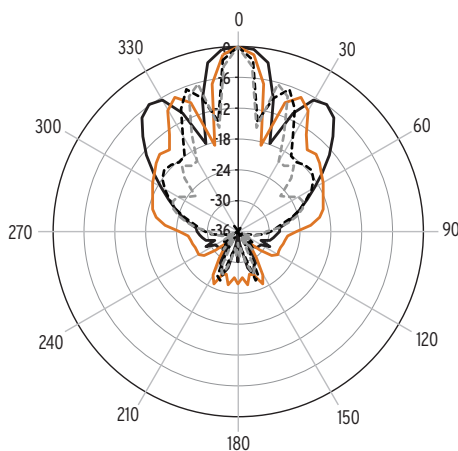

KI-215-SMA-II

TRAPEZOIDAL DUAL 15" SUBWOOFER



KLIPSCH PROFESSIONAL | PERMANENT INSTALLATION | DATA SHEET

ARCHITECTURAL SPECIFICATIONS

The KI-215-II-SMA high power dual 15" trapezoidal low frequency loudspeaker system shall include two 15" (381mm) K-45-ST low-frequency transducer each utilizing 3" (76.2mm) voice coil, and 104-ounce (2.95kg) motor magnet assembly. The enclosure tuning shall be of a vented design.

Frequency response shall be 70Hz to 2.4kHz, +/- 3dB, with the -10dB point at 53Hz, measured at three meters, half-space anechoic. Cabinet tuning shall be 40Hz, allowing electronic equalization for frequency extension. Refer to graphs for horizontal and vertical dispersion angles and directivity. Sensitivity shall be 105db SPL, measured at one meter, half space anechoic, with a 2.83v input. Power handling shall be 800 watts (53volts), to AES standards, continuous pink noise, 40Hz to 400Hz, 6db peaks. Calculated maximum continuous output at one meter shall be 130dB SPL. Nominal impedance shall be 8 ohms, with 3.5 ohms minimum at 42Hz. Signal connections shall be made via a two-point barrier strip.

The enclosure panels shall be CNC-fabricated, 3/4" 7-ply birch plywood, assembled using rabbet and dado joinery. The motorboard baffle shall be 1" (2.54cm) medium density fiberboard. Dimensions for the enclosure shall be 34.3" (87.12cm) high by 16.0" (40.64cm) deep by 19.8" (50.29cm) front width and 6.8" (17.27cm) rear width in a symmetrical trapezoidal shape, with both side panels angled at 22.5°. Net weight shall be 81lbs. (36.82kg). The enclosed will have a straight metal perforated grille for structural integrity and protection of the transducers from impact and tampering. Enclosure flying capability shall be provided via sixteen internal 3/8" 16-thread mounting points, four per top, bottom and both sides. Enclosure bracket mounting is provided with one 3/8"-16 threaded mounted point on top and bottom.

The enclosure shall be coated with lacquer-based primer and lacquer-based texture, with a black or white finish. The enclosure shall also be available unfinished in raw birch.

The system shall be a Klipsch KI-215-SMA-II loudspeaker.

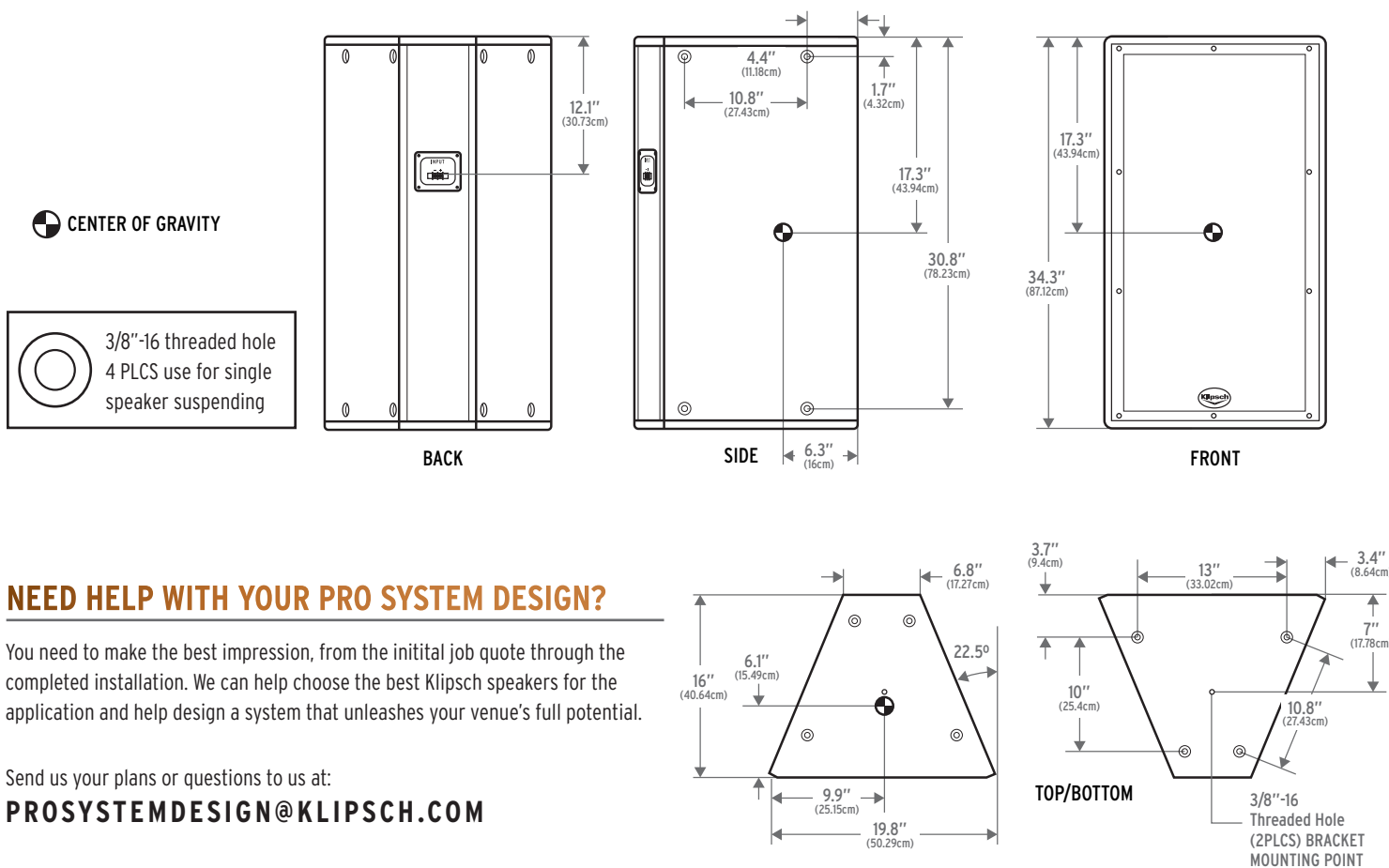

NEED HELP WITH YOUR PRO SYSTEM DESIGN?

You need to make the best impression, from the initial job quote through the completed installation. We can help choose the best Klipsch speakers for the application and help design a system that unleashes your venue's full potential.

Send us your plans or questions to us at:

PROSYSTEMDESIGN@KLIPSCH.COM

KI-215-SMA-II

TRAPEZOIDAL DUAL 15" SUBWOOFER



KLIPSCH PROFESSIONAL | PERMANENT INSTALLATION | DATA SHEET

ORDERING INFORMATION

KI-215-SMA-II

PART NUMBER	MODEL NAME	FINISH	PACKED QUANTITY	DESCRIPTION	UPC
1062014	KI-215-B-SMA-II	Black	1	Standard 8 ohm speaker	743878027969
1062015	KI-215-W-SMA-II	White	1	Standard 8 ohm speaker	743878029215
1062017	KI-215-R-SMA-II	Raw Birch	1	Standard 8 ohm speaker	743878029208

KI-215-SMA-II CARTON DIMENSIONS

HEIGHT	37" (94.0 cm)
WIDTH	22" (55.8 cm)
DEPTH	18.9" (48.0 cm)