

### Model Number: M58PSLD

Special Notes: LED GU10 lighting. M600 and M1200 blowers are sold separately. Features stainless steel baffle filters.

<b>WIDTH:</b>	58 3/8"
<b>DEPTH:</b>	22 1/2"
<b>HEIGHT:</b>	12 1/2"
<b>CFM:</b>	(Chart A)
<b>SONES:</b>	N/A
<b>AMPS:</b>	(Chart B)
<b># LIGHTS:</b>	4

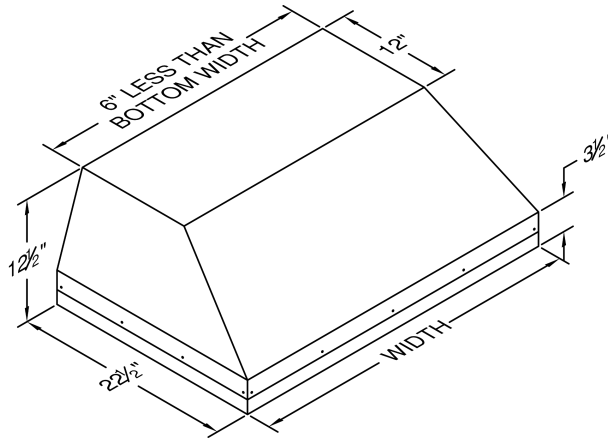

### CONNECTION DIAGRAM

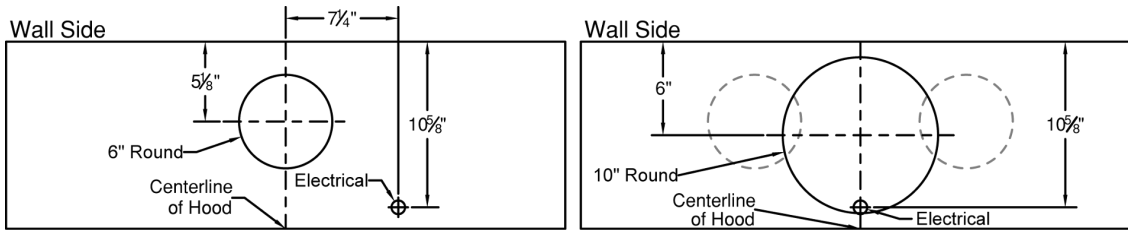

M600 & M1200 Connection Diagrams

### REC. MOUNTING HEIGHT\*

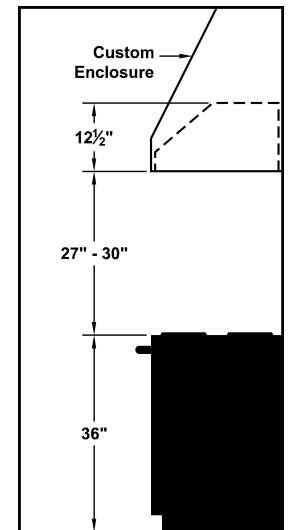

\* Exceeding recommended mounting height may compromise performance.

### VP566 Transition Details (Included with M1200)

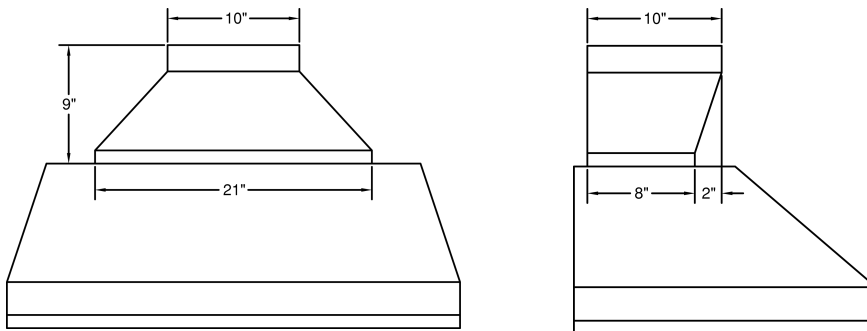

(Front View)

(Side View)

### (CHART B)

SPEED	CFM @ 0.1" S.P.		
	M600	WHM300 *	M1200
1	240	240	420
2	300	300	645
3	500	-	865
4	625	-	1015

\* The WHM300 is a wiring harness that when used with the M600 blower (sold separately) will disable blower speeds exceeding 300 CFM.

### (CHART A) ELECTRICAL/MECHANICAL SPECIFICATIONS FOR BLOWER UNIT

MODEL	VOLTS	AMPS+	HZ	CFM SP@0.0"	CFM SP@0.1"	CFM SP@0.25"	CFM SP@0.5"	CFM SP@0.75"	MIN. ROUND DUCT SIZE
M600 Single	115	5.0	60	630	625	615	600	580	6" (28in. <sup>^2</sup> )
M600 w/WHM300 Harness	115	5.0	60	302	300	295	288	278	6" (28in. <sup>^2</sup> )
M1200 Dual	115	10.0	60	1035	1015	1000	995	915	10" (79in. <sup>^2</sup> )

+Add 0.5 amp for each halogen light. Hoods are available with halogen lights (2 lights: 30" - 41", 3 lights: 42" - 53", 4 lights: 54" - 66").