

SONY[®]

Wireless Speaker

Operating Instructions

SRS-RA5000



Table of contents

What's in the box	3
Part names	4
Set up the speaker	7
Play music	
Play music using a Chromecast-enabled app	10
Play music by talking to an Alexa Built-in device	12
Play 360 Reality Audio music	15
Play music via a BLUETOOTH® connection	16
Others	18

Help Guide (Web document for a PC/smartphone)

The "Help Guide" describes the features of the speaker, how to use the speaker in detail, and how to troubleshoot.



http://rd1.sony.net/help/ha/srsra5000/h_zz/

What's in the box

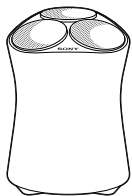

Wireless Speaker (1)

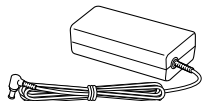

AC adapter (1)

Models for Middle East



AC power cord (1)

Models for Europe and Russia



AC power cord (2)



Models for other countries/regions



AC power cord (1)*

* The shape of the AC power cord varies depending on the country or region.



Operating Instructions
(this document) (1)



Precautions/Specifications (1)

Part names

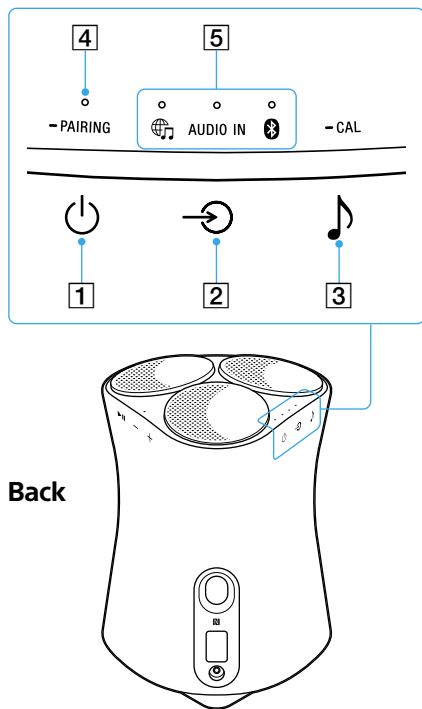

Back

1 (Power)/ PAIRING button

- Touch to turn the power on/off.
- Touch and hold for more than 2 seconds to put the speaker in BLUETOOTH pairing mode.

2 (Input) button



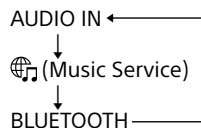

Touch to select the input. Each time you touch the button, the input changes cyclically as follows:









3 (Sound Mode)/ CAL (Sound Calibration) button

- Touch to turn the Immersive Audio Enhancement on/off (page 19).
- Touch and hold for more than 2 seconds to start the Sound Calibration. To cancel the Sound Calibration, touch the button again.

4 Power indicator

-  (Green): Power on
-  (Amber): BLUETOOTH/Network Standby
-  (Turns off): Power off
-  (Red): The speaker is in protect mode. Refer to “Troubleshooting” in the Help Guide.

5 Input LED indicators

- | | |
|---|--|
|  |  (White): Wi-Fi network input is selected. |
| (Music Service) |  (Green): The speaker connects to a music service through input from the Wi-Fi network. |
| AUDIO IN |  (White): Audio input is selected. |
|  |  (Blue): BLUETOOTH input is selected. |
| (BLUETOOTH) |  (Blue): The speaker is in BLUETOOTH pairing mode. |

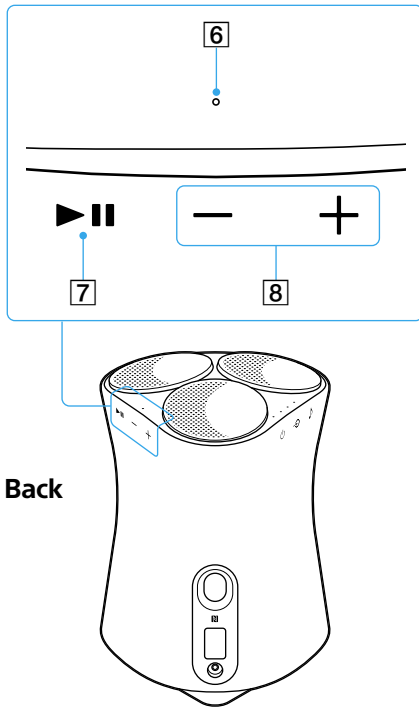

6 Reaction indicator

☀️ (Green):

Flashes in response to the ▶️⏸️ (Play/Pause) button and — (Volume -) button / + (Volume +) button operations.

The indicator rapidly flashes 3 times when you reach the maximum or minimum volume.

7 ▶️⏸️ (Play/Pause) button

- Touch 1 time to play or pause music.
- Touch 2 times to go to the next song.
- Touch 3 times to go back to the previous song.
- Touch and hold for more than 2 seconds to play back the 360 Reality Audio sample music. To stop playback, touch the button again.

8 — / + (Volume -/+) buttons

Part names

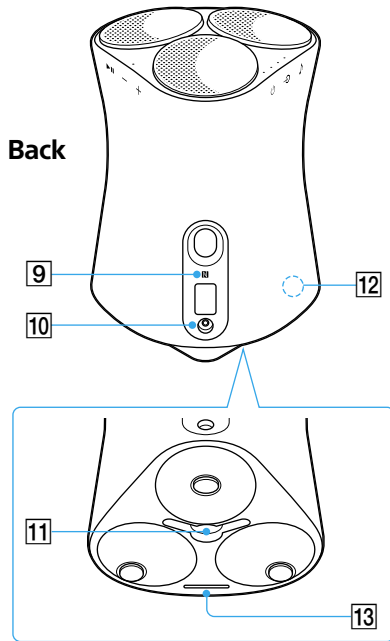

9 N-Mark

Hold an NFC-compatible device over the mark to establish a BLUETOOTH connection.

10 AUDIO IN jack

Use an analog audio cable to connect an audio device.

11 DC IN jack (page 8)

12 LINK indicator

● (Amber): A Wi-Fi connection is established.

13 Sound Mode indicator

- (Cyan): 360 Reality Audio is being played back.
- (White): The Immersive Audio Enhancement is on.
- (Turns off): The Immersive Audio Enhancement is off.

Set up the speaker

- 1 When carrying the speaker, hold the bottom of the speaker with both hands and place the speaker where you are going to use it.

Set the speaker down with the logo of Sony facing the front.

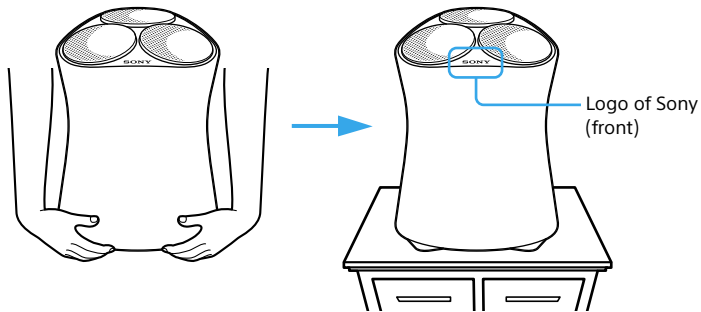

When handling the speaker, note the following points.

Do not touch the buttons accidentally.

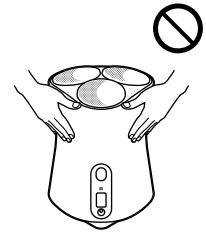



Do not put pressure on the speaker grill.

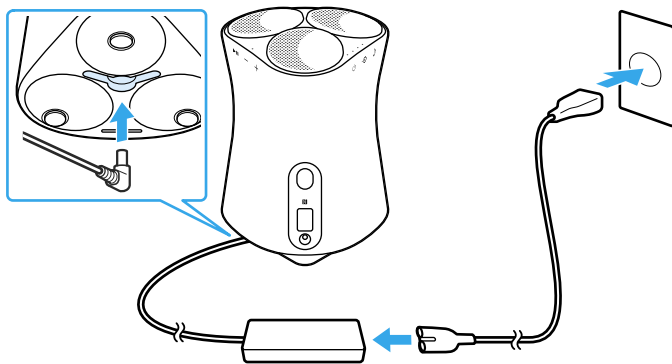

Set up the speaker

- 2 Connect the AC power cord to the AC adapter, and then plug it into an outlet.



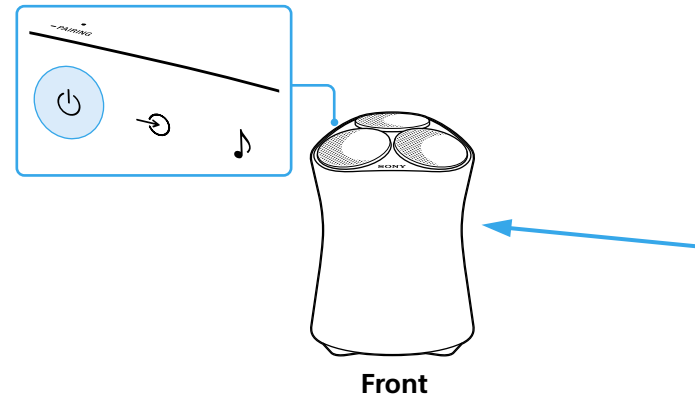

- 3 Touch the  (Power)/  PAIRING button to turn on the speaker, and then keep over 1 m (3.3 feet) away from it.

When you turn on the speaker for the first time, the Sound Calibration automatically starts. The speaker beeps to adjust to the proper sound balance for your room.



Tip

If you want to redo the Sound Calibration, touch and hold the  (Sound Mode)/  CAL (Sound Calibration) button for more than 2 seconds.

4 Touch and hold the  (Play/Pause) button for more than 2 seconds.

The 360 Reality Audio sample music plays back.

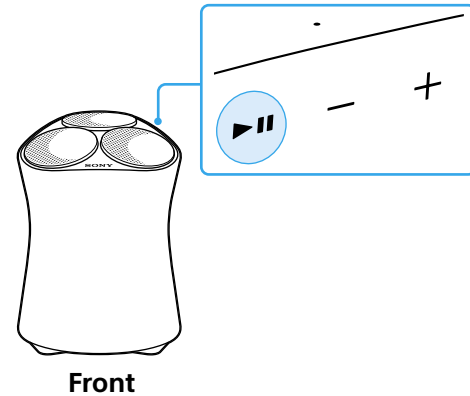
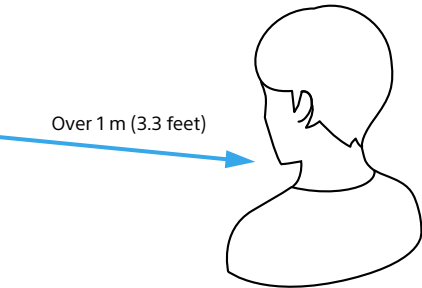

Play music

Play music using a Chromecast-enabled app

This speaker comes with Chromecast built-in™*. By using a Chromecast-enabled app, you can stream music you select on your mobile device to the speaker. For more information about Chromecast-enabled apps, visit the support page for Google.

* Services may not be available, depending on your country or region.

1 Install the Google Home app on your smartphone.

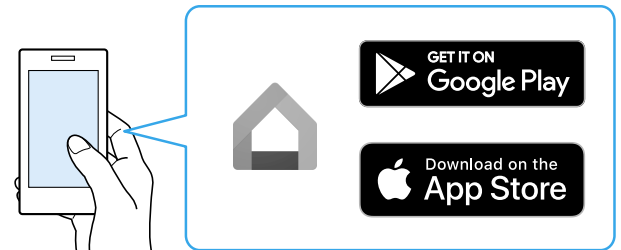

2 Follow the Google Home app's on-screen instructions to connect your speaker to the same Wi-Fi network as your smartphone.



3 Tap  (cast) in your favorite streaming service to start streaming music to the speaker.

For playing back 360 Reality Audio music, see "Play 360 Reality Audio music" (page 15).

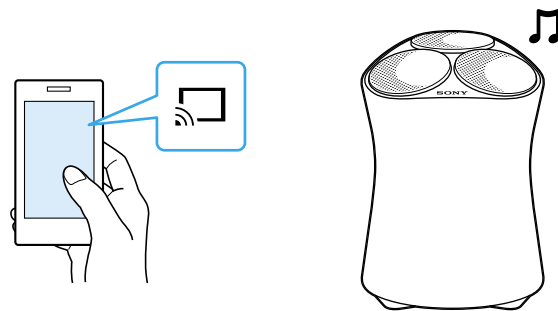

By talking to an Alexa Built-in device, you can stream music to the speaker from a streaming service that supports Alexa.

Note

- Before operating the speaker, connect the Alexa Built-in device to the same Wi-Fi network as your smartphone and complete the initial setup.
- Alexa Voice Service is not available in all languages and countries/regions.
- The design of the app may change without notice.

1 Install “Sony | Music Center” on your smartphone.

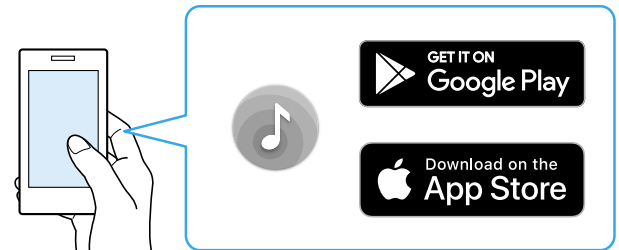

2 Select your speaker on the screen in "Sony | Music Center."



3 Follow the on-screen instructions in "Sony | Music Center" to connect your speaker to the same Wi-Fi network as your smartphone.



4 Follow the on-screen instructions to do the settings for operating the speaker with Alexa.

If the settings screen for Amazon Alexa does not appear, select [Settings] - [Amazon Alexa] - [Initial Setup] on the screen on which you selected the speaker.

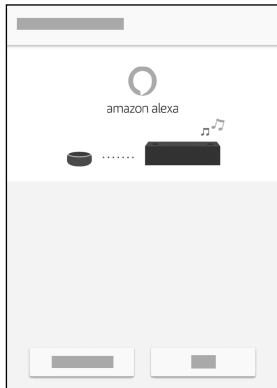

5 Talk to Alexa to play music.

For playing back 360 Reality Audio music, see “Play 360 Reality Audio music” (page 15).

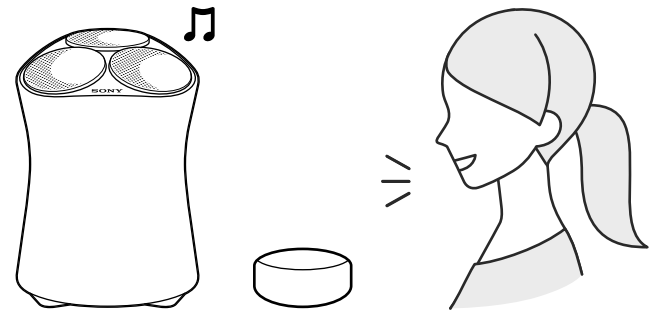

A Wi-Fi network connection is required to play 360 Reality Audio music. Music cannot be played back via a BLUETOOTH connection.

- 1** Follow the procedure in “Play music using a Chromecast-enabled app” (pages 10 to 11) or “Play music by talking to an Alexa Built-in device” (pages 12 to 14) and connect the speaker to a Wi-Fi network to enable music playback.
- 2** Install a streaming service app* that provides 360 Reality Audio on your smartphone.
- 3** Use the app you installed in step 2 to cast (play) the music you want to play to the speaker.

* You can see the streaming services that provide 360 Reality Audio in “Sony | Music Center.” Services may not be available, depending on your country or region.

1 Turn on your smartphone's BLUETOOTH function.

Note

360 Reality Audio cannot be played back via a BLUETOOTH connection. See "Play 360 Reality Audio music" (page 15).

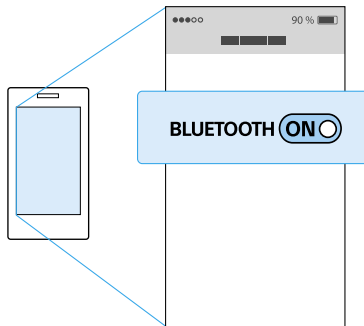

2 Touch and hold the speaker's ⏻ (Power)/
- PAIRING button for more than 2 seconds to enter the BLUETOOTH pairing mode.
The BLUETOOTH indicator flashes.

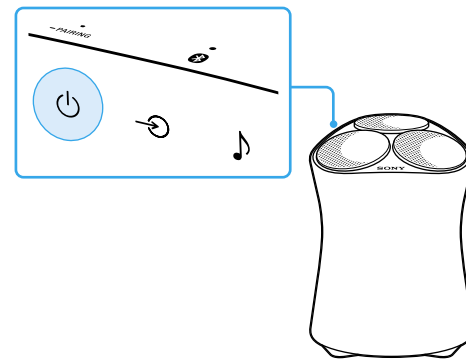

3 Search for the speaker on your smartphone, and then tap either [SRS-RA5000] or the name you gave the speaker to connect to the Wi-Fi network.

Wait until the BLUETOOTH indicator stops flashing and remains lit.

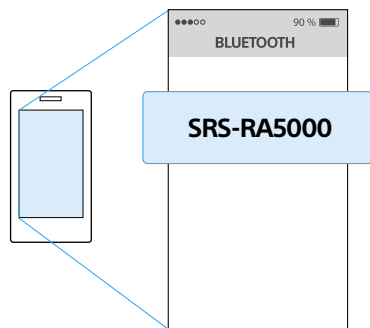

4 Play music using a music playback app on your smartphone.

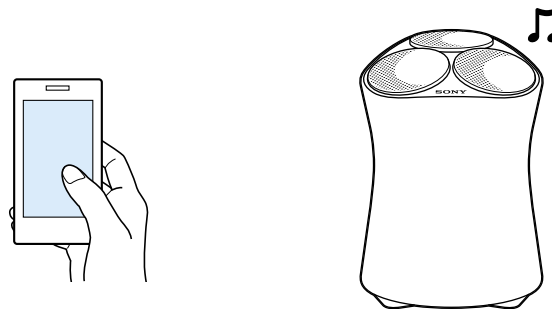

Others

You can change the functions' settings by touching the various buttons on the speaker.

Functions	How to operate
The speaker's settings can be returned to their default.	Touch and hold the ► (Play/Pause) button and the — (Volume -) button simultaneously for more than 4 seconds. The BLUETOOTH indicator (blue), the 🎵 (Music Service) indicator (white), and the AUDIO IN indicator (white) light at the same time when the speaker is initialized.
The BLUETOOTH/Wi-Fi network can be set to on or off.	Touch and hold the ► (Play/Pause) button and the + (Volume +) button simultaneously for more than 4 seconds. The BLUETOOTH indicator (blue) and the 🎵 (Music Service) indicator (white) flash when the setting changes. <ul style="list-style-type: none"> • Set to on: slowly flash 2 times • Set to off: quickly flash 10 times
The BLUETOOTH/Network Standby function can be set to on or off.	Touch and hold the ⏻ (Power)/ PAIRING button and the 🎵 (Sound Mode) button simultaneously for more than 4 seconds. The speaker automatically turns off when the setting changes. <ul style="list-style-type: none"> • Set to on: the Power indicator (amber) lights when the speaker is off • Set to off: the Power indicator turns off when the speaker is off
The Auto Standby function can be set to on or off.	Touch and hold the ↻ (Input) button and the + (Volume +) button simultaneously for more than 4 seconds. The Power indicator (green) flashes when the setting changes. <ul style="list-style-type: none"> • Set to on: flashes 2 times • Set to off: flashes 3 times
The System Sound can be set to on or off.	Touch and hold the 🎵 (Sound Mode) button and the — (Volume -) button simultaneously for more than 4 seconds. This changes the System Sound between enabled and disabled.

What is the Immersive Audio Enhancement?

The Immersive Audio Enhancement is a sound mode that allows you to experience the music of typical 2-channel playback in a three-dimensional sound field.



Information about 360 Reality Audio
URL: www.sony.net/360RA/

4-745-177-13(1)

