

Model Number: CIEH9-2+266

Special Notes: LED lights. This model is not available with heat lamps. Shown with optional duct covers (sold separately). Optional duct covers are available in standard and custom sizes.

WIDTH:	66"
DEPTH:	27"
HEIGHT:	9"
CFM:	1100
SONES:	6.0
AMPS:	7.5
# LIGHTS:	6

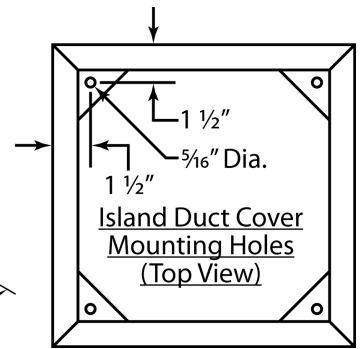
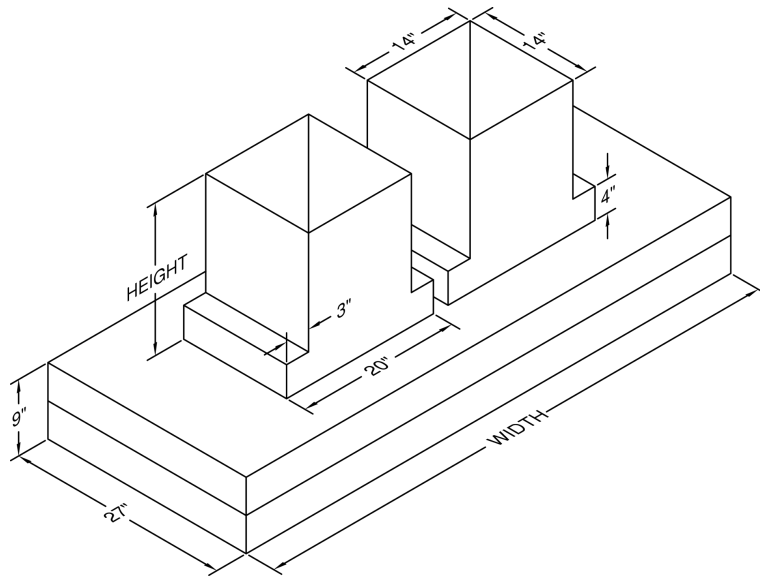

CONNECTION DIAGRAM

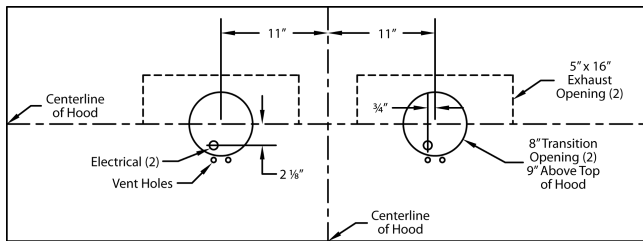

REC. MOUNTING HEIGHT*

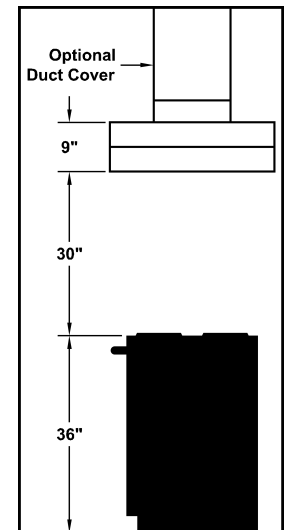

* Exceeding recommended mounting height may compromise performance.

1100 CFM T2+200 Dual Blowers (Top View)

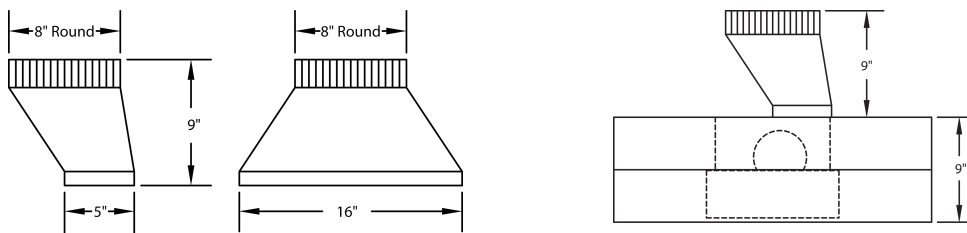

VP565 Standard Transition
(Two Included)

Transition Installed
(Side View)

ELECTRICAL/MECHANICAL SPECIFICATIONS FOR BLOWER UNIT

MODEL	VOLTS	AMPS+	HZ	RPM	CFM SP@0.0"	EQUIV CFM\$	CFM SP@0.1"	CFM SP@0.2"	CFM SP@0.3"	MIN. ROUND DUCT SIZE	SONES#
Two T200 Island Duals	115	7.5	60	1550	1100	1800	1014	942	862	Two 8" (50 sq. in.)	6.0

+ This model is equipped with LED lighting (6 lights: 60" - 66").

\$ Because the Magic Lung blower uses centrifugal filtration rather than conventional baffle or mesh filters, the Magic Lung blower can handle cooking equipment with higher cubic feet per minute (CFM) requirements and can deliver equivalent CFM much more efficiently than other filtration systems. When comparing the Magic Lung with other blower units made by other manufacturers, use the "Equivalent CFM".

Ratings in accordance with the Standard Test Code by the Energy Systems Laboratory of the Texas Engineering Experiment Station.