

234D2437P044 Rev.0

- Motor 120V-60HZ WW02A00226
- Drive Belt WW02F00028
- Idle Pulley WW03F00350
- Shaft & Bracket Asm. WW02A00019

SERVICE NOTE: Some replacement parts may have more terminal connections than the original part. Wire the new part to the some numbered terminals as the original part and disregard the unused terminals unless a special instruction is provided.

AIR FLOW AND SEALS

Proper air flow through the dryer is essential for normal operation of the temperature control and safety systems. Air is **PULLED** into the cabinet from rear and drawn up across the heaters located behind the drum. This hot air is **PULLED** through the drum rear, across the clothes load, through the lint trap and down the trap duct into the blower. From the blower the air is **PUSHED** out of the exhaust system. Any air leaks between the air inlet and the blower, such as lower drum front left or trap duct to cabinet front sealing, will result in improper temperatures. The air being pulled down the trap duct to the drum outlet thermostat will be cooler than normal giving this thermostat a false indication (delayed or no-trip). Leaks ahead of the blower will also reduce the volume of air across the heaters causing hot spots and possible premature failure.

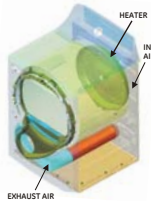

TRAP DUCT SEALING

To inspect the trap duct for proper sealing, remove the lint filter and look down into the duct. With a light examine the trap duct on all sides where it meets the drum front for voids in sealing. Leaks may be sealed with permatex.

- WHEN FLEXIBLE DUCT IS USED, WE STRONGLY RECOMMEND METALLIC FLEXIBLE DUCT.
- EXHAUST DUCT MUST BE 100mm (4 INCH) DIAMETER
- FOR SPECIFIC EXHAUST SPECIFICATION, REFER TO INSTALLATION INSTRUCTIONS SUPPLIED WITH THE DRYER.

DRIVE BELT

The drum is rotated counterclockwise, as viewed from the front, at a speed of 47-51 RPM. Belt tension is maintained by a spring-loaded idler pulley and driven by a pulley attached to the rear motor shaft.

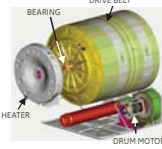

STEAM SYSTEM (on some models)

Water is injected in the drum through a nozzle located at the front of the appliance. A water valve located at the bottom rear of the dryer provides water to nozzle. When servicing nozzle check for leaks and replace if necessary.

IMPORTANT - Reconnect the steam supply hose coupling on models so equipped.

DISASSEMBLY

Step 1: Remove the two hex head screws from the top rear corners of the control panel.

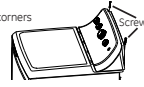

Step 2: Grasp the control panel sides, push it back, and roll it up and off. Carefully lay it on its face on the top cover.



Step 3: Remove the five screws from the control panel cover.

Disconnect the connectors from the control board and set the control panel aside.

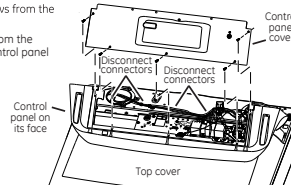

Step 4: Remove the screws/rear cover plates from the top cover. Remove the ground wire screw from the back right corner opening.

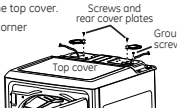

Step 5: Remove the two phillips head screws from the back corners of the top cover.

Open the dryer door and remove the two screws from the front underside of the top cover.

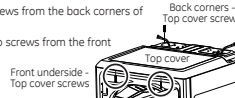

Step 6: Grasp the front corners of the top cover, lift up, slide back and lift up. Hold the top cover with one hand, push the wiring harness through the openings and then set the top cover aside.

NOTE: To remove the front panel, remove the two screws from the top front panel corners, and disconnect all of the connectors and the water line. Set the front panel aside.

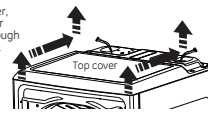

NOTES:

1. Heater element is shown on wiring schematic (on reverse side of this sheet). Check for infinite resistance between any heater terminal and dry cabinet. Heater failure could result from low air flow caused by improper sealing, kinked or excessive ducting or excessive line voltage.
2. Other factors contributing to long dry times, or clothes condition: load size, large bulky items, ambient temperature, room size (if not exhausted outdoor), washer spin speed, washer rinse temperature, gas supply (restrictions), gas pressure.
3. Small loads: Less than 3 lbs. If not treated with destatizer could develop a static charge if over dried and cling to drum surface (no tumble) causing wrinkles, shrinkage, or melting. Use a fabric softener (washer or dryer) or add 2 large bath towels to act as a buffer when drying.

234D2437P044 Rev.0

234D2437P044 Rev.0

PUB NO. 29-6381 02-21



WARNING Electrical Shock Hazard

Death or serious injury can result from failure to follow these instructions.

- Service by a qualified service technician only.
- Disconnect power before servicing this product.
- Reconnect all grounding devices after service.
- Replace all parts and panels before operating.

AVERTISSEMENT Risque de choc électrique

Vous pouvez être tué ou gravement blessé si vous ne suivez pas ces instructions.

- Réparations seulement par un technicien qualifié.
- Débranchez l'alimentation électrique avant la réparation.
- Rebranchez tous les dispositifs de mise à la terre après la réparation.
- Remettez toutes les pièces et panneaux en place avant d'utiliser l'appareil.

ADVERTENCIA Riesgo de Descarga Eléctrica

Usted puede morir o sufrir lesiones graves si no siguen estas instrucciones.

- El servicio técnico sólo debe ser realizado por un técnico calificado.
- Desconecte el suministro de corriente antes de realizar el servicio técnico.
- Luego del servicio técnico, vuelva a conectar todos los dispositivos de conexión a tierra.
- Reemplace todas las piezas y paneles antes de utilizar.

234D2437P044 Rev.0

DANGER: DISCONNECT ELECTRIC POWER SUPPLY BEFORE SERVICING

CAUTION: LABEL ALL WIRES PRIOR TO DISCONNECTION WHEN SERVICING CONTROLS. WIRING ERRORS CAN CAUSE IMPROPER AND DANGEROUS OPERATION. VERIFY PROPER OPERATION AFTER SERVICING.

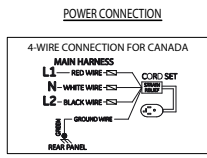
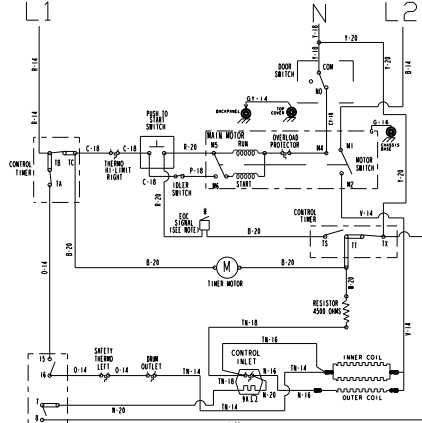

Electric Dryer

3 CYCLES CONTROL TIMER CAM CHART

360° = 180 MIN	AUTO	NORMAL THRESHOLD CYCLE	AUTO LONER CYCLE
A-B (HEATER)	ON	ON	ON
B-C (MOTOR)	ON	ON	ON
T-X (TIMER)	ON	ON	ON
T-S (SIGNAL)	ON	ON	ON

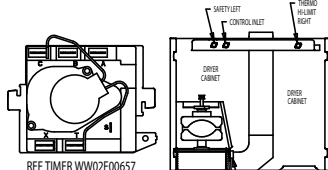

TIMER AND SWITCH CONTACT LEGEND

CONTACT LEGEND	SELECTOR SWITCH (SELECTIVE)	CONTACTS	PUSH TO START
INTERMITTENT	7-8	15-16	CONT.
CLOSED			
OPENED			
NOT AFFECTED			
MOMENTARY			

WINDINGS & COILS RESISTANCE VALUES

WINDINGS & COILS	START	WINDING VALUE	WINDING VALUE	WINDING VALUE
MAIN MOTOR	START	2.38-3.30	Ω	
	RUN	3.19-3.53	Ω	
HEATER COILS	INNER	20.71-22.89	Ω	
	OUTER	20.71-22.89	Ω	
TIMER MOTOR		3384-3816	Ω	

234D2288P027
REV. 12

PUB NO. 29-6381 02-21