

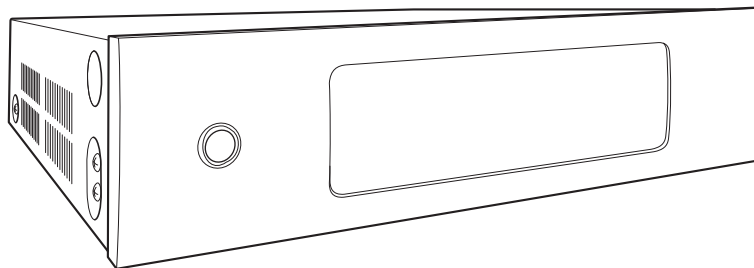

Owner's Manual

HEOS Drive HS2



Introduction	5	Adding more HEOS devices	21
Before your begin	6	Adding wired HEOS devices	21
System requirements	6	Adding wireless HEOS devices	22
Network requirements	6	Using your HEOS DRIVE	23
Controller requirements	7	Selecting a room	23
Getting to know your HEOS Drive	8	Listening to radio	24
Front panel	9	Playing music stored on your mobile device	24
Back panel	10	Playing music from your networked PC or NAS	25
Placing your HEOS Drive	11	Playing music from an external audio device	26
Attaching the rack mount brackets	12	Streaming an external audio device to any HEOS device	27
Mounting in a rack	12	Playing music from a USB device	28
Zone connection	13	HEOS account	29
Connecting speakers (4 stereo zones)	14	What is a HEOS account?	29
Connecting speakers	14	Why do I need a HEOS account?	29
Connecting speakers (two bridged zones)	15	Signing up for a HEOS account	29
Connecting to an external amplifier or AV receiver	16	Changing your HEOS account	29
Connecting a subwoofer	16	Playing from streaming music services	30
Connecting a USB storage device	17	Adding a music service	30
Trigger control	17	Changing music service settings	30
Connecting external devices (assignable)	18	Managing inputs	31
Connecting an audio playback device	18	Changing the name of the inputs	31
Connecting to network	19	Hiding an input	31
Powering your HEOS Drive	20	Managing your phone	32
Getting the HEOS app	20		

Listening to the same music in multiple rooms	33	Making adjustments	41
Grouping rooms	33	Changing the name of a HEOS Drive	41
Ungrouping rooms	34	Changing the name of a zone	41
Grouping all rooms (party mode)	35	Adjusting the equalizer	42
Ungrouping all rooms	36	Adjusting the balance	42
Using the now playing queue	37	Adjusting the output mode	42
Play Now	37	Adjusting the audio quality	42
Play Now & Replace Queue	37	Adjusting the volume limit	43
Play Next	37	Adjusting the preamp out	43
Add to End of Queue	37	Adjusting the high pass filter	43
Rearranging the now playing queue	38	Using a subwoofer	44
Deleting songs from the play queue	38	Adjusting the Low Pass Filter	44
Deleting all songs from the play queue	39	Adjusting the line out	44
Saving playlists	39	Adjusting the status light brightness	44
Performing repeat and shuffle playback	39	Advanced settings	45
Using the favorite	40	Network settings	45
Adding to HEOS favorite	40	Firmware upgrade	45
Deleting station from the HEOS favorite	40	About	46
		External device control	47
		IP control	47
		Trigger out	48



Updating your system	49	Status LED table	56
Advanced features	50	Supported file types and codecs	63
Sharing music from your mobile device	50	Supported audio formats (Coaxial/Optical)	63
Submit diagnostics	50	Specifications	64
Resetting your controller app	50	Information	67
Power management	51	Trademarks	67
Power modes	51	License	68
Quick Start Mode	51	License information for the software used in the unit	68
Deep Standby	51		
Off	51		
BASIC TROUBLESHOOTING	52		
My HEOS device turns off and the power LED flashes in red	52		
Music cuts out or delays sometimes	53		
I hear a delay when using the external input with my TV	53		
Resetting your HEOS device	54		
Restoring the HEOS device to factory defaults	54		
Contact Denon	55		



Thank you for purchasing this HEOS product. To ensure proper operation, please read this owner's manual carefully before using the product.

NOTE

- THIS DOCUMENT CONTAINS INFORMATION THAT IS SUBJECT TO CHANGE WITHOUT NOTICE.
For latest information, please visit <http://www.HEOSbyDenon.com>

Introduction

The HEOS Drive is part of the HEOS multi-room sound system that enables you to enjoy your favorite music anywhere and everywhere around your home. By utilizing your existing home network and the HEOS app on your iOS or Android™ device, you can explore, browse, and play music from your own music library or from many online streaming music services.

- True multi-room audio - play different songs in different rooms or the same song in every room
- Utilizes your existing home network for quick and easy setup
- Industry leading microsecond audio synchronization between HEOS device confirm microsecond sync with Drive
- Legendary Denon audio quality
- If you are in a hurry, you can be enjoying great sounding music in no time by following the steps outlined in the HEOS Quick Start Guide (packaged with your HEOS device).



Please continue reading this Owner's Manual for more detailed information about the features and benefits of your HEOS Drive.

Before your begin

NOTE

- If you have already installed at least one HEOS device, please skip to the section "Adding more HEOS devices" ( p. 21).

System requirements

Before you begin installing your first HEOS device, please make sure you understand and meet a few basic requirements.

■ Network requirements

Wireless Router - In order to use your HEOS music system, you must have a working wireless (Wi-Fi) or ethernet network in your home. Even when connected to an Ethernet network, a Wi-Fi connection to the router is required to control the system using the HEOS Control app. If you do not have a wireless network, please contact your local Denon dealer or electronics retailer to assist you with purchasing and installing a wireless network in your home.

High Speed Internet Connection - HEOS accesses the Internet to stream music to your home from many popular online music services. HEOS is also designed to provide you with software updates, which are delivered via your home Internet connection. DSL, Cable, and Fiber services will provide the best experience and reliability. You may experience performance issues with slower Internet connections like satellite based services.

■ Controller requirements

You can control your HEOS multi-room sound system using the free HEOS app on any iOS or Android mobile device that meets these minimum requirements:



iOS Minimum Requirements

- iOS version 7.0 or later
- iPhone® 4 or newer
- iPad® 2 or newer
- iPod touch® (5th generation) or newer



Android Minimum Requirements

- Android OS version 4.0 or later
- All resolutions

Getting to know your HEOS Drive

Unpack your HEOS Drive from the box and verify that the following items are included:

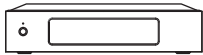

HEOS Drive



Ethernet cable

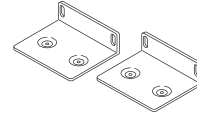

Rack mount brackets



Thank you note



Quick Start Guide



Safety Instructions



Warranty
(North America model only)



Extended Protection Plan
(North America model only)



(for North America)



(for Europe)



(for UK)



(for Australia)

Power cords

NOTE

- Please use the power cord included in the box for your device.

■ Front panel

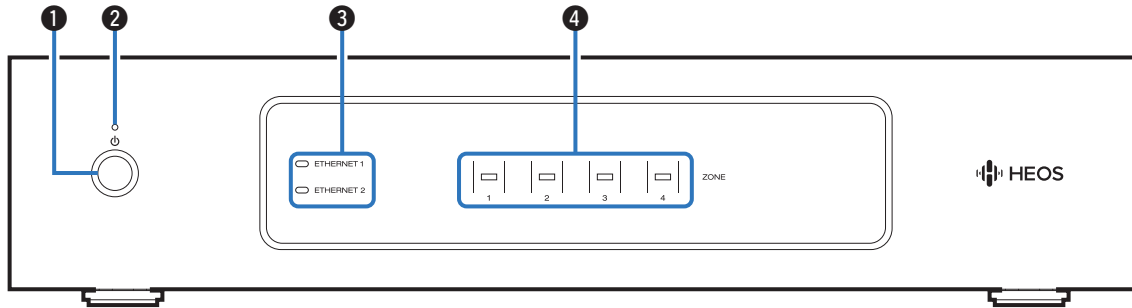

1 Power operation button (⏻)

Used to enter Quick Start Mode or Deep Standby and return from them.

2 Power indicator

This is lit as follows according to the power status: (👉 p. 56)

- White: Power on
- Off: Deep Standby
- Red: When all Zone enter Quick Start Mode

3 Network indicators

Flashes green to indicate network activity. (👉 p. 57)

4 Zone indicators

Please refer to the “Status indicator Table”. (👉 p. 58)

■ Back panel

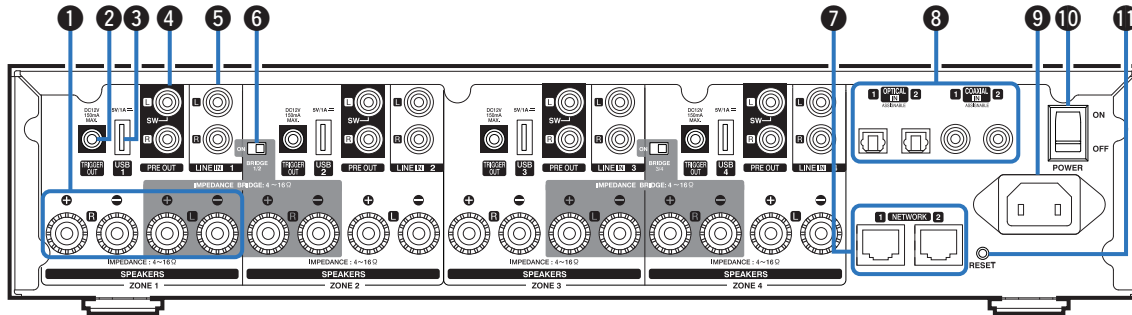

1 Speaker terminals (SPEAKERS)

Used to connect speakers. (☞ p. 14)

2 TRIGGER OUT jack (TRIGGER OUT)

Used to connect devices equipped with a trigger function. (☞ p. 17)

3 USB Input (USB 5 V/1 A)

Used to connect USB storage devices. (☞ p. 17)

4 Analog output (PRE OUT)

Used to connect external amplifiers. (☞ p. 16)

5 Analog Input (LINE IN)

Used to connect devices equipped with analog audio outputs. (☞ p. 18)

6 Bridge Mode Switch (BRIDGE)

Used to enable the amplifier bridge setting. (☞ p. 15)

7 NETWORK connector

Used to connect this unit to a wired Ethernet network. (☞ p. 21)

8 Digital Input (OPTICAL IN/COAXIAL IN)

Used to connect devices equipped with digital audio outputs. (☞ p. 18)

9 AC inlet

Used to connect the power cord. (☞ p. 20)

10 Master Power Switch (POWER)

11 RESET button

Various settings are reset to the factory default values. (☞ p. 54)

Placing your HEOS Drive

The HEOS Drive is designed to add HEOS multi-room audio functionality to passive loud speakers. You should place your HEOS Drive in a convenient location near your speaker wires.

- The HEOS Drive is not waterproof. Do not place it near any water source and do not leave it outside in the rain or snow.

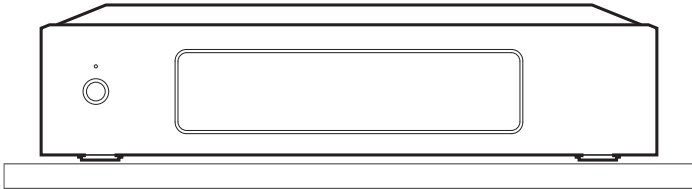

■ Attaching the rack mount brackets

Attach the included rack mounting brackets to the sides of the HEOS Drive if you want to mount the HEOS Drive in a standard EIA equipment rack.

- 1 Remove the two screws on each side of the HEOS Drive.**
- 2 Align the brackets with the screw holes and reattach the screws making sure they are secure.**

■ Mounting in a rack

- Do not cover the side of the unit. Remember, heat is dispersed from the HEOS Drive's side surface.
- Set up the installation environment carefully. For example, take care to protect the HEOS Drive from heat from other devices. If necessary, use forced ventilation. The surrounding conditions must meet the specifications described in "Specifications" (👉 p. 64).
- If the unit is not to be mounted in a rack, remove the rack mount brackets.

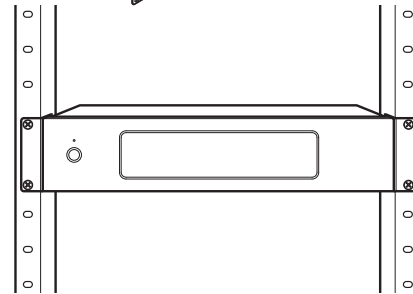
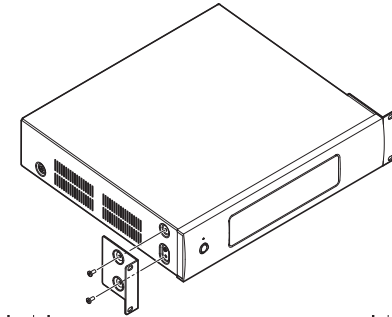

Zone connection

You can simultaneously play the same source in all four HEOS Drive Zones if desired. You can also play different sources in different zones. Connection and function of page 14 to 18 are ZONE1. ZONE2, ZONE3 and ZONE4 are same as ZONE1.

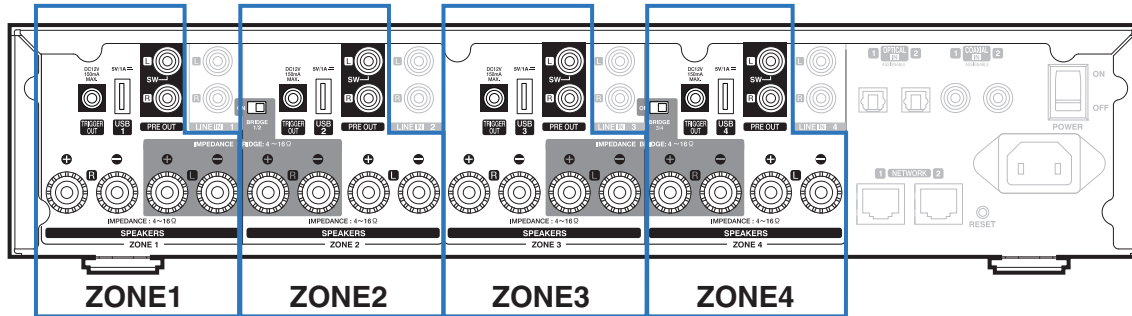

Connecting speakers (4 stereo zones)

■ Connecting speakers

Carefully check the left (L) and right (R) channels and + (red) and – (black) polarities on the speakers being connected to this unit, and be sure to connect the channels and polarities correctly.

- 1 Peel off about 3/8 inch (10 mm) of sheathing from the tip of the speaker cable, then either twist the core wire tightly or terminate it.



- 2 Turn the speaker terminal counterclockwise to loosen it.



- 3 Insert the speaker cable's core wire to the hilt into the speaker terminal.



- 4 Turn the speaker terminal clockwise to tighten it.



NOTE

- Turn off the power switch of rear panel before connecting the speakers. Also, turn off any connected powered subwoofers.
- Connect so that the speaker cable core wires do not protrude from the speaker terminal. The protection circuit may be activated if the core wires touch the rear panel or if the + and – sides touch each other.
- Never touch the speaker terminals while the power cord is connected and power switch of rear panel is turned on. Doing so could result in electric shock.
- Use speakers with an impedance of 4 – 16 Ω /ohms. The protection circuit may be activated if speakers with an impedance other than specified are used.
- Depending on the speakers that are connected, the protection circuit may activate and the power may be turned off when music is played at a high volume (The Power indicator flashes in red). If this happens, configure the “Volume Limit” setting. (☞ p. 43)

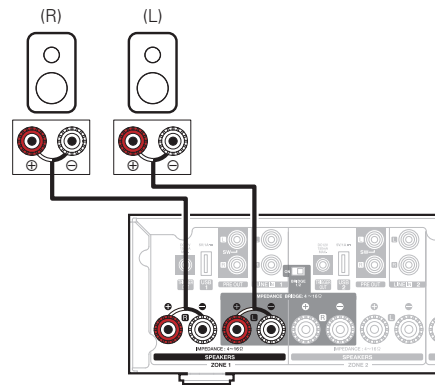

■ Connecting speakers (two bridged zones)

Larger output can be obtained by connecting using a bridged connection.

- 1 Turn off the power switch of rear panel.
- 2 Connect speakers to the adjacent gray colored speaker terminals between zones 1 and 2 OR zones 3 and 4.
- 3 Slide the Bridge switch to the “ON” position.

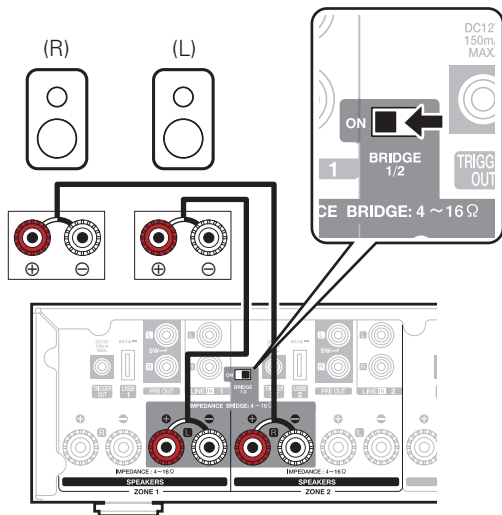

NOTE

- Turn off the power switch of rear panel before connecting the speakers. Also, turn off the subwoofer.
- Connect so that the speaker cable core wires do not protrude from the speaker terminal. The protection circuit may be activated if the core wires touch the rear panel or if the + and – sides touch each other.
- Never touch the speaker terminals while the power cord is connected and power switch of rear panel is turned on. Doing so could result in electric shock.
- Use speakers with an impedance of 4 – 16 Ω/ohms. The protection circuit may be activated if speakers with an impedance other than specified are used.
- In BRIDGE mode, one channel is output from one ZONE. In the example shown here, no signal is output from the speaker Rch of ZONE1 and Lch of ZONE2.
- Zones 1 and 2 connected using a bridge connection operate as Zone 1, and Zones 3 and 4 connected using a bridge connection operate as Zone 3.
- When a bridge connection is used, Zone2/Zone4 are not displayed in “Rooms view”. To display as Preamp Out, refer to “Adjusting the preamp out” (p. 43).

■ Connecting to an external amplifier or AV receiver

Connect the PRE OUT output to an available input on your amplifier or AV receiver using the appropriate cables.

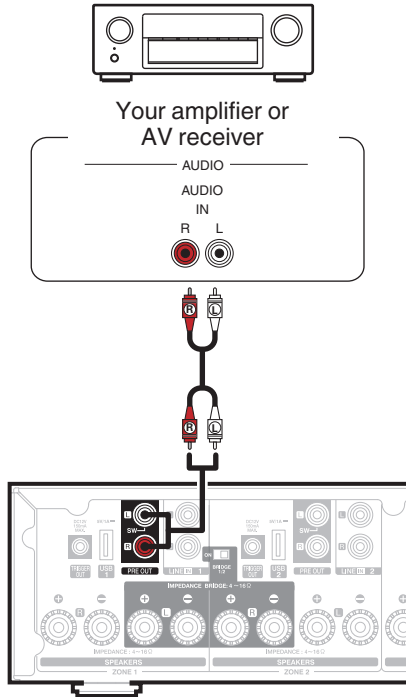

■ Connecting a subwoofer

Connect the PRE OUT "L" output to an input on your powered subwoofer or your subwoofer amplifier. (☞ p. 44)

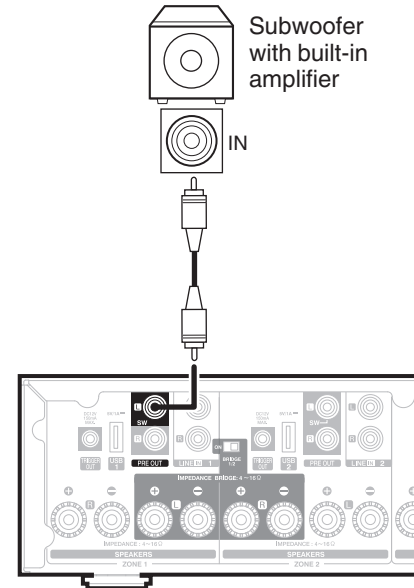

■ Connecting a USB storage device

Connect a FAT32 formatted USB storage device containing digital music files to any available USB port.

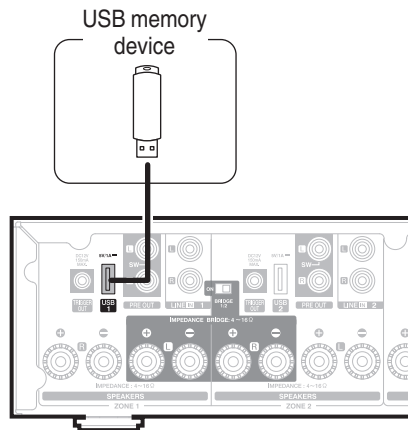

■ Trigger control

If the power amplifier connected to this unit has a trigger input connector, connect it to the TRIGGER OUT jack of this unit using a 3.5mm cable (not included). A signal up to 12 V/150 mA is output from the TRIGGER OUT jack.

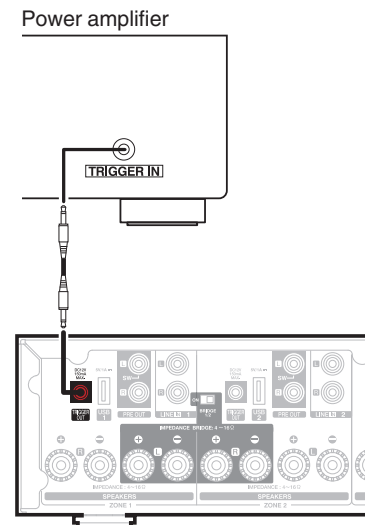

NOTE

- Use a monaural mini-plug cable for connecting the TRIGGER OUT jacks. Do not use a stereo mini-plug cable.
- The Trigger settings must be set in order to use Trigger Control. (☞ p. 48)

Connecting external devices (assignable)

■ Connecting an audio playback device

Connect the LINE IN, COAXIAL IN or OPTICAL IN input to an audio playback device (CD player, portable music player, etc...) using the appropriate cables.

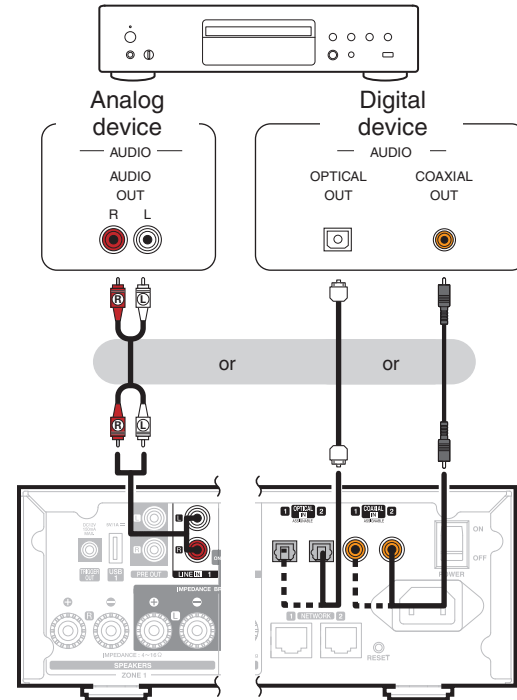

■ Connecting to network

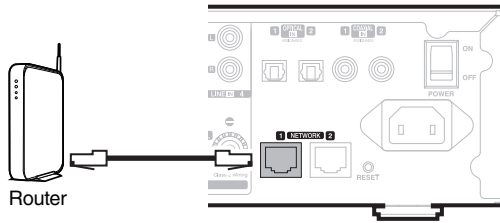

□ Daisy chain

You can use the second Ethernet connection to connect another HEOS Drive to your network.

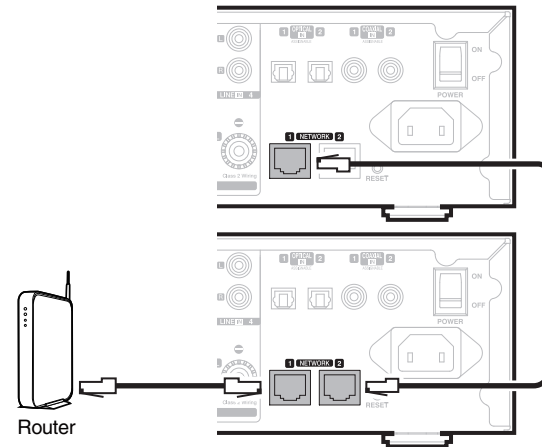

NOTE

- Each HEOS Drive contains four HEOS modules and therefore always counts as four devices towards the maximum number of 32 HEOS devices supported on any one network. Up to 8 HEOS Drive units are supported on a single network.

Powering your HEOS Drive

Connect the appropriate power cord for your region between the back of the HEOS Drive and a wall outlet and then switch the rear panel power switch to the ON position.

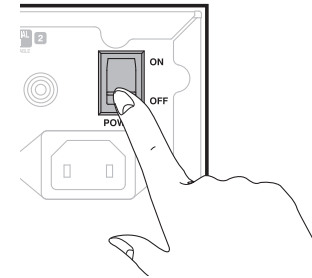
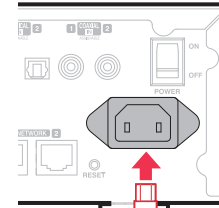
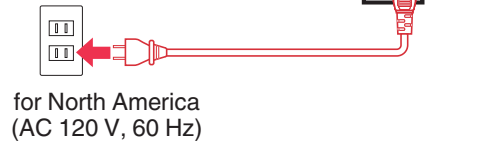
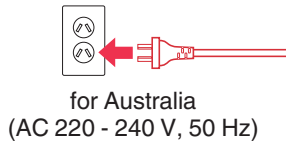
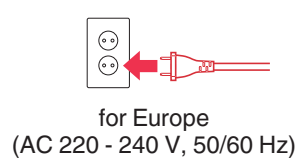
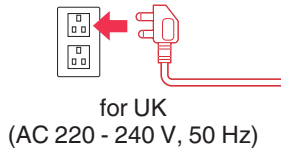

Getting the HEOS app

The HEOS app is the heart of the HEOS experience. Using your mobile device and the HEOS app, you can setup, browse, explore, and control your HEOS system right in the palm of your hand, from anywhere in your home.

Download the HEOS app for iOS or Android by searching App Store®, Google Play™ store or Amazon App Store for “HEOS by Denon”.



For the purpose of improvement, the specifications and design are subject to change without notice.

Adding more HEOS devices

The HEOS multi-room sound system is a true multi-room audio system that automatically synchronizes audio playback between multiple HEOS devices so that the audio coming from different rooms is perfectly in sync and always sounds amazing! You can easily add up to 32 devices to your HEOS system.

NOTE

- Each HEOS Drive contains four HEOS modules and therefore always counts as four devices towards the maximum number of 32 HEOS devices supported on any one network. Up to 8 HEOS Drive devices are supported on a single network.

Adding wired HEOS devices

Just connect the HEOS devices to your home network using an Ethernet cable and the HEOS devices will appear on your HEOS app as a new room in the “Rooms” screen.

At your convenience, you can assign a name to the HEOS devices to indicate which room you have it placed in.



- Use only a shielded STP or ScTP LAN cable which is easily available at electronics stores (CAT-5 or greater recommended).
- Do not connect a Network Connector directly to the LAN port/Ethernet connector on your computer.

Adding wireless HEOS devices

You can add additional wireless HEOS devices to your HEOS system by selecting “Add Device” from the HEOS app’s settings menu and follow the instructions:

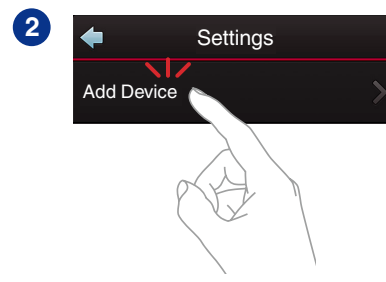
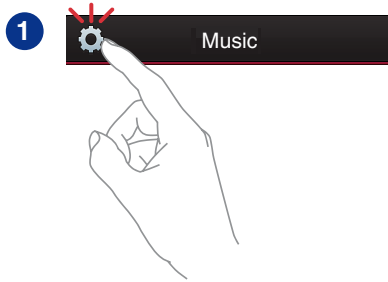

NOTE

- HEOS Drive can not be connected to a wireless network.

Using your HEOS DRIVE

Once you have your HEOS Drive connected to your network and the HEOS app installed on your mobile device, it's easy to start enjoying your favorite music. You can listen to something different in every room or the same music perfectly synchronized in all rooms. It's up to you!

Selecting a room

If you have more than one HEOS Drive, you must tell the HEOS system which one you want to control:

- 1 Tap the “Rooms” tab.
- 2 Select the Room you want to control.
- 3 Select the “Music” tab to select a music source or the “Now Playing” tab to control what is currently playing in the selected room.

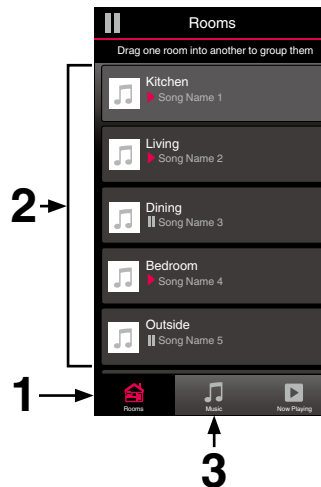

Listening to radio

The HEOS system includes access to more than 100,000 free internet radio streams from all corners of the globe via the TuneIn radio service. Just select the TuneIn logo from the main “Music” menu and browse among the 100,000 stations neatly organized into popular categories and select a station that appeals to your mood.

NOTE

If you have a TuneIn account, you can sign into the TuneIn service under Settings - Music Sources - TuneIn, and access all of your “My Favorites” TuneIn stations.

■ ■ ■ Audio signal

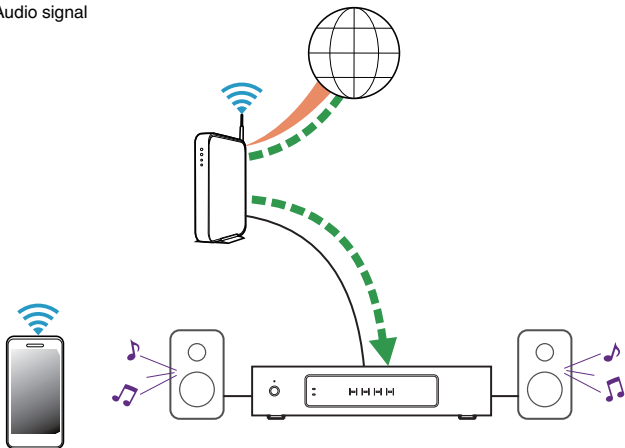

Playing music stored on your mobile device

- 1 Tap the “Music” tab.
- 2 Select “This iPhone/iPod/iPad/Phone”.
- 3 Browse the local music on your phone and select something to play.

■ ■ ■ Audio signal

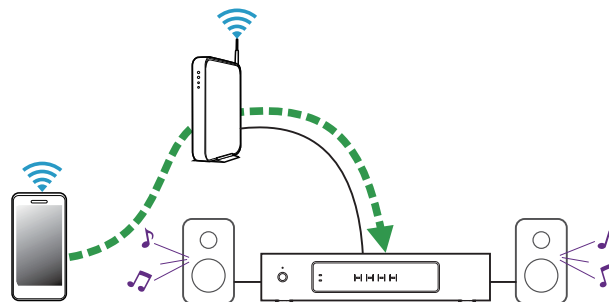

Playing music from your networked PC or NAS

- 1 Select “Music Servers” from the “Music” tab.
- 2 Select the name of your networked PC or NAS (Network Attached Storage) server.
- 3 Browse the music on your PC/NAS and select something to play.

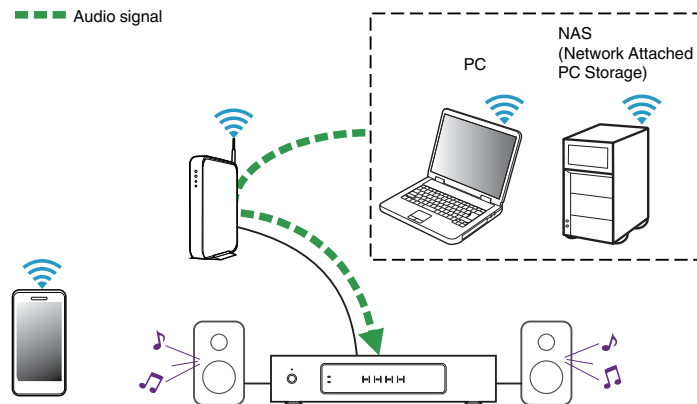

Playing music from an external audio device

- 1** Connect an external audio device to the digital optical, coaxial or analog RCA stereo input on the back of the HEOS Drive.
- 2** Select “Inputs” from the Music tab.
- 3** Select the name of the HEOS Drive and which input to which you connected the audio device in step 1.
- 4** Initiate playback on the audio device.

■ ■ ■ Audio signal

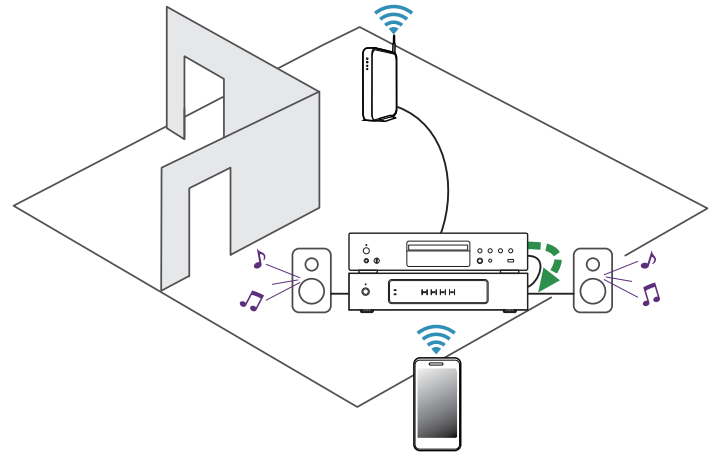

Streaming an external audio device to any HEOS device

The sound from the audio device can be played directly on the selected device or digitized and sent over your network to other HEOS devices.

- 1** Connect an external audio device to the digital optical, coaxial or analog RCA stereo input on the back of the HEOS Drive.
- 2** Select “Inputs” from the Music tab.
- 3** Select the name of the HEOS Drive and which input to which you connected the audio device in step 1.
- 4** Initiate playback on the audio device.

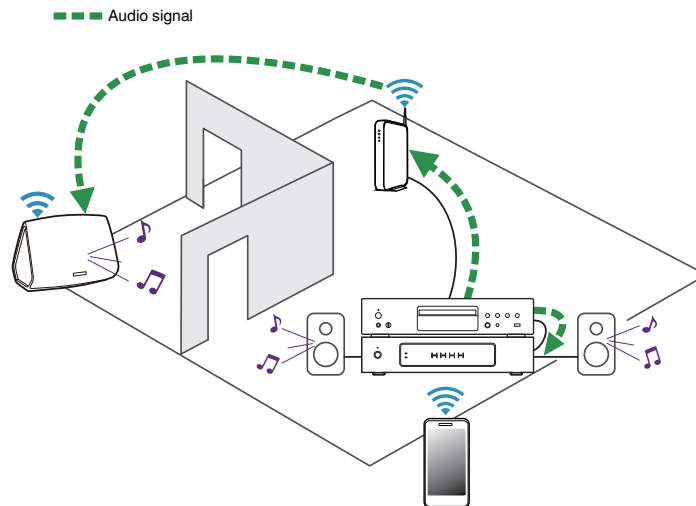

Playing music from a USB device

- 1** Insert a FAT32 formatted USB device into the USB port on the back of the HEOS Drive.
- 2** Select “USB Music” from the “Music” tab.
- 3** Select the name of the HEOS Drive and which input to which you connected the audio device in step 1.
- 4** Browse the music on your USB device and select something to play.

NOTE

- It may take several minutes for the name of your HEOS Drive to appear in the “USB Music” list if you have a large number of files on your USB device.
- It is not possible to connect and use a computer via the USB port of this unit using a USB cable.

■ ■ ■ Audio signal

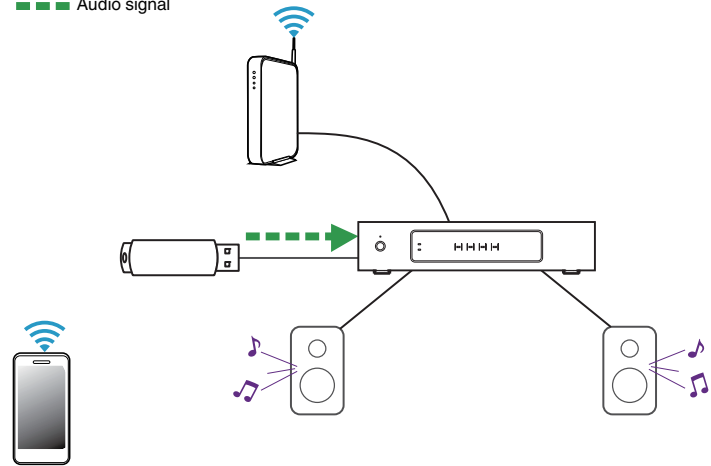

HEOS account

■ What is a HEOS account?

A HEOS account is master account or “keychain” for managing all of your HEOS music services with one single username and password.

■ Why do I need a HEOS account?

With the HEOS account you just have to enter your music services login names and passwords one time. This allows you to easily and quickly use multiple controller apps on different devices. You just log into your HEOS account on any device and you will have access to all of your associated music services, play history and custom playlists, even if you are at a friend’s house listening to music on their HEOS system.

■ Signing up for a HEOS account

You will be instructed to signup for a HEOS account the first time you try to access any music service from the main “Music” menu of the HEOS app.

■ Changing your HEOS account

- 1 Tap the “Music” tab.
- 2 Select the Settings  icon in the upper left corner of the screen.
- 3 Select “HEOS Account”.
- 4 Change your location, change your password, delete your account or sign out of your account.

Playing from streaming music services

A music service is an online music company that provides access to vast music collections via free and/or paid subscriptions. Depending upon your geographical location, there are several options to choose from. For more information about which services are available in your area please visit <http://www.HEOSbyDenon.com>

■ Adding a music service

Once you've setup your HEOS account, you can add supported music services to your HEOS system by tapping on the music service logo in the "Music" tab.

Follow the instructions on the screen to add your username and password for the selected music service. You only have to enter your account information once as the HEOS account service will securely remember your login information so you don't have to enter it each time you want to play music from the music service.

Additional music services may be available under Settings - Music Services.

■ Changing music service settings

- 1 Tap the "Music" tab.
- 2 Select the Settings  icon in the upper left corner of the screen.
- 3 Select "Music Sources".
- 4 Select "Online Music".
- 5 Select the name of the online music service you want to edit.
- 6 Sign out, then sign in again to associate your username and password with your HEOS account.
- 7 Select "Hide for Now" to prevent the service logo from appearing on the main "Music" menu.

Managing inputs

If you connected external audio source components to any of your HEOS devices inputs, you can rename the default input names to describe the actual source or hide any inputs that are not being used.

- 1** Select the **Settings**  icon located in the upper left corner of the main “Music” menu to display the Settings menu.
- 2** Select “Music Sources”.
- 3** Select “Inputs”.
- 4** Select the HEOS devices which you connect your external audio source device to.

■ Changing the name of the inputs

- 1** Select the name of the input you want to edit.
- 2** Select “Name”.
- 3** Select or enter a new name to describe the source that you connected.
- 4** Select the Save button to save your changes.

■ Hiding an input

- 1** Select the name of the input you want to edit.
- 2** Toggle “Hide Input” to ON to prevent this input from appearing under the Inputs tile on the main “Music” menu.

Managing your phone

Your smartphone or tablet can be hidden if it does not need to be in the “Music Sources” menu.

- 1** Select the Settings  icon located in the upper left corner of the main “Music” menu to display the Settings menu.
- 2** Select “Music Sources”.
- 3** Select “This iPhone/iPod/iPad/Phone”.
- 4** Toggle “This iPhone/iPod/iPad/Phone” to OFF to prevent the service logo from appearing on the main “Music” menu.

Listening to the same music in multiple rooms

The HEOS system is a true multiroom audio system that automatically synchronizes audio playback between multiple devices so that the audio coming from different rooms is perfectly in sync and always sounds amazing!

You can easily add up to 32 devices to your HEOS system.

You can join or group up to 16 individual HEOS devices into a group of HEOS devices that function as if they were a single HEOS device.

■ Grouping rooms

- 1 Tap the “Rooms” tab.
- 2 Press and hold your finger on room that is not playing music.
- 3 Drag it into the room that is playing music (indicated by the red outline) and lift your finger.

The two rooms will be grouped together into a single device group and both rooms will be playing the same music in perfect sync.

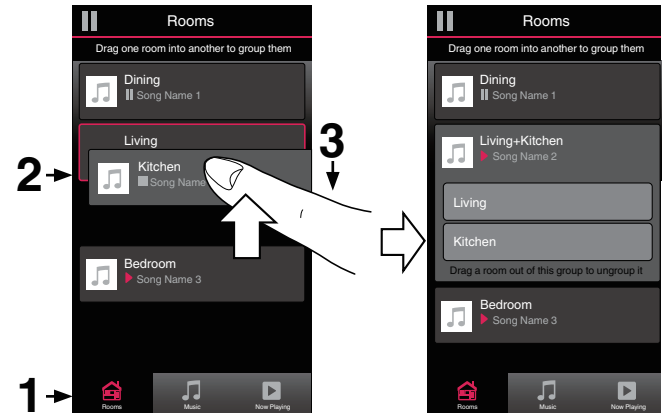

■ Ungrouping rooms

- 1 Tap the “Rooms” tab.
- 2 Press and hold your finger on room that you want to remove from the group.

NOTE

- You can not remove the first room that started playing the music before grouping.

- 3 Drag it out of the group and lift your finger.

Music will stop playing in the room you dragged out of the group but will continue playing in any remaining rooms.

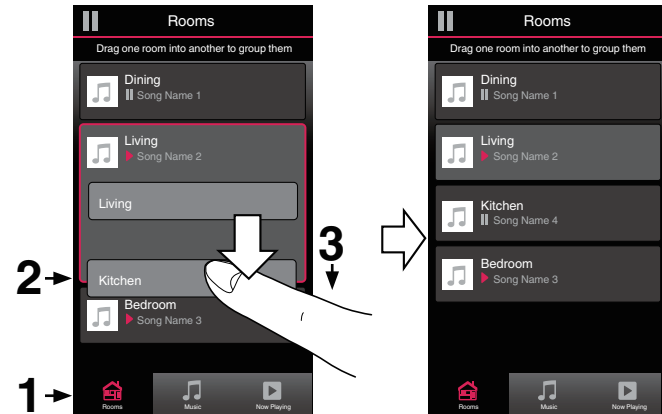

■ Grouping all rooms (party mode)

You can easily group 16 rooms together into Party Mode by using a “pinch” gesture.

- 1 Tap the “Rooms” tab.
- 2 Place two fingers on the screen over the list of rooms.
- 3 Quickly pinch your two fingers together and release.

All of your rooms will be joined together and begin playing the same music in perfect sync.

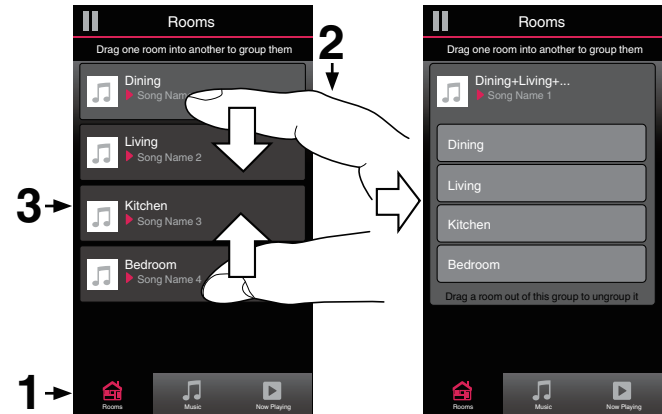

■ Ungrouping all rooms

You can easily ungroup all of your rooms and exit Party Mode by using a “spread” gesture.

- 1 Tap the “Rooms” tab.
- 2 Place two fingers close together on the screen over list of rooms.
- 3 Quickly spread your two fingers apart from each other and release.

All of your rooms will be ungrouped and music will stop playing in every room (except the original “master” room that was playing before you grouped the rooms together).

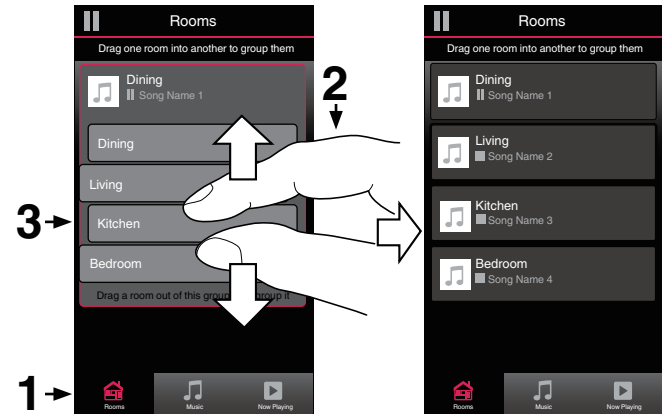

Using the now playing queue

HEOS uses a Now Playing “Queue” to line up music that you want to listen to. Music can be selected from any of your local or online music sources (as long as they are not preprogrammed “radio” or “station” type streams). This feature works similarly to how a jukebox works. You select something to play (a song, album, playlist or even your entire music collection) and add it to the “Queue”. When you select something to play you will be asked how you want to queue up your music.

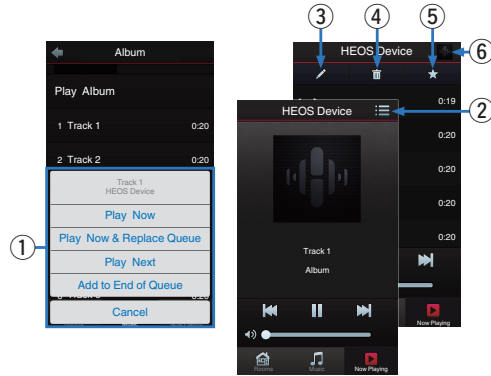

1 Queue Menu

When you select something to play you will be asked how you want to queue up your music.

2 Queue icon

3 Pencil icon

4 Delete icon

5 Save icon

6 Cover art or HEOS icon

You can return to the “Now Playing” screen display by tapping the cover art or the HEOS icon.

■ Play Now

Inserts the item into the queue after the currently playing track and plays the selected item immediately.

■ Play Now & Replace Queue

Clears the queue and plays the selected item immediately.

■ Play Next



Inserts the item into the queue after the current song and plays it when the current song ends.

■ Add to End of Queue

Adds the item to the end of the queue.



Rearranging the now playing queue

Once you have songs lined up in your queue, you might want to rearrange the order or remove some songs:

- 1 Tap the “Now Playing” tab.
- 2 Tap the Queue  icon in the upper right corner of the screen.
- 3 Tap the Pencil  icon to enter Edit mode.
- 4 Rearrange the order of your queue by dragging the list  icon (on the right side of each track row) up or down.



Deleting songs from the play queue

You can remove songs one at a time from the Now Playing Queue:

- 1 Tap the “Now Playing” tab.
- 2 Tap the Queue  icon in the upper right corner of the screen.
- 3 Tap the Pencil  icon to enter Edit mode.
- 4 Tap the track(s) that you want to delete.
- 5 Tap the Delete  icon to delete all of the selected tracks from the play queue.



Deleting all songs from the play queue

You can remove all of the songs from the Now Playing Queue:

- 1 Tap the “Now Playing” tab.
- 2 Tap the Queue  icon in the upper right corner of the screen.
- 3 Tap the Delete  icon to confirm that you want to delete all songs from the queue.



Saving playlists

You can save the Now Playing Queue as a HEOS Playlist that you can recall later. The new playlist will be available from the Playlists button on the “Music” tab on every controller app connected to your HEOS system.

- 1 Tap the “Now Playing” tab.
- 2 Tap the Queue  icon in the upper right corner of the screen.
- 3 Tap on the Save  icon.
- 4 Enter a name for your Playlist and tap the Save  icon.

Performing repeat and shuffle playback

The playback controls are visible on the “Now Playing” screen.

- 1 Tap the “Now Playing” tab.
- 2 Tap the cover art to reveal the repeat  and shuffle  controls.

Using the favorite

HEOS uses a "HEOS Favorite" to line up station you want to start play quickly the favorite stations. Station can be selected from online music sources such as "Radio" or "Station" type streams. "HEOS Favorite" will display a list of the stations of various services.

■ Adding to HEOS favorite

Select a station of an online music source. When the action menu screen is displayed, select "Add station to HEOS favorite".

NOTE

- This can also be done by selecting "Add station to HEOS favorite" from the station menu of the station being played.

■ Deleting station from the HEOS favorite

- 1 Tap the "Music" tab.
- 2 Select "Favorite".
- 3 Tap the Pencil  icon to enter Edit mode.
- 4 Tap the "Delete" that you want to delete station.

Making adjustments

You can adjust specific settings for each of your HEOS Drives in your system:

- 1** Select the Settings  icon located in the upper left corner of the main “Music” menu to display the Settings menu.
- 2** Select “My Devices” to display a list of your devices.
- 3** Select the HEOS Drive and the Zone you want to adjust.

Changing the name of a HEOS Drive

- 1** Select “Name”.
- 2** Select or enter a new name for your HEOS Drive.
- 3** Tap the “Next” to save your changes.

Changing the name of a zone

- 1** Select “Name”.
- 2** Select or enter a new name for your HEOS Drive.
- 3** Tap the “Next” to save your changes.

Adjusting the equalizer

- 1 Select “EQ”.
- 2 Adjust the “Treble” or “Bass” up or down.



- Select the Reset button to restore the default settings.

Adjusting the balance

- 1 Select “Balance”.
- 2 Adjust the Balance to the left or right.

Adjusting the output mode

- 1 Select “Output Mode”.
- 2 Select Stereo or Dual Mono.

Adjusting the audio quality

Selects the transcoding option for rebroadcasting audio from one HEOS device to another HEOS device (or group of devices) across the network. When set to high bit rate audio sources originating from the first device (such as Analog input, WAV, FLAC and PCM) will be transcoded to ensure the highest level of reliability for the audio stream. ( p. 27)

- 1 Select “Quality”.
- 2 Select “Normal” (default) or “High”.



- If you have selected High and you experience audio dropouts when streaming sources from one device to other devices, please select Normal (default).

Adjusting the volume limit

You can set the maximum volume of the HEOS Drive amplifiers to prevent sudden loud volume.

- 1 Select “Volume Limit”.
- 2 Select the maximum volume percentage (95, 90, 85, 80).

NOTE

- Depending on the speakers that are connected, the protection circuit may activate and the power may be turned off when music is played at a high volume. (The Power indicator flashes in red.) If this happens, configure the “Volume Limit” setting.

Adjusting the preamp out

ZONE2 and ZONE 4 “Volume limit” will change to “Preamp Out”, when you set the Bridge switch to “ON”.

- 1 Select “Preamp Out”.
- 2 Select Disabled or Enabled.

Disabled (Default):	PRE OUT is disabled and does not appear in Rooms view.
Enabled:	PRE OUT is enabled and Zone Name appeared in Rooms view.

Adjusting the high pass filter

Set the High Pass Filter to limit the low frequency signal being sent to your speakers.

- 1 Select “High Pass Filter”.
- 2 Select the frequency cutoff point:

40 Hz / 80 Hz / 90 Hz / 100 Hz / 110 Hz / 120 Hz / 150 Hz / 200 Hz / 250 Hz



If you enable the IP control, “High Pass Filter” will be disappeared and forced to change.

Using a subwoofer

- 1 Select “Subwoofer”.
- 2 Enable the Sub Out (L) setting.



If you enable the IP control, “Subwoofer” will be disappeared and forced to change.

Adjusting the Low Pass Filter

When Subwoofer is set to on, you can limit the high frequency signal being sent to your subwoofer.

- 1 Select “Subwoofer”.
- 2 Select “Low Pass Filter”.
- 3 Set the frequency cutoff point.

40 Hz / 60 Hz / 80 Hz / 90 Hz / 100 Hz / 110 Hz / 120 Hz

Adjusting the line out

- 1 Select “Line Out Level”.
- 2 Select Fixed to lock the volume at the optimal level or select Variable to control the volume from the Now Playing screen.



If you enable the IP control, “Line Out Level” will be disappeared and forced to change.

Adjusting the status light brightness

- 1 Select “Status Light”.
- 2 Adjust the brightness up or down or set the slider to the OFF position to completely disable the status light.

Advanced settings

Caution

- Adjusting these settings may disconnect your device from your network and possibly render your device unusable. Do not use these features unless you are comfortable making advanced adjustments.

■ Network settings

- Select “Advanced”.
- Select “NETWORK SETTINGS” tab.
 - Manual or static IP address for your device
 - Deep Standby ( p. 51)
- Select Save Settings to apply the new settings or Cancel Changes to revert to the previous settings.

NOTE

- “Deep Standby” needs to be set in all four zones to enable this setting.

■ Firmware upgrade

- Select “Advanced”.
- Select “FIRMWARE UPDATE” tab.
 - Update status

Manually check for a firmware upgrade.
 - Allow updates

ON:	Allows updates
OFF:	Does not allow updates
- Select Save Settings to apply the new settings or Cancel Changes to revert to the previous settings.

■ About

Viewing technical details about the HEOS device.

- 1** Select “Advanced”.
- 2** Select “ABOUT” tab.
- 3** Scroll down to see information about the device’s
 - a. Hardware
 - b. Software
 - c. Device

External device control

The HEOS Drive can tightly integrate with most Denon AV receiver to allow them to operate as if they were one device.

You can configure your HEOS Drive to tell the connected device when to turn on, turn off, select the correct input and adjust volume and mute.

You can adjust specific settings for each of your HEOS Drive in your system:

- 1** Select the **Settings**  icon located in the upper left corner of the main “Music” menu to display the **Settings** menu.
- 2** Select “My Devices” to display a list of your devices.
- 3** Select a HEOS Drive.
- 4** Select the Zone you want to set.
- 5** Select “Control”.
- 6** Select the method which is most appropriate for your configuration:

■ IP Control

IP Control is available for Denon AV receiver models sold after 2010 which are connected to the same network as the HEOS Drive and Controller devices.

- 1** Select **IP**.
- 2** Select the AV receiver that you have your HEOS Drive is connected to.
- 3** Select the input on the AV receiver that you have your HEOS Drive connected to.
- 4** Select **Done**.

NOTE

- You can test the connection to the AV receiver by pressing the power on, off, and input buttons.
- The following settings are forced to change when IP Control is set.
 - Line Out Level: Fixed
 - High Pass Filter: Off
 - Subwoofer: Off

■ Trigger out

Select Trigger Control when you are connecting your HEOS to a power amp that supports +12 V trigger input.

The HEOS app can control the power on and off for the amp.

1 Select **Trigger**.

2 Select **Done**.

NOTE

- You can test the connection to the amp by pressing the power on, off in setting screen for the amp.

Updating your system

HEOS has the ability to add enhancements and updated functionality via your high speed Internet connection. Follow the instructions on the screen to update the HEOS device and/or your controller App.

- 1** Select the Settings  icon located in the upper left corner of the main “Music” menu to display the Settings menu.
- 2** Select “Software Update”.

Check for Update

Follow the instructions on screen to install any available updates to your HEOS system.

Auto-Update

ON:	Valid updates are performed automatically.
OFF:	You will be notified of valid updates on the HEOS app.

Advanced features

There are a few advanced features of the HEOS system that you may want to explore once you become familiar with the basic operations. You can access the advanced features of the HEOS system by following these steps:

- 1 Select the Settings  icon located in the upper left corner of the main “Music” menu to display the Settings menu.**
- 2 Select “Advanced Settings” to display a list the available settings.**

Sharing music from your mobile device

The HEOS app has a feature called “Music Sharing” which can share the local music stored on your mobile device to other HEOS app users on your local network. To enable this feature, select “Music Sharing”, and set it on “ON”.

The name of the device you are sharing from will appear as a music server allowing other HEOS controller apps to browse and play music from the your device.

Submit diagnostics

If you are having trouble with your network or HEOS system, you may be asked by Denon technical support personnel to select this option. This feature will automatically send Denon technical support diagnostic information about your HEOS system.

NOTE

- No personal information is sent and your information will never be shared with anyone.

Resetting your controller app

This feature will reset the control app to its original state when you first installed it on your mobile device without requiring you to remove, download, and reinstall it from the app store.

Power management

Power modes

■ Quick Start Mode

To save power, the device will automatically enter “Quick Start Mode” whenever there is no network access or playback for 20 minutes and will automatically resume to full power whenever the device is selected and playing music.

The each Zone indicator will be dimmed during Quick Start Mode as it is a fully automatic function.

Also push Power button, the device enter Quick Start Mode.

When all zone enter Quick Start Mode, Power indicator will be red.

The wired connections remain on while in Quick Start Mode.

■ Deep Standby

The device also has the ability to automatically enter “Deep Standby” whenever the wired network connections are removed for more than 60 minutes in Quick Start Mode. Power indicator will turn off during Deep Standby. Please note that the HEOS cannot be operated as intended when in Deep Standby as there is no network connection. To “wake” a HEOS device from Deep Standby, you must press the standby button which will immediately turn on Power indicator. The Device may need to “find” the network before it can operate properly. Power button for more than 6 seconds, the device enter Deep Standby.

NOTE

- “Deep Standby” needs to be set in all four zones to enable this setting.

■ Off

To completely turn off the power to the device you must switch to OFF of power switch on rear panel.

BASIC TROUBLESHOOTING

My HEOS device turns off and the power LED flashes in red

Solution	Refer to Page
<ul style="list-style-type: none">• The protection circuit has been activated due to a rise in temperature within your HEOS device. Turn the power off, wait about an hour until this device cools down sufficiently, and then turn the power on again.	–
<ul style="list-style-type: none">• Check the speaker connections. The protection circuit may have been activated because speaker cable core wires came in contact with each other or a core wire was disconnected from the connector and came in contact with the rear panel of this device. After unplugging the power cord, take corrective action such as firmly re-twisting the core wire or taking care of the connector, and then reconnect the wire.	14
<ul style="list-style-type: none">• Depending on the speakers that are connected, the protection circuit may activate and the power may be turned off when music is played at a high volume. (The Power indicator flashes in red) If this happens, configure the “Volume Limit” setting.	43

Music cuts out or delays sometimes

Solution	Refer to Page
<ul style="list-style-type: none">• Make sure your Internet connection is operating correctly. If you are sharing your network with other users or devices, they may be using most of your bandwidth (especially if they are streaming video).	<u>6</u>

I hear a delay when using the external input with my TV

Solution	Refer to Page
<ul style="list-style-type: none">• If you are connecting the External input with your cable or satellite box for enjoying TV audio through multiple HEOS devices, you may hear a delay between when you see someone speak and when you hear the audio. This is because the HEOS system must buffer the audio before it sends it out to the HEOS devices so that it arrives at all devices at the same time.	<u>26</u>
<ul style="list-style-type: none">• You can avoid this delay by listening only to the device which is directly connected to the set top box.	—

Resetting your HEOS device

Solution	Refer to Page
Resetting your HEOS device will clear out EQ, and name but retain it's current software. You will have to use Settings->Add Device to reconnect the device to your home network before it can be used. To reset your HEOS Drive, press the Reset button on the back and hold it in until the Zone LED begins to flash amber.	-

Restoring the HEOS device to factory defaults

Solution	Refer to Page
<p>Restoring the HEOS device to its factory defaults will clear all of the settings and restore the original software which was installed at the factory.</p> <p>Caution</p> <ul style="list-style-type: none"> All settings will be erased and the software will likely be downgraded! <p>To restore your HEOS Drive to the factory defaults, turn off the power switch of rear panel. Press the Reset button on the back, turn on the power switch of rear panel, and hold it in until the Zone LED begins to flash amber.</p>	-

* For further information, please visit <http://www.HEOSbyDenon.com>

Contact Denon

For U.S. & Canada only:

If you need further assistance with your HEOS product, please contact HEOS by Denon Customer Support Services below:

Website: www.HEOSbyDenon.com/Support

Email: Support@HEOSbyDenon.com

Live Chat: www.HEOSbyDenon.com/LiveChat

Telephone: Toll Free (855) 499 2820

(M-F 10:00AM to 10:00PM EST / Sat 12:00PM to 8:00PM EST)





For the other region:

If you need additional help in solving problems, please contact Denon customer service in your area or visit <http://www.HEOSbyDenon.com>





Status LED table





■ Power indicator



Device Operation	Description	Front LED Action
OFF	No AC power, Master Power Switch OFF, Deep Standby	 (off)
ON	Power ON	 (solid)
Power Management	Quick Start Mode-When all Zone enter Quick Start Mode	 (solid)
Error	Hardware protection - Refer to “BASIC TROUBLESHOOTING” (📖 p. 52)	 (blink)

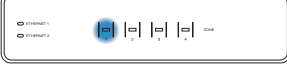

■ Network indicators



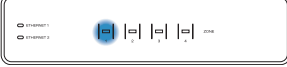

Device Operation	Description	Front LED Action
OFF	Not Connected to your network	 <p>(off)</p>
Connect	Connected to your network	 <p>(solid)</p>

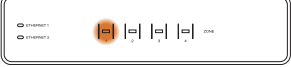

■ Zone indicators

Device Operation	Description	Front LED Action
OFF	No AC Power, Master Power Switch OFF, Deep Standby	 <p>(off)</p>
Master Power Switch ON	Booting	 <p>(blink)</p>
ON	Ready-Configured and connected to your network	 <p>(solid)</p>
	Not Connected to your network	 <p>(solid)</p>

Device Operation	Description	Front LED Action
Update	Updating	 <p>(blink)</p>
	Rebooting	 <p>(blink)</p>
	Ready-Configured and connected to your network	 <p>(solid)</p>

Device Operation	Description	Front LED Action
Reset	Soft reset - Clear user settings	 <p>(fast blink)</p>
	Hard reset - Factory restore	 <p>(blink)</p>
	Rebooting	 <p>(blink)</p>
	Ready-Not Configured	 <p>(solid)</p>

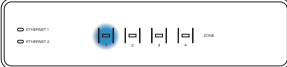
Device Operation	Description	Front LED Action
Errors	Firmware Error	 <p>(slow blink (NOT fade))</p>
	Hardware Error	 <p>(fast blink)</p>
	Network Error	 <p>(solid)</p>
Volume Change		 <p>(quick blink)</p>
Mute		 <p>(slow blink)</p>

Device Operation	Description	Front LED Action
Power Management	Quick Start mode-When all Zone enter Quick Start Mode	 <p>(solid)</p>
	Deep Standby	 <p>(off)</p>

Supported file types and codecs

Frequency	Sample Rate	File Extension	Codec	Bit Rates
32/44.1/48 88.2/96/176.4 192 kHz	16/24 bit	wav	PCM	---
32 kHz 44.1 kHz 48 kHz	16 bit	mp3	MPEG-1 Audio Layer 3 CBR/VBR	32 - 320 kbps
32 kHz 44.1 kHz 48 kHz	16 bit	m4a aac	AAC-LC	48 - 320 kbps
32 kHz 44.1 kHz 48 kHz	16 bit	wma	wma9 CBR	CBR:48 - 192 kbps
44.1/48 88.2/96/176.4 192 kHz	16/24 bit	flac	flac	---
44.1/48 88.2/96/176.4 192 kHz	16/24 bit	m4a	ALAC	---

NOTE

- Files protected by DRM such as Apple's Fairplay DRM, are not supported.
- If you select a music source with a high bit rate or high resolution, it is set to the appropriate level by codec before being output.

Supported audio formats (Coaxial/Optical)

2-channel Linear PCM:2-channel, 32 kHz – 192 kHz, 16/20/24 bit

Bitstream:Dolby Digital



Specifications

■ Audio section

- Power amplifier

Maximum output power:

(NORMAL OPERATION)

8-channel driving

60W + 60W (8 Ω /ohms, 20 Hz – 20 kHz, T.H.D. 0.05 %)

(BRIDGE OPERATION)

4-channel driving

130W + 130W (8 Ω /ohms, 20 Hz – 20 kHz, T.H.D. 0.05 %)

Rated output:

(NORMAL OPERATION)

8-channel driving

60W + 60W (8 Ω /ohms, 20 Hz – 20 kHz, T.H.D. 0.07 %)

(BRIDGE OPERATION)

4-channel driving

120W + 120W (8 Ω /ohms, 20 Hz – 20 kHz, T.H.D. 0.07 %)

Output connectors:

(NORMAL OPERATION)

4 – 16 Ω /ohms

(BRIDGE OPERATION)

4 – 16 Ω /ohms

THD+N:

0.05 % (20 Hz - 20 kHz)

S/N:

95 dB (IHF–A weighted)

Frequency response:

20 Hz to 20 kHz: ± 1 dB

■ General

Operating temperature:	41 °F - 95 °F (5 °C - 35 °C)
Power supply:	AC 120 V, 60 Hz (for North America) AC 220 - 240 V, 50/60 Hz (for Europe, UK and Australia)
Power consumption:	170 W (for North America) 160 W (for Europe, UK and Australia)
Power consumption in Deep Standby Mode:	0.3 W

■ Dimensions (Unit : in. (mm))

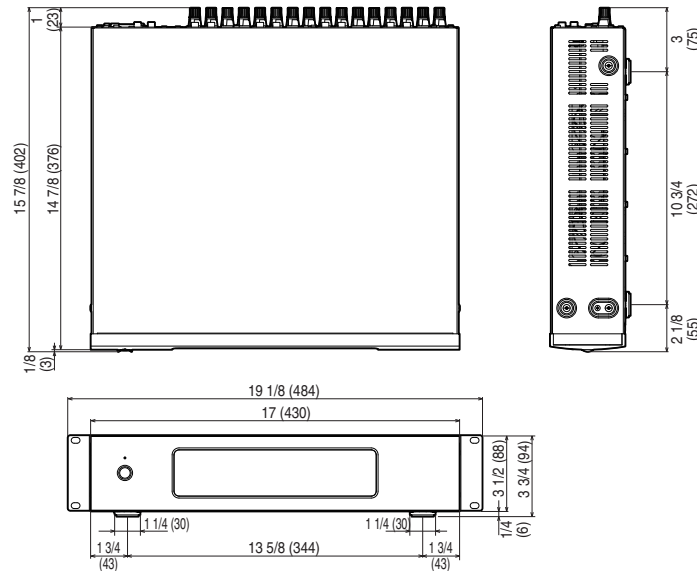

■ Weight :

16 lbs 9 oz (7.6 kg) (with brackets)

15 lbs 14 oz (7.3 kg) (w/o brackets)

For the purpose of improvement, the specifications and design are subject to change without notice.

Information

Trademarks



Manufactured under license from Dolby Laboratories. Dolby, Dolby Audio, Pro Logic, and the double-D symbol are trademarks of Dolby Laboratories.



Google Play and the Google Play logo are trademarks of Google Inc.



Apple, the Apple logo, iPad, iPhone, and iPod touch are trademarks of Apple Inc., registered in the U.S. and other countries. App Store is a service mark of Apple Inc.



Amazon, Kindle, Echo, Alexa, Dash, Fire and all related logos are trademarks of Amazon.com, Inc. or its affiliates.

License

■ License information for the software used in the unit

About GPL (GNU-General Public License), LGPL (GNU Lesser General Public License) License

This product uses GPL/LGPL software and software made by other companies.

After you purchase this product, you may procure, modify or distribute the source code of the GPL/LGPL software that is used in the product.

Denon provides the source code based on the GPL and LGPL licenses at the actual cost upon your request to our customer service center. However, note that we make no guarantees concerning the source code. Please also understand that we do not offer support for the contents of the source code.

This section describes software license used for this unit. To maintain the correct content, the original (English) is used.

□ GPL

Open Source Used	Version
bridge-utils	2.8
busybox	1.21.1
ebtables	2.0.10-4
Linux kernel	3.10.74
mtd-utils	1.4.3
ntfs-3g_ntfsprogs	2011.4.12
ntpclient	2007
u-boot	2015.01
wireless-tools	version 29

□ LGPL

Open Source Used	Version
ffmpeg	0.8.3
glibc	2.9
libmms	0.6.2

□ curl-7.24.0

COPYRIGHT AND PERMISSION NOTICE

Copyright (c) 1996 - 2014, Daniel Stenberg, <daniel@haxx.se>

All rights reserved.

Permission to use, copy, modify, and distribute this software for any purpose with or without fee is hereby granted, provided that the above copyright notice and this permission notice appear in all copies.

THE SOFTWARE IS PROVIDED "AS IS", WITHOUT WARRANTY OF ANY KIND, EXPRESS OR IMPLIED, INCLUDING BUT NOT LIMITED TO THE WARRANTIES OF MERCHANTABILITY, FITNESS FOR A PARTICULAR PURPOSE AND NONINFRINGEMENT OF THIRD PARTY RIGHTS. IN NO EVENT SHALL THE AUTHORS OR COPYRIGHT HOLDERS BE LIABLE FOR ANY CLAIM, DAMAGES OR OTHER LIABILITY, WHETHER IN AN ACTION OF CONTRACT, TORT OR OTHERWISE, ARISING FROM, OUT OF OR IN CONNECTION WITH THE SOFTWARE OR THE USE OR OTHER DEALINGS IN THE SOFTWARE.

Except as contained in this notice, the name of a copyright holder shall not be used in advertising or otherwise to promote the sale, use or other dealings in this Software without prior written authorization of the copyright holder.



❑ e2fsprogs-libs-1.40.8/lib/uuid

Redistribution and use in source and binary forms, with or without modification, are permitted provided that the following conditions are met:

1. Redistributions of source code must retain the above copyright notice, and the entire permission notice in its entirety, including the disclaimer of warranties.
2. Redistributions in binary form must reproduce the above copyright notice, this list of conditions and the following disclaimer in the documentation and/or other materials provided with the distribution.
3. The name of the author may not be used to endorse or promote products derived from this software without specific prior written permission.

THIS SOFTWARE IS PROVIDED "AS IS" AND ANY EXPRESS OR IMPLIED WARRANTIES, INCLUDING, BUT NOT LIMITED TO, THE IMPLIED WARRANTIES OF MERCHANTABILITY AND FITNESS FOR A PARTICULAR PURPOSE, ALL OF WHICH ARE HEREBY DISCLAIMED. IN NO EVENT SHALL THE AUTHOR BE LIABLE FOR ANY DIRECT, INDIRECT, INCIDENTAL, SPECIAL, EXEMPLARY, OR CONSEQUENTIAL DAMAGES (INCLUDING, BUT NOT LIMITED TO, PROCUREMENT OF SUBSTITUTE GOODS OR SERVICES; LOSS OF USE, DATA, OR PROFITS; OR BUSINESS INTERRUPTION) HOWEVER CAUSED AND ON ANY THEORY OF LIABILITY, WHETHER IN CONTRACT, STRICT LIABILITY, OR TORT (INCLUDING NEGLIGENCE OR OTHERWISE) ARISING IN ANY WAY OUT OF THE USE OF THIS SOFTWARE, EVEN IF NOT ADVISED OF THE POSSIBILITY OF SUCH DAMAGE.

❑ expat-2.0.1

Copyright (c) 1998, 1999, 2000 Thai Open Source Software Center Ltd and Clark Cooper

Copyright (c) 2001, 2002, 2003, 2004, 2005, 2006 Expat maintainers.

Permission is hereby granted, free of charge, to any person obtaining a copy of this software and associated documentation files (the "Software"), to deal in the Software without restriction, including without limitation the rights to use, copy, modify, merge, publish, distribute, sublicense, and/or sell copies of the Software, and to permit persons to whom the Software is furnished to do so, subject to the following conditions:

The above copyright notice and this permission notice shall be included in all copies or substantial portions of the Software.

THE SOFTWARE IS PROVIDED "AS IS", WITHOUT WARRANTY OF ANY KIND, EXPRESS OR IMPLIED, INCLUDING BUT NOT LIMITED TO THE WARRANTIES OF MERCHANTABILITY, FITNESS FOR A PARTICULAR PURPOSE AND NONINFRINGEMENT.

IN NO EVENT SHALL THE AUTHORS OR COPYRIGHT HOLDERS BE LIABLE FOR ANY CLAIM, DAMAGES OR OTHER LIABILITY, WHETHER IN AN ACTION OF CONTRACT, TORT OR OTHERWISE, ARISING FROM, OUT OF OR IN CONNECTION WITH THE SOFTWARE OR THE USE OR OTHER DEALINGS IN THE SOFTWARE.

❑ getopt

<http://cvsweb.netbsd.org/bsdweb.cgi/src/lib/libc/stdlib/>

Copyright (c) 1987, 1993, 1994 The Regents of the University of California. All rights reserved.

Redistribution and use in source and binary forms, with or without modification, are permitted provided that the following conditions are met:

1. Redistributions of source code must retain the above copyright notice, this list of conditions and the following disclaimer.
2. Redistributions in binary form must reproduce the above copyright notice, this list of conditions and the following disclaimer in the documentation and/or other materials provided with the distribution.
3. Neither the name of the University nor the names of its contributors may be used to endorse or promote products derived from this software without specific prior written permission.

THIS SOFTWARE IS PROVIDED BY THE REGENTS AND CONTRIBUTORS "AS IS" AND ANY EXPRESS OR IMPLIED WARRANTIES, INCLUDING, BUT NOT LIMITED TO, THE IMPLIED WARRANTIES OF MERCHANTABILITY AND FITNESS FOR A PARTICULAR PURPOSE ARE DISCLAIMED. IN NO EVENT SHALL THE REGENTS OR CONTRIBUTORS BE LIABLE FOR ANY DIRECT, INDIRECT, INCIDENTAL, SPECIAL, EXEMPLARY, OR CONSEQUENTIAL DAMAGES (INCLUDING, BUT NOT LIMITED TO, PROCUREMENT OF SUBSTITUTE GOODS OR SERVICES; LOSS OF USE, DATA, OR PROFITS; OR BUSINESS INTERRUPTION) HOWEVER CAUSED AND ON ANY THEORY OF LIABILITY, WHETHER IN CONTRACT, STRICT LIABILITY, OR TORT (INCLUDING NEGLIGENCE OR OTHERWISE) ARISING IN ANY WAY OUT OF THE USE OF THIS SOFTWARE, EVEN IF ADVISED OF THE POSSIBILITY OF SUCH DAMAGE.

❑ jQuery

Copyright 2014 jQuery Foundation and other contributors

<http://jquery.com/>

Permission is hereby granted, free of charge, to any person obtaining a copy of this software and associated documentation files (the "Software"), to deal in the Software without restriction, including without limitation the rights to use, copy, modify, merge, publish, distribute, sublicense, and/or sell copies of the Software, and to permit persons to whom the Software is furnished to do so, subject to the following conditions:

The above copyright notice and this permission notice shall be included in all copies or substantial portions of the Software.

THE SOFTWARE IS PROVIDED "AS IS", WITHOUT WARRANTY OF ANY KIND, EXPRESS OR IMPLIED, INCLUDING BUT NOT LIMITED TO THE WARRANTIES OF MERCHANTABILITY, FITNESS FOR A PARTICULAR PURPOSE AND NONINFRINGEMENT. IN NO EVENT SHALL THE AUTHORS OR COPYRIGHT HOLDERS BE LIABLE FOR ANY CLAIM, DAMAGES OR OTHER LIABILITY, WHETHER IN AN ACTION OF CONTRACT, TORT OR OTHERWISE, ARISING FROM, OUT OF OR IN CONNECTION WITH THE SOFTWARE OR THE USE OR OTHER DEALINGS IN THE SOFTWARE.

❑ libpcap-1.4.0

License: BSD

Redistribution and use in source and binary forms, with or without modification, are permitted provided that the following conditions are met:

1. Redistributions of source code must retain the above copyright notice, this list of conditions and the following disclaimer.
2. Redistributions in binary form must reproduce the above copyright notice, this list of conditions and the following disclaimer in the documentation and/or other materials provided with the distribution.
3. The names of the authors may not be used to endorse or promote products derived from this software without specific prior written permission.

THIS SOFTWARE IS PROVIDED “AS IS” AND WITHOUT ANY EXPRESS OR IMPLIED WARRANTIES, INCLUDING, WITHOUT LIMITATION, THE IMPLIED WARRANTIES OF MERCHANTABILITY AND FITNESS FOR A PARTICULAR PURPOSE.

❑ libtar-1.2.11

Copyright (c) 1998-2003 University of Illinois Board of Trustees

Copyright (c) 1998-2003 Mark D. Roth

All rights reserved.

Developed by: Campus Information Technologies and Educational Services, University of Illinois at Urbana-Champaign

Permission is hereby granted, free of charge, to any person obtaining a copy of this software and associated documentation files (the “Software”), to deal with the Software without restriction, including without limitation the rights to use, copy, modify, merge, publish, distribute, sublicense, and/or sell copies of the Software, and to permit persons to whom the Software is furnished to do so, subject to the following conditions:

- * Redistributions of source code must retain the above copyright notice, this list of conditions and the following disclaimers.
- * Redistributions in binary form must reproduce the above copyright notice, this list of conditions and the following disclaimers in the documentation and/or other materials provided with the distribution.
- * Neither the names of Campus Information Technologies and Educational Services, University of Illinois at Urbana-Champaign, nor the names of its contributors may be used to endorse or promote products derived from this Software without specific prior written permission.

THE SOFTWARE IS PROVIDED “AS IS”, WITHOUT WARRANTY OF ANY KIND, EXPRESS OR IMPLIED, INCLUDING BUT NOT LIMITED TO THE WARRANTIES OF MERCHANTABILITY, FITNESS FOR A PARTICULAR PURPOSE AND NONINFRINGEMENT.

IN NO EVENT SHALL THE CONTRIBUTORS OR COPYRIGHT HOLDERS BE LIABLE FOR ANY CLAIM, DAMAGES OR OTHER LIABILITY, WHETHER IN AN ACTION OF CONTRACT, TORT OR OTHERWISE, ARISING FROM, OUT OF OR IN CONNECTION WITH THE SOFTWARE OR THE USE OR OTHER DEALINGS WITH THE SOFTWARE.

❑ mDNS 320.10.80

The majority of the source code in the mDNSResponder project is licensed under the terms of the Apache License, Version 2.0, available from:

<<http://www.apache.org/licenses/LICENSE-2.0>>

To accommodate license compatibility with the widest possible range of client code licenses, the shared library code, which is linked at runtime into the same address space as the client using it, is licensed under the terms of the “Three-Clause BSD License”.

The Linux Name Service Switch code, contributed by National ICT Australia Ltd (NICTA) is licensed under the terms of the NICTA Public Software Licence (which is substantially similar to the “Three-Clause BSD License”, with some additional language pertaining to Australian law).

❑ mongoose

<https://github.com/cesanta/mongoose/>

Copyright (c) 2004-2013 Sergey Lyubka

Permission is hereby granted, free of charge, to any person obtaining a copy of this software and associated documentation files (the “Software”), to deal in the Software without restriction, including without limitation the rights to use, copy, modify, merge, publish, distribute, sublicense, and/or sell copies of the Software, and to permit persons to whom the Software is furnished to do so, subject to the following conditions:

The above copyright notice and this permission notice shall be included in all copies or substantial portions of the Software.

THE SOFTWARE IS PROVIDED “AS IS”, WITHOUT WARRANTY OF ANY KIND, EXPRESS OR IMPLIED, INCLUDING BUT NOT LIMITED TO THE WARRANTIES OF MERCHANTABILITY, FITNESS FOR A PARTICULAR PURPOSE AND NONINFRINGEMENT. IN NO EVENT SHALL THE AUTHORS OR COPYRIGHT HOLDERS BE LIABLE FOR ANY CLAIM, DAMAGES OR OTHER LIABILITY, WHETHER IN AN ACTION OF CONTRACT, TORT OR OTHERWISE, ARISING FROM, OUT OF OR IN CONNECTION WITH THE SOFTWARE OR THE USE OR OTHER DEALINGS IN THE SOFTWARE.

❑ openssl-1.0.0d

Copyright (c) 1998-2011 The OpenSSL Project. All rights reserved.

Redistribution and use in source and binary forms, with or without modification, are permitted provided that the following conditions are met:

1. Redistributions of source code must retain the above copyright notice, this list of conditions and the following disclaimer.
2. Redistributions in binary form must reproduce the above copyright notice, this list of conditions and the following disclaimer in the documentation and/or other materials provided with the distribution.
3. All advertising materials mentioning features or use of this software must display the following acknowledgment:
“This product includes software developed by the OpenSSL Project for use in the OpenSSL Toolkit. (<http://www.openssl.org/>)”
4. The names “OpenSSL Toolkit” and “OpenSSL Project” must not be used to endorse or promote products derived from this software without prior written permission. For written permission, please contact openssl-core@openssl.org.
5. Products derived from this software may not be called “OpenSSL” nor may “OpenSSL” appear in their names without prior written permission of the OpenSSL Project.
6. Redistributions of any form whatsoever must retain the following acknowledgment:
“This product includes software developed by the OpenSSL Project for use in the OpenSSL Toolkit (<http://www.openssl.org/>)”

THIS SOFTWARE IS PROVIDED BY THE OpenSSL PROJECT “AS IS” AND ANY EXPRESSED OR IMPLIED WARRANTIES, INCLUDING, BUT NOT LIMITED TO, THE IMPLIED WARRANTIES OF MERCHANTABILITY AND FITNESS FOR A PARTICULAR PURPOSE ARE DISCLAIMED. IN NO EVENT SHALL THE OpenSSL PROJECT OR ITS CONTRIBUTORS BE LIABLE FOR ANY DIRECT, INDIRECT, INCIDENTAL, SPECIAL, EXEMPLARY, OR CONSEQUENTIAL DAMAGES (INCLUDING, BUT NOT LIMITED TO, PROCUREMENT OF SUBSTITUTE GOODS OR SERVICES; LOSS OF USE, DATA, OR PROFITS; OR BUSINESS INTERRUPTION) HOWEVER CAUSED AND ON ANY THEORY OF LIABILITY, WHETHER IN CONTRACT, STRICT LIABILITY, OR TORT (INCLUDING NEGLIGENCE OR OTHERWISE) ARISING IN ANY WAY OUT OF THE USE OF THIS SOFTWARE, EVEN IF ADVISED OF THE POSSIBILITY OF SUCH DAMAGE.

This product includes cryptographic software written by Eric Young (eay@cryptsoft.com). This product includes software written by Tim Hudson (tjh@cryptsoft.com).



❑ portmap-6.0

Copyright (c) 1990 The Regents of the University of California.

- * All rights reserved.
- * Redistribution and use in source and binary forms, with or without modification, are permitted provided that the following conditions are met:
 1. Redistributions of source code must retain the above copyright notice, this list of conditions and the following disclaimer.
 2. Redistributions in binary form must reproduce the above copyright notice, this list of conditions and the following disclaimer in the documentation and/or other materials provided with the distribution.
 3. A ll advertising materials mentioning features or use of this software must display the following acknowledgement:
This product includes software developed by the University of California, Berkeley and its contributors.
 4. Neither the name of the University nor the names of its contributors may be used to endorse or promote products derived from this software without specific prior written permission.
- * THIS SOFTWARE IS PROVIDED BY THE REGENTS AND CONTRIBUTORS "AS IS" AND ANY EXPRESS OR IMPLIED WARRANTIES, INCLUDING, BUT NOT LIMITED TO, THE IMPLIED WARRANTIES OF MERCHANTABILITY AND FITNESS FOR A PARTICULAR PURPOSE ARE DISCLAIMED. IN NO EVENT SHALL THE REGENTS OR CONTRIBUTORS BE LIABLE FOR ANY DIRECT, INDIRECT, INCIDENTAL, SPECIAL, EXEMPLARY, OR CONSEQUENTIAL DAMAGES (INCLUDING, BUT NOT LIMITED TO, PROCUREMENT OF SUBSTITUTE GOODS OR SERVICES; LOSS OF USE, DATA, OR PROFITS; OR BUSINESS INTERRUPTION) HOWEVER CAUSED AND ON ANY THEORY OF LIABILITY, WHETHER IN CONTRACT, STRICT LIABILITY, OR TORT (INCLUDING NEGLIGENCE OR OTHERWISE) ARISING IN ANY WAY OUT OF THE USE OF THIS SOFTWARE, EVEN IF ADVISED OF THE POSSIBILITY OF SUCH DAMAGE.

❑ pstdint.h-0.1.12

- * BSD License:
- * Copyright (c) 2005-2011 Paul Hsieh
- * All rights reserved.
- * Redistribution and use in source and binary forms, with or without modification, are permitted provided that the following conditions are met:
 1. Redistributions of source code must retain the above copyright notice, this list of conditions and the following disclaimer.
 2. Redistributions in binary form must reproduce the above copyright notice, this list of conditions and the following disclaimer in the documentation and/or other materials provided with the distribution.
 3. The name of the author may not be used to endorse or promote products derived from this software without specific prior written permission.
- * THIS SOFTWARE IS PROVIDED BY THE AUTHOR "AS IS" AND ANY EXPRESS OR IMPLIED WARRANTIES, INCLUDING, BUT NOT LIMITED TO, THE IMPLIED WARRANTIES OF MERCHANTABILITY AND FITNESS FOR A PARTICULAR PURPOSE ARE DISCLAIMED.
- * IN NO EVENT SHALL THE AUTHOR BE LIABLE FOR ANY DIRECT, INDIRECT, INCIDENTAL, SPECIAL, EXEMPLARY, OR CONSEQUENTIAL DAMAGES (INCLUDING, BUT NOT LIMITED TO, PROCUREMENT OF SUBSTITUTE GOODS OR SERVICES; LOSS OF USE, DATA, OR PROFITS; OR BUSINESS INTERRUPTION) HOWEVER CAUSED AND ON ANY THEORY OF LIABILITY, WHETHER IN CONTRACT, STRICT LIABILITY, OR TORT (INCLUDING NEGLIGENCE OR OTHERWISE) ARISING IN ANY WAY OUT OF THE USE OF THIS SOFTWARE, EVEN IF ADVISED OF THE POSSIBILITY OF SUCH DAMAGE.



❑ **rl78flash 2000.3.1**

License

=====

The MIT License (MIT)

Copyright (c) 2012 Maxim Salov

Permission is hereby granted, free of charge, to any person obtaining a copy of this software and associated documentation files (the "Software"), to deal in the Software without restriction, including without limitation the rights to use, copy, modify, merge, publish, distribute, sublicense, and/or sell copies of the Software, and to permit persons to whom the Software is furnished to do so, subject to the following conditions:

The above copyright notice and this permission notice shall be included in all copies or substantial portions of the Software.

THE SOFTWARE IS PROVIDED "AS IS", WITHOUT WARRANTY OF ANY KIND, EXPRESS OR IMPLIED, INCLUDING BUT NOT LIMITED TO THE WARRANTIES OF MERCHANTABILITY, FITNESS FOR A PARTICULAR PURPOSE AND NONINFRINGEMENT. IN NO EVENT SHALL THE AUTHORS OR COPYRIGHT HOLDERS BE LIABLE FOR ANY CLAIM, DAMAGES OR OTHER LIABILITY, WHETHER IN AN ACTION OF CONTRACT, TORT OR OTHERWISE, ARISING FROM, OUT OF OR IN CONNECTION WITH THE SOFTWARE OR THE USE OR OTHER DEALINGS IN THE SOFTWARE.

❑ **sqlite 2003.5.7**

SQLite Copyright

SQLite is in the
Public Domain

All of the code and documentation in SQLite has been dedicated to the public domain by the authors. All code authors, and representatives of the companies they work for, have signed affidavits dedicating their contributions to the public domain and originals of those signed affidavits are stored in a firesafe at the main offices of Hwaci. Anyone is free to copy, modify, publish, use, compile, sell, or distribute the original SQLite code, either in source code form or as a compiled binary, for any purpose, commercial or non-commercial, and by any means.

The previous paragraph applies to the deliverable code and documentation in SQLite - those parts of the SQLite library that you actually bundle and ship with a larger application. Some scripts used as part of the build process (for example the "configure" scripts generated by autoconf) might fall under other open-source licenses. Nothing from these build scripts ever reaches the final deliverable SQLite library, however, and so the licenses associated with those scripts should not be a factor in assessing your rights to copy and use the SQLite library.

All of the deliverable code in SQLite has been written from scratch. No code has been taken from other projects or from the open internet. Every line of code can be traced back to its original author, and all of those authors have public domain dedications on file. So the SQLite code base is clean and is uncontaminated with licensed code from other projects.

❑ **strncpy.c , v1.11**

- * Copyright (c) 1998 Todd C. Miller <Todd.Miller@courtesan.com>
- * Permission to use, copy, modify, and distribute this software for any purpose with or without fee is hereby granted, provided that the above copyright notice and this permission notice appear in all copies.
- * THE SOFTWARE IS PROVIDED “AS IS” AND THE AUTHOR DISCLAIMS ALL WARRANTIES WITH REGARD TO THIS SOFTWARE INCLUDING ALL IMPLIED WARRANTIES OF MERCHANTABILITY AND FITNESS. IN NO EVENT SHALL THE AUTHOR BE LIABLE FOR ANY SPECIAL, DIRECT, INDIRECT, OR CONSEQUENTIAL DAMAGES OR ANY DAMAGES WHATSOEVER RESULTING FROM LOSS OF USE, DATA OR PROFITS, WHETHER IN AN ACTION OF CONTRACT, NEGLIGENCE OR OTHER TORTIOUS ACTION, ARISING OUT OF OR IN CONNECTION WITH THE USE OR PERFORMANCE OF THIS SOFTWARE.

❑ **taglib-1.5**

copyright : (C) 2002 - 2008 by Scott Wheeler
email : wheeler@kde.org

“The contents of this file are subject to the Mozilla Public License Version 1.1 (the “License”); you may not use this file except in compliance with the License. You may obtain a copy of the License at <http://www.mozilla.org/MPL/>

Software distributed under the License is distributed on an “AS IS” basis, WITHOUT WARRANTY OF ANY KIND, either express or implied. See the License for the specific language governing rights and limitations under the License.

❑ **tinycl 2002.4.3**

www.sourceforge.net/projects/tinycl

Original file by Yves Berquin.

This software is provided 'as-is', without any express or implied warranty. In no event will the authors be held liable for any damages arising from the use of this software.

Permission is granted to anyone to use this software for any purpose, including commercial applications, and to alter it and redistribute it freely, subject to the following restrictions:

1. The origin of this software must not be misrepresented; you must not claim that you wrote the original software. If you use this software in a product, an acknowledgment in the product documentation would be appreciated but is not required.
2. Altered source versions must be plainly marked as such, and must not be misrepresented as being the original software.
3. This notice may not be removed or altered from any source distribution.



❑ Tremor

<http://wiki.xiph.org/index.php/Tremor>

Copyright (c) 2002, Xiph.org Foundation

Redistribution and use in source and binary forms, with or without modification, are permitted provided that the following conditions are met:

1. Redistributions of source code must retain the above copyright notice, this list of conditions and the following disclaimer.
2. Redistributions in binary form must reproduce the above copyright notice, this list of conditions and the following disclaimer in the documentation and/or other materials provided with the distribution.
3. Neither the name of the Xiph.org Foundation nor the names of its contributors may be used to endorse or promote products derived from this software without specific prior written permission.

THIS SOFTWARE IS PROVIDED BY THE COPYRIGHT HOLDERS AND CONTRIBUTORS "AS IS" AND ANY EXPRESS OR IMPLIED WARRANTIES, INCLUDING, BUT NOT LIMITED TO, THE IMPLIED WARRANTIES OF MERCHANTABILITY AND FITNESS FOR A PARTICULAR PURPOSE ARE DISCLAIMED. IN NO EVENT SHALL THE FOUNDATION OR CONTRIBUTORS BE LIABLE FOR ANY DIRECT, INDIRECT, INCIDENTAL, SPECIAL, EXEMPLARY, OR CONSEQUENTIAL DAMAGES (INCLUDING, BUT NOT LIMITED TO, PROCUREMENT OF SUBSTITUTE GOODS OR SERVICES; LOSS OF USE, DATA, OR PROFITS; OR BUSINESS INTERRUPTION) HOWEVER CAUSED AND ON ANY THEORY OF LIABILITY, WHETHER IN CONTRACT, STRICT LIABILITY, OR TORT (INCLUDING NEGLIGENCE OR OTHERWISE) ARISING IN ANY WAY OUT OF THE USE OF THIS SOFTWARE, EVEN IF ADVISED OF THE POSSIBILITY OF SUCH DAMAGE.

❑ zlib

<http://www.zlib.net/>

zlib.h -- interface of the 'zlib' general purpose compression library version 1.2.3, July 18th, 2005

Copyright (C) 1995-2004 Jean-loup Gailly and Mark Adler

This software is provided 'as-is', without any express or implied warranty. In no event will the authors be held liable for any damages arising from the use of this software.

Permission is granted to anyone to use this software for any purpose, including commercial applications, and to alter it and redistribute it freely, subject to the following restrictions:

1. The origin of this software must not be misrepresented; you must not claim that you wrote the original software. If you use this software in a product, an acknowledgment in the product documentation would be appreciated but is not required.
2. Altered source versions must be plainly marked as such, and must not be misrepresented as being the original software.
3. This notice may not be removed or altered from any source distribution.

Jean-loup Gailly jloup@gzip.org, Mark Adler
madler@alumni.caltech.edu

- ❑ **The Spotify software is subject to third party licenses found here:**

www.spotify.com/connect/third-party-licenses

DENON®

HEOSbyDenon.com

3520 10545 00AD

Copyright © 2017 D&M Holdings Inc. All Rights Reserved.