



# Uninterruptible Power Supply Three-Phase User Manual



**UPS-33020-02, UPS-33030-12, UPS-33040-12**

## TABLE OF CONTENTS

<b>1.0</b>	<b>Safety and EMC Instructions</b> .....	<b>6</b>
<b>2.0</b>	<b>Installation</b> .....	<b>11</b>
<b>3.0</b>	<b>Operation</b> .....	<b>21</b>
<b>4.0</b>	<b>Troubleshooting</b> .....	<b>58</b>
<b>5.0</b>	<b>Storage and Maintenance</b> .....	<b>60</b>
<b>6.0</b>	<b>Specifications</b> .....	<b>62</b>

**IMPORTANT SAFETY INSTRUCTIONS**

This manual contains important instructions to be followed during installation and maintenance of the UPS and batteries.

Please read all instructions before installing or operating the described equipment and **PLEASE SAVE THIS MANUAL FOR FUTURE REFERENCE!**

**SPECIAL SYMBOLS:** The following are examples of symbols used on the UPS, or within this manual to alert you to important information. Please familiarize yourself with these symbols.



**Risk of Electric Shock**—Observe the warnings associated with the risk of electrical shock.



**CAUTION: HOT SURFACE**—Do not touch! Risk of burn hazard.



**CAUTION: REFER TO OPERATOR'S MANUAL**—Refer to the operator's manual for additional information, such as specific operating and/or maintenance instructions.

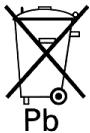

**Do Not Discard**—This equipment utilizes components that contain lead and must be disposed of properly. For more information, contact your local recycling/refuse or hazardous waste center.



**Do Not Discard**—Never discard Waste Electrical or Electronic Equipment (WEEE) in the trash. For proper disposal contact your local recycling/refuse or hazardous waste center.



**Information of Special Note**—Specific handling or operational instructions may apply.



**Phase**—This is the electrical symbol for the word “phase”.



**Recycle**—Equipment or components are made of recyclable material, please contact your local recycling center for proper disposal.

## NOTE TO USERS

To ensure correct operation of the UPS, please read this instruction manual carefully. Please keep this manual handy for future reference.

 <p><b>WARNING</b> ELECTRICAL HAZARD AUTHORIZED PERSONNEL ONLY</p>	<p>This UPS has dangerously high voltages on both its Input and output connections. Contact with these voltages may be life threatening. Please follow the operating instructions carefully. Please give close attention to the warnings in this manual and those posted on the UPS. There are no user serviceable parts inside the UPS. Disassembly and/or maintenance should only be done by authorized personnel.</p>
--	--

## IMPORTANT INFORMATION FOR USERS OF THIS UNINTERRUPTIBLE POWER SUPPLY

1. Before operating the UPS or connecting any load equipment, please ensure the UPS is connected to a properly grounded electrical supply.
2. This UPS has dangerously high voltages on both its input and output connections. Contact with these voltages may be life threatening.
3. Please do not disassemble the covers. There is a risk of electric shock.
4. In an emergency, immediately turn off the circuit breaker for the circuit supplying power to the UPS. Also immediately turn off the battery circuit breaker.
5. This UPS has two power sources. One is the circuit supplying the UPS with input power. The other is the UPS battery. Prior to any maintenance, both of these power sources must be disconnected to ensure that the UPS is de-energized. If only the input power is disconnected, the UPS can still operate from the battery, and hazardous voltages may still exist.

6. To prevent damage or a safety hazard, keep the UPS away from open flame and any other devices that may cause sparks.
7. Do not open or damage individual battery cases as spillage of caustic electrolyte may occur resulting in danger to life, safety, and the environment.
8. The charging characteristics of UPS batteries vary by both brand and type. For this reason, replacement batteries should be of the same brand and type as those specified by the manufacturer. Using batteries other than the brand and type specified by the manufacturer may affect the performance of the UPS. Before installing batteries of different brand or type, please consult with the manufacturer.
9. The UPS has an internal EMI filter for purposes of enhancing electromagnetic compatibility with the input mains supply. This filter produces leakage current to earth on the input mains. When selecting a circuit breaker for the branch circuit supplying power to the UPS, ensure that the breaker selected is not an ELCB type circuit breaker that detects earth leakage current.
10. Please contact the manufacturer or an authorized distributor for any assistance with troubleshooting.
11. The UPS should only be serviced or maintained by a factory authorized service technician.
12. This UPS meets FCC Class A electromagnetic compatibility requirements.
13. Depleted batteries must be disposed of in a proper manner. Contact your local recycling or hazardous waste center or the UPS manufacturer for instructions concerning proper disposal.

## 1.0 SAFETY AND EMC INSTRUCTIONS

All safety instructions in this document must be read, understood and followed.

### 1.1 Transportation and Storage

---

---

 **CAUTION**

---

Please transport the UPS system only in the original packaging to protect against shock and damage.

---

---

 **CAUTION**

---

The UPS must be stored in a room where the temperature is well regulated. Ambient temperature should not exceed 40°C.

---

### 1.2 Preparation

---

---

 **CAUTION**

---

Condensation may form if the UPS system is moved immediately from a cold to a warm environment. The UPS system must be completely dry before being installed. Please allow at least two hours for the UPS system to acclimate to the environment.

---

---

 **CAUTION**

---

Do not install the UPS system near water or in moist environments.

---

---

 **CAUTION**

---

Do not install the UPS system where it would be exposed to direct sunlight or nearby heat source.

---

---

 **CAUTION**

---

Do not block ventilation holes on the UPS housing.

---

### 1.3 Installation

---

 **CAUTION**

---

Do not connect appliances or devices which would overload the UPS (e.g. big motor-type equipment) to the UPS output terminal.

---

 **CAUTION**

---

Place cables in such a way that no one can step on or trip over them.

---

 **CAUTION**

---

Do not block air vents on the housing of the UPS. Ensure proper unit spacing of ventilation.

---

 **CAUTION**

---

UPS comes equipped with grounding terminal, in the final installation phase, connect grounding/earthing wire to the external UPS battery cabinets or appropriate grounding terminals.

---

 **CAUTION**

---

The UPS can be installed only by qualified maintenance personnel.

---

 **CAUTION**

---

An appropriate disconnect device such as short-circuit backup protection should be incorporated during installation.

---

 **CAUTION**

---

An integral emergency shutoff switch which prevents additional load from the UPS in any mode of operation should be implemented during the installation.

---

 **CAUTION**

---

Secure the grounding/earthing wire before connecting to any live wire terminal

---



---

 **CAUTION**

---

Installation and wiring must be in accordance with the local electrical laws and regulations.

---

**1.4 Connection**

---

 **WARNING**

---

In accordance with safety standard, installation must include a Backfeed Protection system, for example a contactor, which will prevent the appearance of voltage or dangerous energy in the input mains during a mains fault. There is no standard Backfeed Protection inside of the UPS. However, there are relays on the Input to cut-off line voltage while the neutral is still connected to UPS.

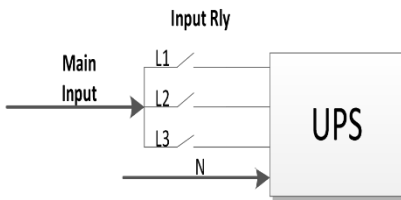

*Input Relay Diagram*

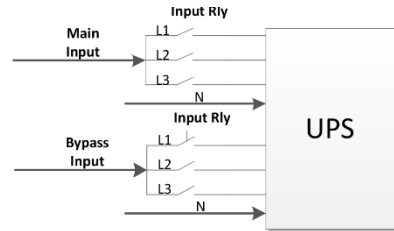

*Input Relay Diagram for Dual-Input Model*

- There can be no derivation in the line that goes from the Backfeed Protection to the UPS, as the standard safety would be infringed.
- Warning labels should be placed on all primary power switches installed in places away from the unit to alert the electrical maintenance personnel of the presence of a UPS in the circuit. The label will bear the following or an equivalent text:

**Before working on this circuit**

Isolate Uninterruptible Power Supply (UPS)

Check for Hazardous Voltage between all terminals including the protected earth.



**Risk of Voltage Backfeed!**

- The power input for this unit must be three-phase rated in accordance with the equipment nameplate. It also must be suitably grounded.

---

** WARNING: HIGH LEAKAGE CURRENT!**

---

**EARTH CONNECTION IS ESSENTIAL BEFORE CONNECT SUPPLY VOLTAGE**

- This UPS should be connected with a TN grounding/earthing system.
- Use of this equipment in a medical instrument or any life-sustaining equipment where failure of this equipment can reasonably be expected to cause the failure of the life-sustaining equipment, or significantly affect its safety or effectiveness, is not recommended. Do not use this equipment in the presence of a flammable mixture with air, oxygen or nitrous oxide.
- Connect grounding terminal of UPS to a grounding electrode conductor.

---

## 1.5 Operation

---

** CAUTION**

---

Do not disconnect the grounding/earthing conductor cable on the UPS or the building wiring terminals under any circumstance.

---

** CAUTION**

---

The UPS system features its own internal current source (batteries). The UPS output sockets or output terminal blocks may be electrically live even if the UPS system is not connected to the building mains/live wires (standard models only).

---

** CAUTION**

---

In order to fully disconnect the UPS system, first press the “OFF” button and then disconnect the mains/live wires.

---

** CAUTION**

---

Ensure that no liquid or other foreign objects can enter into the UPS system.

---

** CAUTION**

---

The UPS can be operated by any individual; no previous experience is required.

---

**1.6 Standards**

<b>* Safety</b>	
UL 1778, CSA C22.2 No.107.3-14	
<b>* EMI</b>	
Conducted Emission.....: FCC Part 15, Subpart B	Class A
Radiated Emission.....: FCC Part 15, Subpart B	Class A

---

**NOTE:**

This equipment has been tested and found to comply with the limits for a Class A digital device, pursuant to part 15 of the FCC Rules. These limits are designed to provide reasonable protection against harmful interference when the equipment is operated in a commercial environment. This equipment generates, uses, and can radiate radio frequency energy, and if not installed and used in accordance with the instruction manual, may cause harmful interference to radio communications. Operation of this equipment in a residential area is likely to cause harmful interference in which case the user will be required to correct the interference at his own expense.

---

## 2.0 INSTALLATION

We offer optional parallel function upon request. The UPS with parallel function is called the “Parallel Model”. We have detailed installation and operation procedures of the Parallel Model in the following chapter.

### 2.1 Unpacking and Inspection

Unpack the package and check the package contents. The shipping package should contain:

- One UPS
- One User Manual

---

**NOTE:**

Before the installation, please inspect the unit for any physical damage and for all parts and accessories. If damage is found or parts/accessories are missing, do not turn on the unit and notify the carrier and SurgeX immediately. Please keep the original packaging for future use. It is recommended to keep each equipment and battery set in their original packaging because they have been designed to provide maximum protection during transportation and storage

---

### 2.2 UPS Floor Anchoring

---

**NOTE:**

The L-shaped floor anchoring brackets that secured the enclosure to the pallet during shipment may be used for a stand-alone UPS enclosure to enhance stability.

---

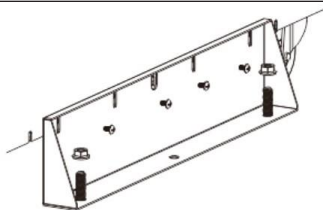

### 2.3 Wiring Terminal View

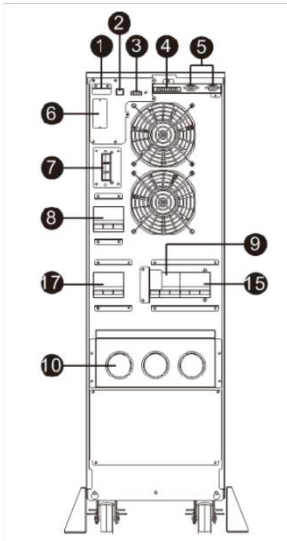

Diagram 1: 10kVA Rear Panel

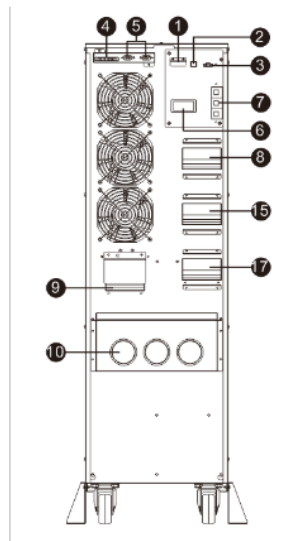

Diagram 2: 15kVA/20kVA Rear Panel

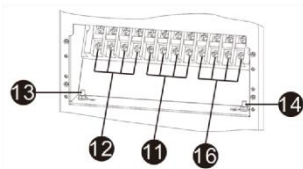

Diagram 3: 10kVA Input/Output Terminal

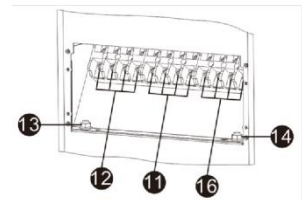

Diagram 4: 15K/20kVA Input/Output Terminal

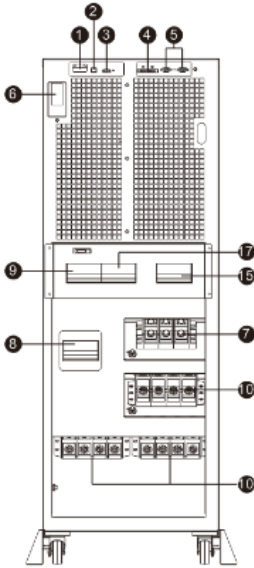

Diagram 5: 30kVA Front view with door open

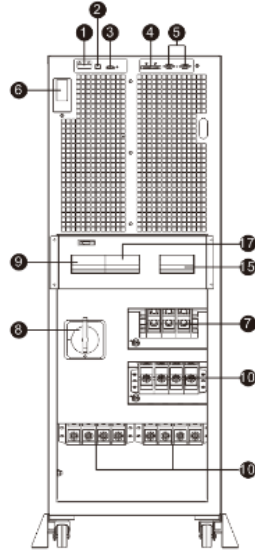

Diagram 6: 40kVA Front view with door open

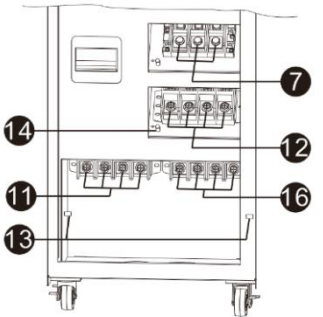

Diagram 7: 30kVA Input /Output Terminal

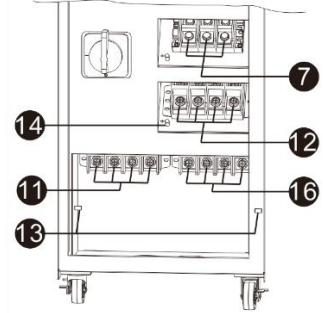
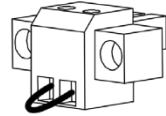

Diagram 8: 40kVA Input/Output Terminal

1. RS-232 communication port (only for firmware updates)
  2. USB communication port
  3. Emergency power off function connector (EPO connector)
- 

**NOTE:**

Keep the EPO connector closed for UPS normal operation. To activate EPO function, please remove the jumper.



- 
4. Share current port (only available for parallel model)
  5. Parallel port (only available for parallel model)
  6. Intelligent slot
  7. External battery connector (Only available for long-run model)
  8. Line input circuit breaker/switch
  9. Maintenance bypass switch
  10. Input/Output terminal (Refer to diagram 3 for the details)
  11. Line input terminal
  12. Output terminal
  13. Input grounding terminal
  14. Output grounding terminal
  15. Bypass input circuit breaker/switch
  16. Bypass input terminal
  17. Output circuit breaker

## 2.4 Operation Principle

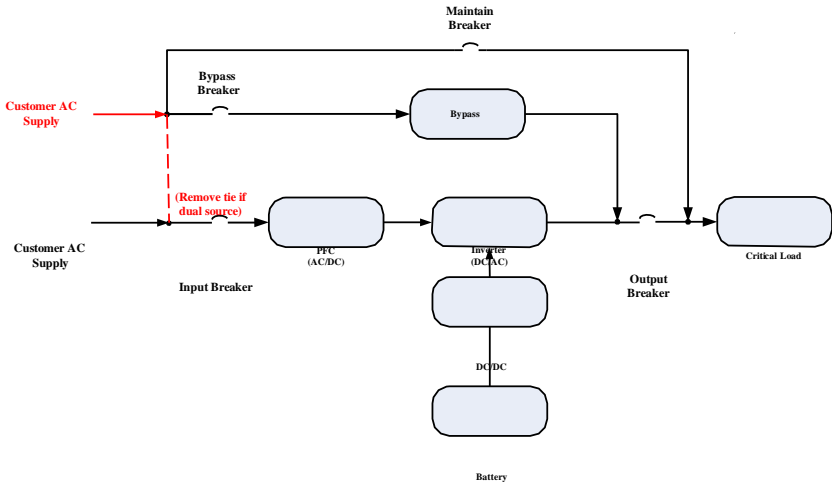

*The Operating Principle of the UPS*

## 2.5 Single UPS Installation

Installation and wiring must be carried out in accordance with the local electric laws and regulations by trained professionals.

1. Make sure that the mains wire and breakers of the building are rated for the capacity of the UPS to prevent electric shock or risk of fire. See Facility Data Planning Guide on page 47 for guidance.
2. Switch off the mains switch in the building before installation.
3. Turn off all connected devices before connecting to the UPS
4. Remove the terminal block cover at the rear panel of UPS.  
Then connect the wires according to the following terminal block diagrams.

(Connect the grounding/earthing wire first when making other wire connections. Remove the grounding/earthing wire last when connecting the UPS!)



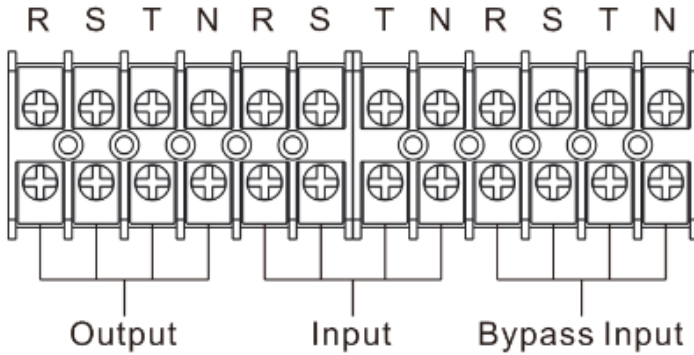

*Terminal Block Wiring Diagram for 10kVA*

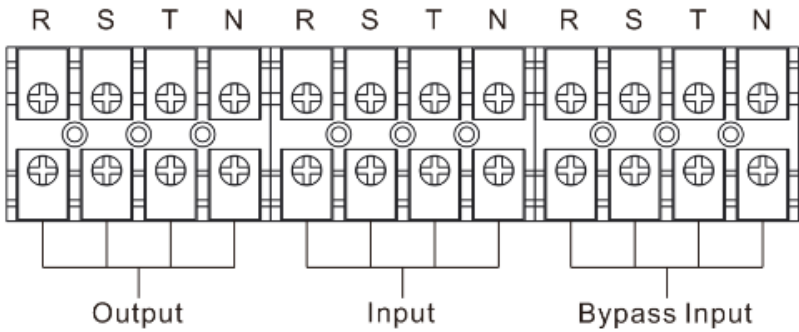

*Terminal Block Wiring Diagram for 15 / 20 KVA*

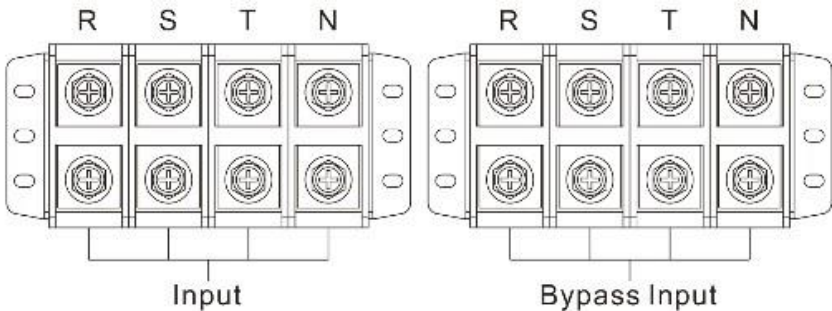

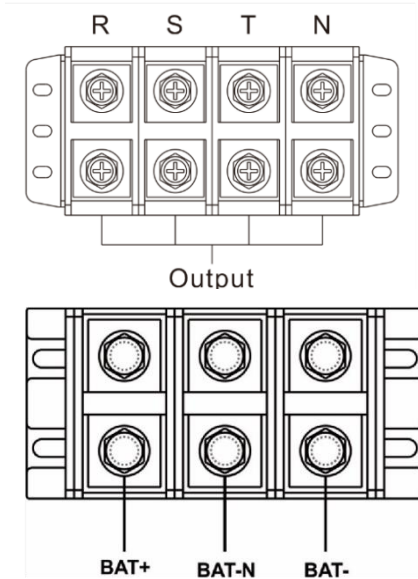

*Terminal Block Wiring Diagram for 30 / 40 KVA*

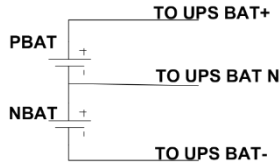

*Battery Connection Wiring*

**NOTE 1:** Make sure that the wires are connected securely with the terminals.

**NOTE 2:** Please install the output breaker between the output terminal and the load. The breaker should have leakage current protective function if necessary.

- Put the terminal block cover back at the rear panel of the UPS.

**WARNING (Standard Model Only)**

---

- Make sure the UPS is off before the installation. The UPS should not be turned on during wiring connection.
  - Do not attempt to modify the standard model into the long-run model. In particular, do not try to connect the standard internal battery to the external battery. The battery type and voltage may be different, risk of electric shock or fire may occur!
- 

**WARNING (Long Run Model Only)**

---

- Make sure a DC breaker or other protective device between UPS and the external battery pack is installed for added safety. If not, please install it carefully. Switch off the battery breaker before installation.

**NOTE:** Set the battery pack breaker in “OFF” position and then install the battery pack.

- Pay special attention to the rated battery voltage marked on the rear panel. If you want to change the numbers of the battery in a chain, make sure you modify the UPS setting accordingly. Connection with wrong battery voltage may cause irreversible damage of the UPS.
  - Pay special attention to the polarity marking on external battery terminal block. Connection with wrong battery voltage may cause irreversible damage of the UPS.
  - Make sure the protective grounding/earthing wiring is adequate. The current spec, color, position, connection and conductance reliability of the wire should be verified.
  - Make sure the utility input and output wiring are rated correctly. The current spec, color, position, connection and conductance reliability of the wire should be verified. Make sure the L/N side is correct, not reverse or short-circuited.
-

## 2.6 UPS Installation for Parallel System

If the UPS is only for single operation, you may skip this section.

1. Install and wire the UPS according to the section 2-5.
2. Connect the output wires of each UPS to an output breaker.
3. Connect all output breakers to a centralize breaker. This centralize output breaker will then connect directly to the loads.
4. Either common battery packs or independent battery packs for each UPS are allowed.
5. Refer to the following wiring diagram for input, output and bypass input:

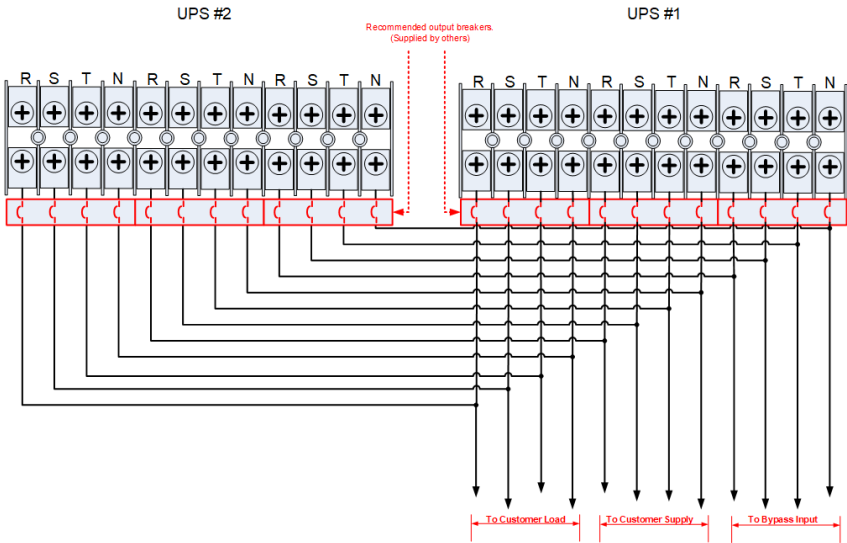

Wiring Diagram of Parallel System for 10 / 15 / 20 kVA

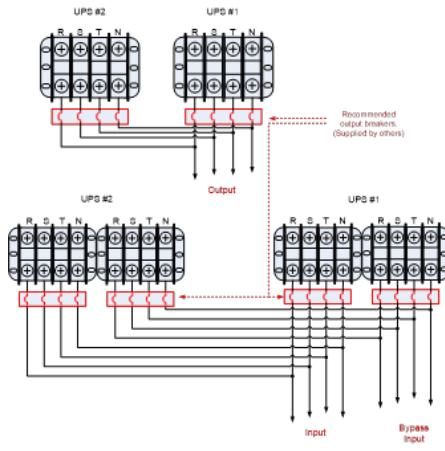

Wiring Diagram of Parallel System for 30 / 40 kVA

- Refer to the following communication wiring diagrams for shared Current cable and parallel cable connections.

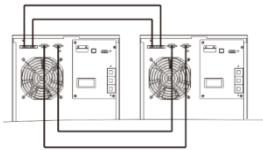

Diagram 1: Two UPSs in Parallel

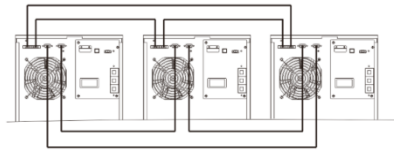

Diagram 2: Three UPSs in Parallel

### Parallel System for 10 / 15 / 20 kVA

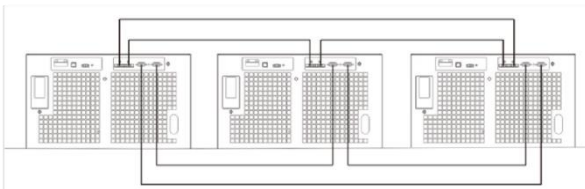

Diagram 1: Two UPSs in Parallel

Diagram 2: Three UPSs in Parallel

### Parallel System for 30 / 40 kVA

## 2.7 Software Installation

For optimal computer system protection, install UPS monitoring software to configure UPS shutdown operation.

## 3.0 OPERATION

### 3.1 Initial Operation

1. Before operation, make sure that the two strings of batteries are connected correctly in order of "+, GND, -" terminals and the breaker of the battery pack is at "ON" position (Long-run model only).
2. Press the " **POWER**" button to set up the power supply for the UPS. UPS will enter to power on mode. After initialization, UPS will enter to "No Output mode".

### 3.2 LED Indicators and LCD Panel

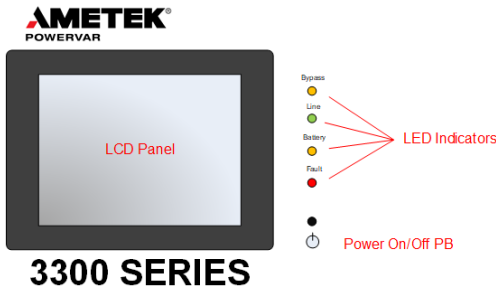

### LED Indicators

4 LEDs on the front panel show the UPS working status:

Mode	LED	Bypass	Line	Battery	Fault
UPS On		●	●	●	●
Standby mode		○	○	○	○
Bypass mode		●	○	○	○
Line mode		○	●	○	○
Battery mode		○	○	●	○
CVCF mode		○	●	○	○
Battery Test		●	●	●	○
ECO mode		●	●	○	○
Fault		○	○	○	●

Note: ● means LED is lighting, and ○ means LED is faded.

### 3.3 Screen Description

After initialization, the LCD will display the main screen. There are five sub-menus: control, measure, setting, information, and data log. Touch any sub-menu icon to enter the sub-screen.

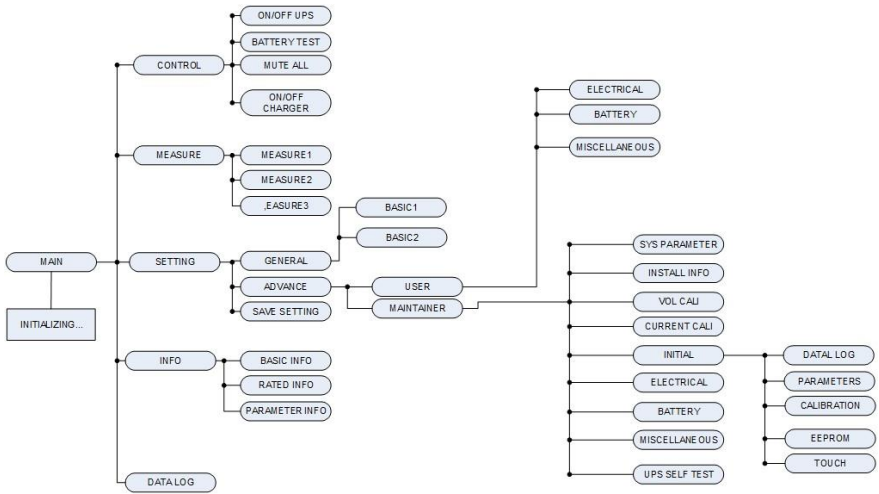

### 3.3.1 Main screen

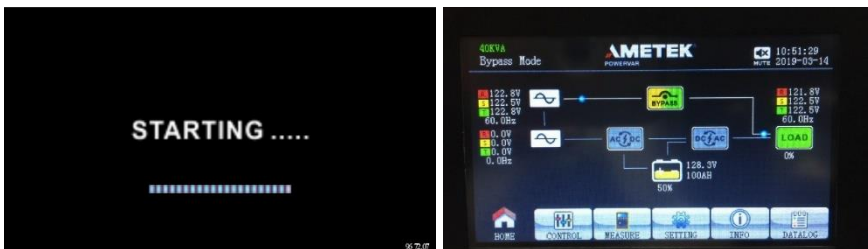

Upon powering on, the LCD will start initialization approximately few seconds as shown below.

After initialization, the main screen will display as shown below. On the bottom, there are five icons to represent five sub-menus: CONTROL, MEASURE, SETTING, INFO, DATALOG.

### 3.3.2 Control screen

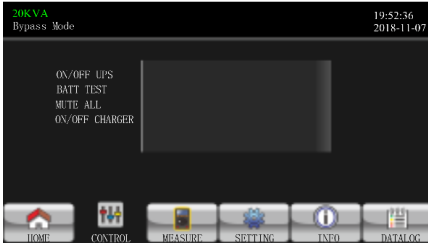

- Touch the icon to enter control sub-menu.
- Touch icon to return back to main screen from any screen.

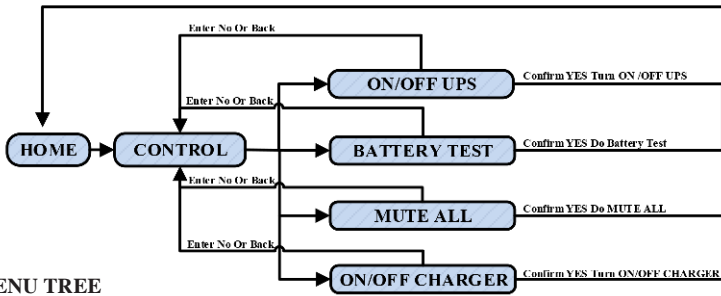

MENU TREE

Screen 1.0 «Control» and its Sub-Menus

#### h On/Off UPS



TURN ON UPS

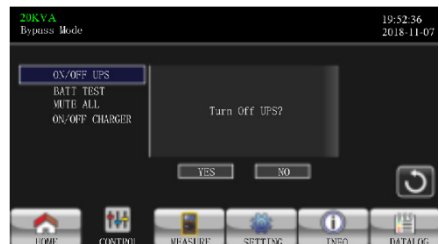

TURN OFF UPS

- It will show **Turn on UPS?** when UPS is off.
- It will show **Turn off UPS?** when UPS is on.
- Touch **YES** to turn the UPS on or off. The screen will return to the main screen.
- Touch **Back** to return to main screen immediately or **NO** to cancel this operation and go back to the main screen.



## ➤ Battery Test



**Battery Test**

**Cancel Battery Test**

- The unit will display “Battery Test” if the UPS is not in test mode. Touch **Yes** to start the battery test. “Battery testing...” will appear during the battery test period. After a few seconds, the battery test result will show on the screen. Touch **Back** to return to main screen immediately or **No** to cancel this operation and return to the main screen. “Cancel battery test” will appear if in test mode.

## ➤ Audio Mute



**Mute All**

**Cancel Mute All**

- The unit will display “Mute all” if the audio is active. Touch **Yes** to activate mute. If “Mute all” is active, the  icon on the top left corner of the main screen will appear. Touch **Back** to return to the CONTROL screen immediately or **No** to cancel this operation and return to the CONTROL screen.
- The unit will display “Cancel mute” if the UPS is already mute. Touch **Yes** activate audio function or **No** to keep mute. Touch **Back** to return to CONTROL screen.

## ➤ On/Off Charger

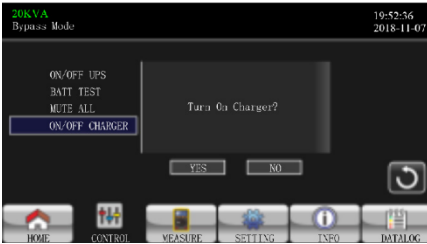

**TURN ON CHARGER**

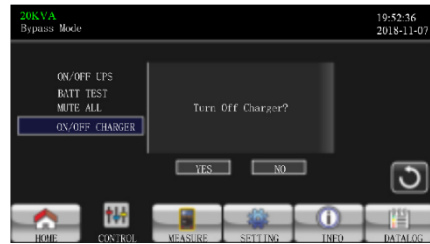

**TURN OFF CHARGER**

- The unit will display “**Turn on Charger?**” when the charger is off.
- The unit will display “**Turn off Charger?**” when the charger is on.
- Touch **Yes** to turn the charger on or off. The screen will return to the main screen.
- Touch **Back** to return to the CONTROL screen immediately or **No** to cancel this operation and return to CONTROL screen.

### 3.3.3 Measure Screen

- Touch the to enter measure page. Touch the or to browse information. Touch the to return to main screen. Touch the icon to go back to previous menu.

- **LINE VOL:** The real time value of R, S and T phase voltage, RS, ST, TR voltage and input frequency.
- **INVERTER VOL:** The real time value of R, S and T inverter voltage, RS, ST and TR voltage and frequency.
- **BYPASS VOL:** The real time value of R, S and T bypass voltage, RS, ST and TR voltage and frequency.
- **OUTPUT VOL:** The real time value of R, S T output voltage, RS, ST and TR voltage and frequency,

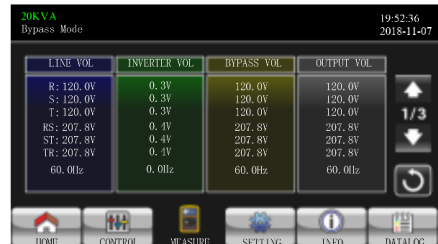

**Measure Screen Page 1**

- **OUTPUT W:** R, S and T output power in watt.
- **OUTPUT VA:** R, S and T output power in VA.
- **OUTPUT W (%):** R, S and T output power watt in percentage.
- **OUTPUT VA (%):** R, S and T output power VA in percentage.
- **Total watt and VA:** Total output load in watt and VA.
- **BATT Voltage/Bus Voltage/Charging Current/Discharging Current:** The real time value of DC related information.
- **Temperature:** Temperature of R, S and T phases.
- **INPUT W:** R, S and T input power in watt.
- **INPUT VA:** R, S and T input power in VA.
- **INPUT W (%):** R, S and T input power watt in percentage.
- **INPUT VA (%):** R, S and T input power VA in percentage.
- **Input current:** The real-time value of input current in R, S and T phases.
- **Output current:** The real-time value of output current in R, S and T phases.

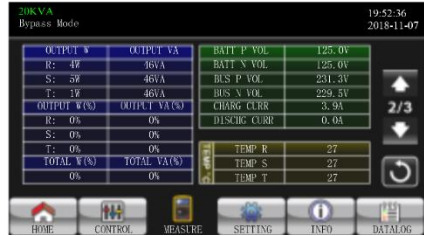

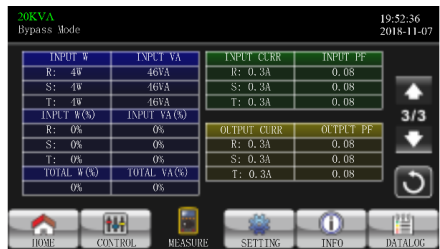

Measure Screen Page 2



Measure Screen Page 3

### 3.3.4 Setting screen

This sub-menu is used to set the parameters of the UPS. Touch  to enter setting menu page. There are 2 options: Basic and Advanced. Touch the  to return to main screen. Touch  to go back to previous menu.

#### NOTE:

Not all settings are available in every operation mode. If the setting is not available in present mode, the LCD will keep its original setting parameter showed instead of changing the parameters.

- **GENERAL:** It is to set up basic information of the UPS. It's not related to any function parameter.
- **ADVANCE:** It is required to enter password to access to the "ADVANCE" setting. There are two types of authority, User and Maintainer.
- **SAVE SETTING:** Select this function save the setting(s) when it is done. Click this tap to execute saving function no matter if UPS is connected to battery or not. However, it's requested to shut down the UPS to complete setting changes.

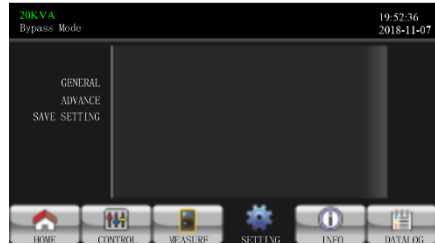

Setting Screen

## The Authority List:

SETTING ITEM	UPS OPERATION MODE	Standby Mode	Bypass Mode	Line Mode	Battery Mode	Battery Test Mode	Fault Mode	Converter Mode	ECO Mode	Authorization			
										Password No	User	Maintainer	
<b>GENERAL</b>	Date/Time	Y	Y	Y	Y	Y	Y	Y	Y	Y			
	Language	Y	Y	Y	Y	Y	Y	Y	Y	Y			
	Input Source	Y	Y							Y			
	Contact	Y	Y	Y	Y	Y	Y	Y	Y	Y			
	Phone	Y	Y	Y	Y	Y	Y	Y	Y	Y			
	Mail	Y	Y	Y	Y	Y	Y	Y	Y	Y			
	Audio Alarm	Y	Y	Y	Y	Y	Y	Y	Y	Y			
<b>ADVANCE</b>	Output Voltage	Y	Y								Y	Y	
	Output Frequency	Y	Y								Y	Y	
	CVCF Mode	Y	Y								Y	Y	
	Bypass Forbid	Y	Y	Y	Y	Y		Y	Y		Y	Y	
	Bypass Mode	Y	Y	Y	Y	Y		Y	Y		Y	Y	
	Bypass Voltage Range	Y	Y								Y	Y	
	Bypass Frequency Range	Y	Y								Y	Y	
	ECO Mode	Y	Y								Y	Y	
	ECO Voltage Range	Y	Y								Y	Y	
	ECO Frequency Range	Y	Y								Y	Y	
	<b>Battery</b>	Warning Voltage	Y	Y	Y	Y	Y		Y	Y		Y	Y
		Shutdown Voltage	Y	Y	Y	Y	Y		Y	Y		Y	Y
		Age Alert	Y	Y	Y	Y	Y		Y	Y		Y	Y
		Capacity in Ah	Y	Y	Y	Y	Y		Y	Y		Y	Y
	Auto Restarts	Y	Y	Y	Y	Y	Y	Y	Y		Y	Y	
	System Shutdown Time	Y	Y	Y	Y	Y	Y	Y	Y		Y	Y	
	System Restore Time	Y	Y	Y	Y	Y	Y	Y	Y		Y	Y	
Password Setting	Y	Y	Y	Y	Y	Y	Y	Y		Y	Y		
Default User Password	Y	Y	Y	Y	Y	Y	Y	Y			Y		
Model Name	Y	Y	Y	Y	Y	Y	Y	Y			Y		
Serial Number	Y	Y	Y	Y	Y	Y	Y	Y			Y		

SETTING ITEM	UPS OPERATION MODE	Standby Mode	Bypass Mode	Line Mode	Battery Mode	Battery Test Mode	Fault Mode	Converter Mode	ECO Mode	Auth		
										Password	User	Maintainer
ADVANCE	Manufacturers	Y	Y	Y	Y	Y	Y	Y	Y			Y
	Max. Charging Current	Y	Y	Y	Y	Y		Y	Y			Y
	Battery Numbers	Y	Y	Y	Y	Y		Y	Y			Y
	Charge Voltage	Y	Y	Y	Y	Y		Y	Y			Y
	Charger Numbers	Y	Y	Y	Y	Y		Y	Y			Y
	Float Voltage	Y	Y	Y	Y	Y		Y	Y			Y
	UPS Type	Y										
	System Install Date	Y	Y	Y	Y	Y	Y	Y	Y			Y
	Battery Install Date	Y	Y	Y	Y	Y	Y	Y	Y			Y
	Voltage Calibration			Y				Y				Y
	Current Calibration		Y	Y				Y				Y
	Clean Data Log	Y	Y	Y	Y	Y	Y	Y	Y			Y
	Reset Parameters	Y	Y									Y
	Reset Calibration	Y	Y									Y
	Reset EEPROM	Y	Y									Y
	Touch Calibration	Y	Y	Y	Y	Y	Y	Y	Y			Y
UPS Self Test				Y								Y
Save Setting	Y	Y								Y	Y	Y

“Y” means that this setting item can be set in this operation mode.

## GENERAL

- **Date/Time:** Set the date and time. The format is YYYY-MM-DD HH:MM:SS. The calendar day will be automatically changed when the year, month and date are set.
- **Language:** Set the LCD language. Only available in English.



General Screen Page 1

- **Input Source:** Select the input source. There are two options: Line (utility) and generator. Line is default setting. This setting value will show on the main page. When “generator” is selected, the acceptable input frequency will be fixed at the range of 40~75Hz. This setting value will show on the status bar.
- **Service Contact:** Set the name of contact person and the maximum length is 18 characters.
- **Service Phone:** Set the service phone number. Only 0~9, + and – are accepted. The maximum length is 14 characters.
- **Service Mail:** Set the service email accounts up to two and the maximum length is 36 characters.

- **Audio Alarm:** There are two events available to mute. You may choose Enable or Disable alarm when related events occur.

**Enable:** When selected, alarm will be mute when related events occur.

**Disable:** When selected, UPS will alarm when related events occur.



General Screen Page 2

- **All Mute:** When “enable” is selected, all the faults and warnings will be mute. It will show on the top right corner of the main screen.
- **Mode Mute:** UPS status mode alarm enable/disable. If “Mode Mute” is activated, it will show on the top right corner of the main screen.

## ADVANCE

A (4) digit password is required to access to the “ADVANCE” page.

- **ADVANCE > User**

- To access to the “Advance > User” Setting menu page, the default password is “0000”.
- If entered password is correct, the page will jump to the setting screen.
- If the password is not correct, the user will be asked to enter again.

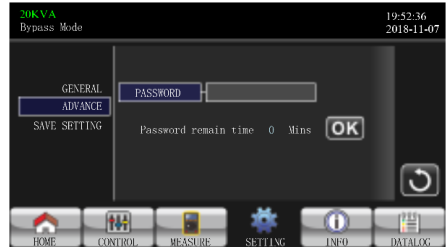

Advance Password Page



Password Error Page

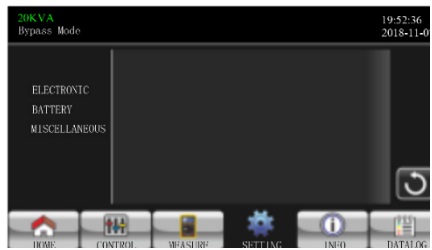

Advance Setting Menu Page

There are three sub-menus under “Advance >User” setting: ELECTRONIC, BATTERY and MISCELLANEOUS.

## ELECTRICAL

- **Output Voltage:** Select the output rated voltage. There are two options, 120V and 127V. 120Vac is the default setting.
- **Output Frequency:** Select output rated frequency.

**50Hz:** The output frequency is setting for 50Hz.

**60Hz:** The output frequency is setting for 60Hz.



Electrical Setting Page 1



- **CVCF Mode (constant voltage and constant frequency function)**
  - **Enable:** CVCF function is enabled. The output frequency will be fixed At 50Hz or 60Hz according to setting of “OP Freq.”. The input frequency can range from 40Hz to 70Hz.
  - **Disable:** CVCF function is disabled. The output frequency will synchronize with the bypass frequency within 45~55 Hz for 50Hz system or within 55~65 Hz for 60Hz system. Disable is the default setting.
- **Bypass Forbid:**
  - **Enable:** Bypass forbid is enabled. When selected, running in Bypass mode is not allowed under any situations.
  - **Disable:** Bypass forbid is disabled. When selected, UPS will run in Bypass mode depending on “Bypass at UPS off” setting. It is the default setting.

➤ **Bypass at UPS off:** Select the bypass status when manually turning off the UPS. This setting is only available when “Bypass forbid.” is set to “Disable”.



Electrical Setting Page 2

- **Enable:** When selected, bypass mode is activated.
- **Disable:** When selected, bypass is disabled and no output through bypass will occur when manually turning off the UPS.
- **Bypass Voltage Range:** Set the bypass voltage range.
- **L:** Low voltage point for bypass. The setting range is 96V ~ 110V. 96V is default setting.
- **H:** High voltage point for bypass. The setting range is 130V ~ 146V. 146V is default setting.
- **Bypass FRE Range:** Set the bypass frequency range. The acceptable bypass frequency ranges from 46Hz to 54Hz when the UPS is a 50Hz system and from 56Hz to 64Hz when UPS is a 60Hz system.
- **ECO mode:** Enable/Disable ECO mode. Default setting is “Disable”.

- **ECO Voltage Range:** Set the ECO voltage range.
  - **L:** Low voltage point for ECO mode. The setting ranges from “rated output voltage – 5V” to “Rated output voltage – 11V”. “Rated output voltage – 5V” is default setting.
  - **H:** High voltage point for ECO mode. The setting range is from “Rated output voltage + 5V” to “Rated output voltage + 11V”. “Rated output voltage + 5V” is default setting.
- **ECO FRE Range:** Set the ECO frequency range. The setting ranges from 46Hz to 54Hz when the UPS is a 50Hz system and from 56Hz to 64Hz when the UPS is a 60Hz system.

## BATTERY

### ➤ Battery Warning Voltage:

- **HIGH:** High battery warning voltage. The setting range is 14.0V ~ 15.0V. 14.4V is default setting.
- **LOW:** Low battery warning voltage. The setting range is 10.1V ~ 14.0V. 11.4V is default setting. This parameter setting is related to the “Shutdown Voltage” setting. This setting value should be higher than “Shutdown Voltage” setting.



- **Shutdown Voltage:** If battery voltage is lower than this point while in battery mode, the UPS will automatically shut down. The setting range is 10.0V ~ 12.0V. 10.7V is default setting (The setting is only available for long-run model).

### Battery Parameter:

- **Battery AH:** setting battery capacity. 9Ah is default setting.

## MISCELLANEOUS

- **Auto Restart:** (This function is reserved for future use)
  - Enable:** Once “Enable” is set, and the UPS shutdown occurs due to low battery and the utility restores, the UPS will return to line mode.
  - Disable:** Once “Disable” is set, and the UPS shutdown occurs and the utility restores, the UPS will not automatically turn on.

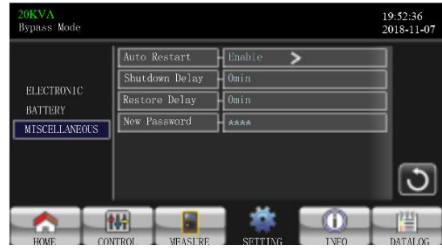

Miscellaneous Setting Page

- **Shutdown Delay Min:** UPS will shut down per delay minutes set. The countdown will start after confirming the pop-up screen.
- **Restore Delay Min:** UPS will automatically restart per restore delay minutes set after the UPS shuts down.
- **New Password:** Set up new password to enter “ADVANCE > User” menu.

- **ADVANCE > Maintainer**

To access the “Advance > Maintainer” Setting menu page, it’s required to enter password. Please contact your local dealer to get maintainer password.

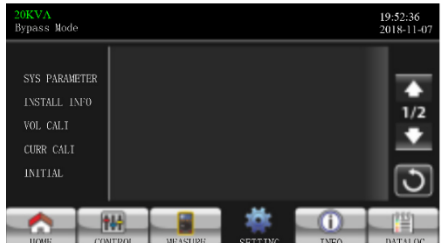

Advance: Maintainer Setting Menu Page1

### CAUTION

This setting menu is only for qualified technician. Otherwise, mis-operation will cause UPS damage.

There are five sub-menus under “Advance > Maintainer” setting: SYS PARAMETER, INSTALL INFO, VOL CALI, CURR CALI, INITIAL, ELECTRONIC, BATT, MISCELLANEOUS and UPS SELFTTEST.

## SYS PARAMETER

- **Mode Name:** Set the UPS model name.
- **Serial Number:** Set the serial number.
- **Manufacturer:** Set the UPS manufacturer.
- **Charger Number:** The number of charging boards installed in the UPS.



**SYS Parameter Page1**

### NOTE:

It's required to restart the UPS after setting.

- One piece of charger: When selected, there are four options available for “Max Charge CURR”.
- Two pieces of charger: When selected, there are two options available for “Max Charge CURR”.
- Three pieces of charger: When selected, there are three options available for “Max Charge CURR”.

- **Max Charge CURR:** The maximum of battery charging current. This parameter setting is related to “Charger Number” setting.

If UPS is 10K, 15K or 20K, the selectable charge current is listed below.

- One piece of charger: There are four options, 1A, 2A, 3A, 4A. 4A is default setting.
- Two pieces of charger: There are two options, 4A and 8A. 8A is default setting.
- Three pieces of charger: There are three options, 4A, 8A, 12A. 12A is default setting.
- Four pieces of charger: There are three options, 4A, 8A, 12A, 16A. 16A is default setting. (Only for 15K and 20K)
- Five pieces of charger: There are three options, 4A, 8A, 12A, 16A, 20A. 20A is default setting (Only 15K and 20K).

If UPS is 30K or 40K, the selectable charge current is listed below.

- One pair of charger: There are four options, 2A, 4A, 6A, 8A. 8A is default setting.
- Two pairs of charger: There are two options, 8A, 16A. 16A is default setting.
- Three pairs of charger: There are three options, 8A, 16A, 24A. 24A is default setting.

- **BATT Number:** The total number of installed battery. (It should restart UPS after setting.) The setting range is 8 ~ 10. 10 is default setting
- The setting point of battery float voltage. 13.6V is default setting.



**SYS Parameter Page 2**

- **UPS Type:** There are two options, HV and LV. This change is only allowed for qualified technician.

## NOTE:

It's required to restart the UPS after setting.

## INSTALL INFO

- **SYS Install Date:** Set the date of UPS installation.
- **BAT Install Date:** Set the date of Battery installation.



**Install Info Page**

## VOL CALI

- **Bus VOL:** BUS voltage calibration. Pressing the will increase or decrease the calibration by 0.1%, depending on if the up or down arrow is selected. Press “OK” key to confirm the modification.
- **BATT VOL:** Battery voltage calibration. Pressing the will increase or decrease the calibrate by 0.1%, depending on if the up or down arrow is selected. Press “OK” key to confirm the modification.
- **Line VOL:** Line voltage calibration. Pressing the will increase or decrease the calibration by 0.1%, depending on if the up or down arrow is selected. Press “OK” key to confirm the modification.
- **Output VOL:** Output voltage calibration. Pressing the will increase or decrease the calibration by 0.1%, depending on if the up or down arrow is selected. Press “OK” key to confirm the modification.
- **Inverter VOL:** Inverter voltage calibration. Pressing the will increase or decrease the calibration by 0.1%, depending on if the up or down arrow is selected. Press “OK” key to confirm the modification.
- **Bypass VOL:** Bypass voltage calibration. Pressing the will increase or decrease the calibration by 0.1% depending on if the up or down arrow is selected. Press “OK” key to confirm the modification.

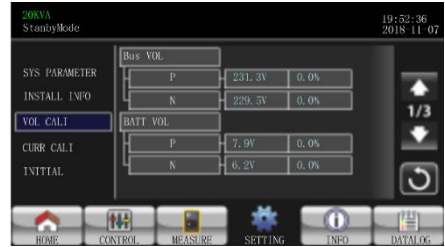

VOL CALI Page 1

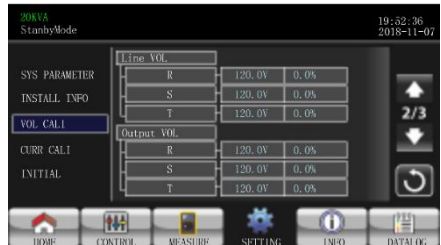

VOL CALI Page 2

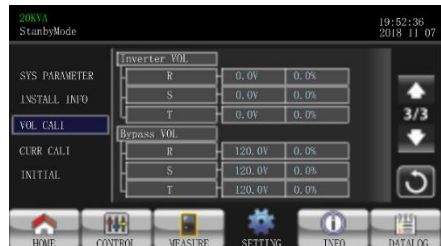

VOL CALI Page 3

## CURR CALI

- Output CURR: Output current calibration. Pressing the will increase or decrease the calibration by 0.1%, depending on if the up or down arrow is selected. Press “OK” key to confirm the modification.

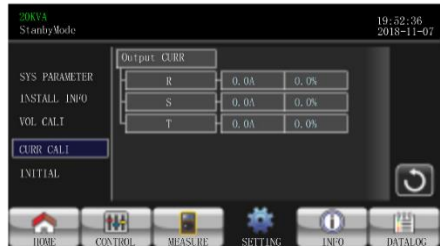

**CURR CALI Page**

## INITIAL

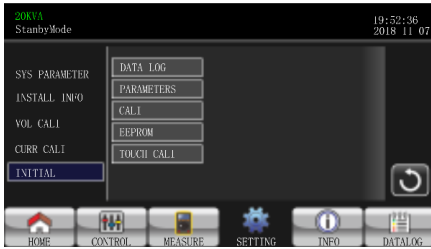

**INITIAL MENU Page**

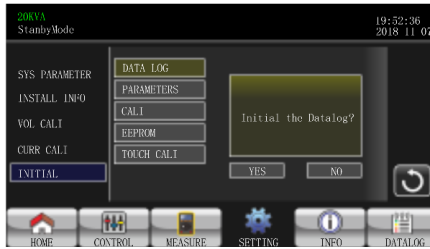

**INITIAL DATALOG Page**

- **DATA LOG:** After pressing, the user will be prompted to “Initial the Datalog?” Touch **Yes** to clear the DATALOG page. Touch **Back** or **No** to cancel this operation and return to INITIAL menu page.
- **PARAMETERS:** After pressing, the user will be prompted to “Initial the Parameters?”. Touch **Yes** to restore default value. Touch **Back** or **No** to cancel this operation and return to INITIAL menu page.



**INITIAL PARAMETERS Page**

- **CALI:** After pressing, the user will be prompted to “Initial the CALI?”. Touch **YES** to restore default calibration value. Touch **Back** or **NO** to cancel this operation and return to INITIAL menu page.

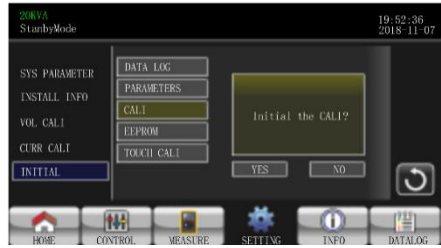
**INITIAL CALI Page**

- **EEPROM:** After pressing, the user will be prompted to “Initial the EEPROM?”. Touch **YES** to clear all setting values in EEPROM. Touch **Back** or **NO** to cancel this operation and return to INITIAL menu page.

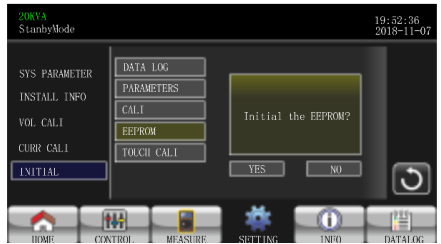
**INITIAL CALI Page**

- **TOUCH CALI:** After pressing, the user will see the blue screen above. Touch screen to recalibrate and click the + in the upper left corner.

**INITIAL TOUCH Page**



## ELECTRICAL

- **Output Voltage:** Select the output rated voltage.

There are two options, 120V and 127V. 120Vac is default setting.

- **Output Rated FRE:** Select output rated frequency.



Electrical Setting Page

**50Hz:** The output frequency is setting for 50Hz.

**60Hz:** The output frequency is setting for 60Hz.

- **CVCF Mode (constant voltage and constant frequency function)**

**Enable:** CVCF function is enabled. The output frequency will be fixed at 50Hz or 60Hz according to setting of “Output Freq.”. The input frequency can range from 40Hz to 70Hz.

**Disable:** CVCF function is disabled. The output frequency will synchronize with the bypass frequency within 45~55 Hz for a 50Hz system or within 55~65 Hz for a 60Hz system. Disable is the default setting.

- **Bypass Forbid:**

**Enable:** Bypass Forbid is enabled. Running in Bypass mode is not allowed under any situations.

**Disable:** Bypass Forbid is disabled. UPS will run in Bypass mode. It is the default setting.

- **Bypass at UPS off:** When manually turning off the UPS, select the bypass status. This setting is only available when “Bypass forbid” is set to “Disable”.



Electrical Setting Page 2

**Enable:** Bypass enabled. Bypass mode is activated.

**Disable:** Bypass disabled. There will be no output through the Bypass when manually turning off the UPS.

- **Bypass Voltage Range:** Set the bypass voltage range.

**L:** Low voltage point for bypass. The setting range is 96V ~ 110V. 96V is default setting.

**H:** High voltage point for bypass. The setting range is 130V ~ 146V. 146V is default setting.

- **Bypass FRE Range:** Set the bypass frequency range.

The acceptable bypass frequency ranges from 46Hz to 54Hz when UPS is 50Hz system and from 56Hz to 64Hz when UPS is 60Hz system.

- **ECO mode:** Enable/Disable ECO mode. Default setting is “Disable”

- **ECO Voltage Range:** Set the ECO voltage range.

**L:** Low voltage point for ECO mode. The setting range is from “Rated output voltage – 5V” to “Rated output voltage - 11V”. “Rated output voltage – 5V” is default setting.

**H:** High voltage point for ECO mode. The setting range is from “Rated output voltage + 5V” to “Rated output voltage + 11V”. “Rated output voltage + 5V” is default setting.

- **ECO FRE Range:** Set the ECO frequency range. The setting range is from 48Hz to 52Hz when the UPS is 50Hz system and from 58Hz to 62Hz when the UPS is 60Hz system.

## BATTERY

### ➤ Battery Warning Voltage:

**HIGH:** High battery warning voltage. The setting range is 14.0V ~ 15.0V. 14.4V is default setting.

**LOW:** Low battery warning voltage. The setting range is 10.1V ~ 14.0V. 11.4V is default setting. This parameter setting is related to “Shutdown Voltage” setting. The setting value should be higher than “Shutdown Voltage” setting.



Battery Setting Page

➤ **Shutdown Voltage:** If battery voltage is lower than this point while in battery mode, the UPS will automatically shut down. The setting range is 10.0V ~ 12.0V. 10.7V is default setting (The setting is only available for long-run model)

### ➤ Battery Parameter:

**Battery AH:** setting battery capacity. 9Ah is default setting.

## MISCELLANEOUS

### ➤ Auto Restart:

**Enable:** Once “Enable” is set, and the UPS shutdown occurs due to low battery and the utility restores, the UPS will return to line mode.

**Disable:** Once “Disable” is set, and the UPS shutdown occurs and the utility restores, the UPS will shut down per delay minutes set.



Miscellaneous Setting Page

- **Shutdown Delay Min:** UPS will shut down per delay minute set. The countdown will start after confirming the pop-up screen.
- **Restore Delay Min:** UPS will automatically restart per restore delay minutes set after the UPS shuts down.
- **New Password:** Set up User new password to enter “ADVANCED User” menu page.
- **Default User Password:**
  - YES:** User password will restore default setting value.
  - NO:** The UPS will cancel this operation.

## UPS SELF-TEST

This function is only effective when UPS type setting is “HV”. Therefore, please disconnect all loads and utility first before executing this function. Then, please change UPS type to “HV”. For the detailed operation, please check “System Parameter” menu under Advanced Maintainer directory.

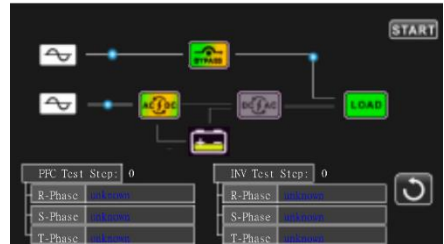

After changing UPS type to “HV”, you must restart the UPS. After the UPS is restarted, please enter Advance screen and enter Maintainer password. It will show “UPS SELFTEST” selection in the screen. In the screen, all tested items are shown “unknown”. Simply click “UPS SELFTEST” button, the UPS will start self-test. If the UPS is normal, it will show “Normal” in all columns. Otherwise, “Unknown” will be displayed in the columns.

### 3.3.5 Information screen

Touch  to enter information page. Touch  or  to browse information. Touch  to return to main screen. Touch  to go back to previous menu.

## Basic Information

- **MCU Version:** MCU version.
- **DSP Version:** DSP version.
- **Serial NO.:** The serial number of UPS.
- **Manufacturer:** The information about manufacturer.
- **Service Contact:** The contact name is set in “Basic Setting”.
- **Service Phone:** The listed numbers are set in “Basic Setting”.
- **Service Mail:** The service email account is set in “Basic Setting”.



Basic Information Page

- **SYS Install Date:** The date of system installation.
- **BAT Install Date:** The date of battery installation.
- **PAR State:** The information of parallel state.
- **PAR ID:** The UPS ID number in parallel state.
- **Input Source:** The information of input source.
- **All Mute:** Enable/disable all mute function.
- **Mode Mute:** Enable/disable mode mute function.



Basic Information Page 2

## Rated Information

- **Output Voltage:** Output rated voltage.
- **Output FRE:** Output rated frequency.
- **CVCF Mode:** Enable/Disable CVCF mode.
- **Bypass Forbid:** Enable/disable bypass function.



Rated Information Page

- **Bypass UPS Off:** Enable/disable auto bypass function when UPS is off.
- **Auto Restart:** Enable/disable auto-restart function.
- **ECO Mode:** Enable/disable ECO function.

## Parameter Information

- **Line Voltage Range:** The acceptable line input voltage range.
- **Line FRE Range:** The acceptable line input frequency range.
- **Bypass Voltage Range:** The acceptable input voltage range for bypass mode.
- **Bypass FRE Range:** The acceptable input frequency range for bypass mode.
- **ECO Voltage Range:** The acceptable input voltage range for ECO mode.
- **ECO FRE Range:** The acceptable input frequency range for ECO mode.



Parameter Information Page

- **BATT Mode Work Time:** The maximum discharge time in battery mode.
- **BATT Warning Voltage:**

**HIGH:** High battery warning voltage.

**LOW:** Low battery warning voltage.

- **Shutdown Voltage:** If battery voltage is lower this point, UPS will Automatically shut down.



Parameter Information Page 2

- **Battery Age:** It shows battery age.
- **Battery AH:** It shows battery AH.
- **Battery Number:** It shows battery number.
- **Charger Number:** The information of charger number.

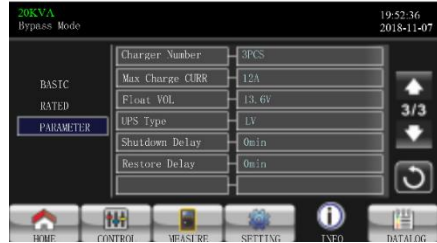

Parameter Information Page 3

- **Max Charge CURR:** The setting value of the maximum charging current.
- **Float VOL:** The setting value of the battery float voltage.
- **UPS Type:** The information of UPS type.
- **Shutdown Delay:** UPS will shut down in setting minutes. The countdown will start after confirming the pop-up screen.
- **Restore Delay:** UPS will automatically restart in setting minutes after the UPS shuts down.

### 3.3.6 Data Log screen

Touch to enter date log page. Data log is used to record the warning and fault information of the UPS. The record contains date & time, code, type and description. Touch or to page up or down if there are more than one page in the date log. Touch to return to main screen. Press to go back to main menu. Please refer to Section 3-7 and 3-8 for warning and fault code list.

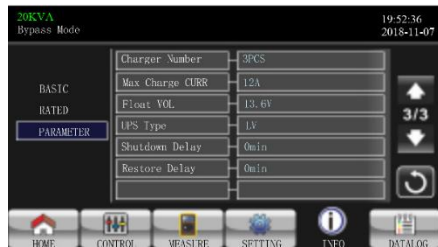

Data Log Page

### 3.4 Audible Alarm

Description	Buzzer status	Muted
<b>UPS status</b>		
Bypass mode	Beeping once every 2 minutes	Yes
Battery mode	Beeping once every 4 seconds	
Fault mode	Beeping continuously	
<b>Warning</b>		
Overload	Beeping twice every second	No
Others	Beeping once every second	
<b>Fault</b>		
All	Beeping continuously	Yes

### 3.5 Single UPS Operation

#### 1. Turn ON the UPS with utility power (in AC mode)

- a.) After the power mains is connected correctly, set the battery pack breaker to ON position (this step only necessary for long-run model). Then set the line input breaker to ON position. At the same time the fan will start running and the UPS will start initialization. In just a few seconds, the UPS will supply power to the loads via the Bypass mode.

---

**NOTE:**

When UPS is in Bypass mode, the output voltage will be directed from mains after you switch on the input breaker. In Bypass mode, the load is not protected by the UPS. To protect your precious devices, you should turn on the UPS. Refer to next step.

- 
- b.) Touch CONTROL and select UPS on/off icon. User will be prompted to "Turn on UPS?". Select YES. Refer to On/Off UPS screen.



- c.) In just a few seconds, the UPS will enter into AC mode. If the mains is abnormal, the UPS will operate in Battery mode without interruption.
- 

**NOTE:**

When the UPS runs out of battery power, it will shut down automatically in Battery mode. When the mains is normalized, the UPS will auto restart in AC mode.

---

**2. Turn on the UPS without utility power supply (in Battery mode)**

- d.) Make sure that the two strings of batteries are connected correctly in order of "+, GND, -" terminals and the battery pack breaker is in the ON position (only for long-run model).
- e.) Press the  **POWER** button to set up the power supply for the UPS. UPS will enter power on mode. After initialization, the UPS will enter to "No Output mode".
- f.) In just a few seconds, the UPS will be turned on and enter Battery mode.

**3. Connect devices to UPS**

After the UPS is turned on, you can connect devices to the UPS.

- a.) Turn on the UPS first and then switch on the devices one by one. The LCD panel will display total load level.
- b.) If it is necessary to connect the inductive loads such as a printer, the in-rush current of the load should be calculated carefully to see if it meets the overload capability of the UPS. Any load more than 150% over designed capacity the runtime will be less than 60ms
- c.) If the UPS is on overload, the buzzer will beep twice every second.

- d.) When the UPS is on overload, please remove some loads immediately. It is recommended to have the total loads connected to the UPS less than 80% of its nominal power capacity to prevent overload for system safety.
- e.) If the overload time is over acceptable time listed in spec in AC mode, the UPS will automatically transfer to Bypass mode. After the overloading is resolved, it will return to AC mode. If the overload time is over the acceptable time listed in the spec in Battery mode, the UPS will enter “fault status”. At this time, if bypass is enabled, the UPS will power to the load via bypass. If bypass function is disabled or the input power is not within the acceptable bypass range, it will cut off output entirely.

#### **4. Charge the batteries**

- a.) After the UPS is connected to the mains and turned on in AC mode, the charger will charge the batteries automatically; except in battery mode, during battery self-test, overload or when battery voltage is high.
- b.) It is recommended to charge batteries for at least 10 hours before operation. Otherwise, the backup time may be shorter than expected.

#### **5. Battery mode operation**

- a.) When the UPS is in Battery mode, the buzzer will sound according to different battery capacity. If the battery capacity is more than 25%, the buzzer will beep once every 4 seconds. If the battery voltage drops to the alarm level, the buzzer will beep once every second to remind users that the battery is at a low level and the UPS will eventually shut down. Switching off some non-critical loads to disable the shutdown alarm may prolong the backup time. If there is no more load to be switched off, users must prepare shutdown procedure to preserve working

data or devices. Otherwise, there is a risk of data loss or load failure.

- b.) In Battery mode, users can touch “SETTING” → “Basic” → Audio Mute to enable “Mode Mute” to disable the buzzer.
- c.) The backup time of the long-run model depends on the external battery capacity.
- d.) The backup time may vary from different operating temperature and load type.
- e.) After discharging the default backup time of 16.5 hours, the UPS will shut down automatically to protect the battery. This battery discharge protection can be enabled or disabled through LCD menu.

## **6. Test the Batteries**

- a.) If you need to check the battery status when the UPS is running in AC mode/CVCF mode, touch “CONTROL” and select “Battery Test”. Refer to “Battery Test” screen.
- b.) Users also can set battery self-test through monitoring software.

## **7. Turn OFF the UPS with utility power supply in AC mode**

- a.) Touch CONTROL and select the Turn off UPS icon to turn off the UPS. Refer to “UPS on/off” screen.

**NOTE 1:** If the UPS has been set to bypass output, it will bypass voltage from the mains to output terminal even though the user has turned off the UPS (inverter).

**NOTE 2:** After turning off the UPS, please be aware that the UPS is working in Bypass mode and there will be risk of power loss for connected devices.

---

- b.) In Bypass mode, output voltage of the UPS is still present. In order to cut off the output, switch off the line input breaker. The LCD display will turn off and UPS is now completely off.

## **8. Turn off the UPS without utility power supply in Battery mode**

- a.) Touch CONTROL and select Turn off UPS icon to turn off the UPS. Refer to “UPS on/off” screen.
- b.) Then UPS will cut off power to output terminals.

## **9. Mute the buzzer**

- a.) Touch SETTING and then select BASIC item. There are two events available to mute. Refer to SETTING screen.
- b.) Some warning alarms cannot be muted unless the error is fixed. Please refer to section 3-4 for details.

## **10. Operation in warning status**

- a.) When LCD screen shows “Fault Mode” and the buzzer beeps once every second, it indicates that there are operational problems. Users can read the warning message(s) from “DATA LOG” menu. Please refer to the Section 3-3-6 for details.
- b.) Some warning alarms cannot be muted unless the error is fixed. Please refer to Section 3-4 for details.

## **11. Operation in Fault mode**

- a.) When the buzzer beeps continuously, it means that there is a fatal error with the UPS. Users can get the fault code from “DATA LOG” menu. Please refer to the Section 3-3-6 for details
- b.) Please check the loads, wiring, ventilation, mains, battery and so on after the fault occurs. Do not try to turn on the UPS again before solving the issues. If the problems persist, contact the distributor or service personnel immediately.
- c.) In case of an emergency, shut off connections from the mains, external battery, and output immediately to avoid possible damage to the UPS or equipment.

## **12. Operation in maintenance mode**

This operation should only be performed by maintenance personnel or qualified technicians.

When the UPS needs repair or service and the load cannot be shut off, the UPS needs to be put into maintenance mode.

- a.) First, switch off the UPS.
- b.) Then, remove the cover of maintenance bypass switch on the panel.
- c.) Turn the maintenance switch to “BPS” position.

## **3.6 Parallel Operation**

### **1. Parallel system initial startup**

Please make sure that all the running UPSs are parallel models and have the same configuration.

- a.) Turn ON each UPS in AC mode respectively (Refer to section

3-5 (1)). Then, measure the inverter output voltage of each phase for each UPS with a multi-meter. Calibrate the inverter output voltage by configuring inverter voltage adjustment (Refer to SETTING -> VOL CALI screen) in LCD menu until the inverter output voltage difference of each UPS is within 1V or less.

- b.) Turn OFF each UPS (Refer to section 3-5 (7.)). Then, follow the wiring procedure in section 2-5.
- c.) Remove the cover of parallel share current cable port on the UPS, connect each UPS one by one with the parallel cable and share current cable, and then replace the cover.
- d.) Turn ON the parallel system in AC mode:
  - Turn on the line input breaker of each UPS. If using dual-input unit, please also turn on the external bypass input breaker. After all UPSs enter bypass mode, measure the output voltage between two UPSs for the same phase to make sure the phase sequence is correct. If these two voltage differences are near to zero, that means all connections are met. Otherwise, please check if the wirings are connected correctly.
  - Turn ON the output breaker of each UPS.
  - Turn ON each UPS in turns. After a while, the UPSs should enter into AC mode synchronously and then, the parallel system is now complete.
- e.) Turn ON the parallel system in Battery mode:
- f.) Turn ON the battery breaker (only available in long-run model) and external output breaker of each UPS.
  - Turn ON any UPS. A few seconds later, the UPS will enter battery mode.

- Turn ON the next UPS in sequence until all the UPSs enter Battery mode and are added to the parallel system. Now the parallel system is now complete.

For more information regarding the parallel operation, please contact SurgeX Technical Support for detailed instruction.

## **2. Add new units into the parallel system**

- a.) You cannot add new units into the parallel system when the whole system is running. You must cut off the load and shut down the system.
- b.) Make sure all UPSs are the parallel models and follow the wiring reference in section 2-5.
- c.) Install the new parallel system as per section 2-6. d.)

Remove units from the parallel system. There are two methods to remove units from the parallel system:

### **First Method:**

- a.) Touch “CONTROL” è “Turn off UPS” and select “Yes” to turn off the UPS. Then, the UPS will enter Bypass mode or No Output mode without output.
- b.) Turn off the external output breaker on this unit, and then turn off the input breaker of this unit.
- c.) Turn off the battery breaker (only available in long-run model) and remove the parallel and share current cables. And then remove the unit from the parallel system.

### **Second Method:**

- a.) If the bypass is abnormal, you cannot remove the UPS without interruption. You must cut off the load and shut down the system.

- b.) Make sure the bypass setting is enabled in each UPS and then turn off the system. All UPSs will transfer to Bypass mode. Remove all the maintenance bypass covers and set the maintenance switches from “UPS” to “BPS” position. Turn off all the input breakers and battery breakers in parallel system.
- c.) Turn OFF the output breaker and remove the parallel cable and share current cable of the UPS which you want to remove. Now, you can remove the UPS from parallel system.
- d.) Turn ON the input breaker of the remaining UPS and the system will transfer to Bypass mode. Set the maintenance switches from “BPS” to “UPS” position and put the maintenance bypass covers back on.
- e.) Turn ON the remaining UPS according to the previous section.

**WARNING (Only for Parallel System)**

---

- Before turning on the parallel system to activate inverter, make sure that all units’ maintenance switches are in the same position.
  - When parallel system is turned on, please do not operate the maintenance switch of any unit.
  - The parallel system DOES NOT support ECO mode. Therefore, please DO NOT “enable” ECO mode in any unit.
-



## 3.7 Fault Code

Fault Code	Fault Event	Icon	Fault Code	Fault Event	Icon
01	Bus start failure	None	42	DSP communication failure	None
02	Bus over	None	43	Overload	None
03	Bus under	None	46	Incorrect UPS setting	None
04	Bus unbalance	None	47	MCU communication failure	None
06	Converter over current	None	48	Two DSP firmware versions are incompatible in parallel system.	None
11	Inverter soft start failure	None	49	Input and output phase are incompatible	None
12	High inverter voltage	None	60	Bypass phase short circuited	None
14	Inverter R output (line to neutral) short circuited		61	Bypass SCR short circuited	
15	Inverter S output (line to neutral) short circuited	None	62	Bypass SCR open circuited	None
16	Inverter T output (line to neutral) short circuited	None	63	Voltage waveform abnormal in R phase	None
17	Inverter R-S output (line to line) short circuited	None	64	Voltage waveform abnormal in S phase	None
18	Inverter S-T output (line to line) short circuited	None	65	Voltage waveform abnormal in T phase	None
19	Inverter T-R output (line to line) short circuited	None	66	Inverter current sample abnormal	None
1A	Inverter R negative power fault	None	67	Bypass O/P short circuited	None
1B	Inverter S negative power fault	None	68	Bypass O/P line to line short circuited	None
1C	Inverter T negative power fault	None	69	Inverter SCR short circuited	None
21	Battery SCR short circuited	None	6C	BUS voltage drops too fast	None
23	Inverter relay open circuited	None	6D	Current sampling error value	None
24	Inverter relay short circuited	None	6E	SPS power error	None
25	Line wiring fault	None	6F	Battery polarity reverse	None
31	Parallel communication failure	None	71	PFC IGBT over-current in R phase	None

Fault Code	Fault Event	Icon	Fault Code	Fault Event	Icon
32	The host signal failure	None	72	PFC IGBT over-current in S phase	None
33	Synchronous signal failure	None	73	PFC IGBT over-current in T phase	None
34	Synchronous trigger signal failure	None	74	INV IGBT over-current in R phase	None
35	Parallel communication loss	None	75	INV IGBT over-current in S phase	None
36	Parallel output current unbalance	None	76	INV IGBT over-current in T phase	None
41	Over temperature	None	77	LCD & MCU communication failure	None

### 3.8 Warning Code

Warning Code	Warning Event	Warning Code	Warning Event
01	Battery unconnected	21	Line situations are different in parallel system
02	IP Neutral loss	22	Bypass situations are different in parallel system
04	IP phase abnormal	33	Locked in bypass after overload 3 times in 30 minutes
05	Bypass phase abnormal	34	Converter current unbalanced
07	Over charge	3A	Cover of maintain switch is open
08	Low battery	3C	Utility extremely unbalanced
09	Overload	3D	Bypass is unstable
0A	Fan failure	3E	Battery voltage too high
0B	EPO enable	3F	Battery voltage unbalanced
0D	Over temperature	40	Charger short circuited

## 4.0 TROUBLESHOOTING

If the UPS system does not operate correctly, please solve the problem by using the table below.

Symptom	Possible Cause	Remedy
No indication and alarm in the front display panel even though the mains is normal.	The AC input power is not connected well.	Check if input cable firmly connected to the mains.
The warning code 0B.	EPO function is activated. The EPO switch is in "OFF" status or the jumper is open.	Set the circuit in closed position to disable the EPO function.
The warning code 01.	The external or internal battery is incorrectly connected.	Check if all batteries are connected well.
The warning code 09.	UPS is overloaded.	Remove excess loads from UPS output.
	UPS is overloaded. Devices connected to the UPS are fed directly by the electrical network via the Bypass.	Remove excess loads from UPS output.
	After repetitive overloads, the UPS is locked in the Bypass mode. Connected devices are fed directly from the mains.	Remove excess loads from UPS output first. Then shut down the UPS and restart it.
Fault code is shown as 43.	UPS is overloaded too long and becomes fault. Then UPS shuts down automatically.	Remove excess loads from UPS output and restart it.
Fault code is shown as 14, 15, 16, 17, 18 or 19,	The UPS shuts down automatically because a short circuit occurs on the UPS output.	Check output wiring and if connected devices are in short circuit status.
Other fault codes are shown on the LCD display and the alarm beeps continuously.	A UPS internal fault has occurred.	Contact SurgeX

Symptom	Possible Cause	Remedy
Battery backup time is shorter than nominal value.	Batteries are not fully charged.	Charge the batteries for at least 7 hours and then check capacity. If the problem still persists, consult SurgeX.
	Batteries defect	Contact SurgeX to replace the battery.
The warning code 0A.	Fan is locked or not working. Or the UPS temperature is too high.	Check fans and notify dealer.
The warning code 02.	The input neutral wire is disconnected.	Check and correct the input neutral connection. If the connection is ok and the warning is still displaying, please check input fuses of S and T.
	The S or T input fuse is broken.	Replace the fuse.

## 5.0 STORAGE AND MAINTENANCE

### 5.1 Storage

Before storing, charge the UPS at least 7 hours. Store the charged UPS covered and upright in a cool, dry location. During storage, recharge the battery in accordance with the following table:

Storage Temperature	Recharge Frequency	Charging Duration
-25°C - 40°C	Every 3 months	1-2 hours
40°C - 45°C	Every 2 months	1-2 hours

### 5.2 Maintenance

---

 **CAUTION**

The UPS system utilizes hazardous voltages. Repairs may be carried out only by factory authorized service personnel.

---

 **WARNING**

Even after the unit is disconnected from the mains, components inside the UPS system are still connected to the battery packs which are potentially dangerous.

---

 **CAUTION**

Before carrying out any kind of service and/or maintenance, disconnect the batteries and verify that no current is present, and no hazardous voltage exists in the terminals of high capability capacitor such as BUS-capacitors.

---

 **CAUTION**

Only factory authorized personnel may replace batteries and/or perform service operations. Unauthorized persons must be kept well away from the batteries.

---

 **WARNING**

Verify that no voltage is present between the battery terminals and the ground before maintenance or repair. In this product, the battery circuit is not isolated from the input voltage. Hazardous voltages may occur between the battery terminals and the grounding/earthing.

---

---

 **CAUTION**

---

Batteries may cause electric shock and have a high short-circuit current. The following precautions should be observed when working on batteries:

- a) Remove watches, rings, or other metal objects.
- b) Use tools with insulated handles.
- c) Wear rubber gloves and boots.
- d) Do not lay tools or metal parts on top of batteries.
- e) Disconnect charging source prior to connecting or disconnecting battery terminals.
- f) Remove battery grounds during installation and maintenance to reduce likelihood of shock. Remove the connection from ground if any part of the battery is determined to be grounded.

---

 **CAUTION**

---

Batteries must only be replaced by the same number and battery type.

---

 **CAUTION**

---

Do not attempt to dispose of batteries by burning them. This could cause battery explosion. The batteries must be disposed in compliance with all local environmental regulations.

---

 **CAUTION**

---

Do not open or destroy batteries. Escaping electrolyte can cause injury to the skin and eyes. It may be toxic.

---

 **CAUTION**

---

Please replace the fuses only with the same type and amperage in order to avoid fire hazards.

---

 **CAUTION**

---

Do not disassemble the UPS system.

---

## 6.0 SPECIFICATIONS

CAPACITY*		20KVA / 20KW	30KVA/ 30KW	40KVA/ 40KW
<b>INPUT</b>				
Nominal Voltage		3 x 208/220 VAC (Ph-Ph) 3 x 120/127 VAC (Ph-N)		
Voltage Range	Low Line Loss	138 VAC (Ph- Ph) ± 3 % at 50% Load		
		172 VAC (Ph- Ph) ± 3 % at 100% Load		
	Low Line Comeback	Low Line Loss Voltage + 5V		
	High Line Loss	270 VAC (Ph- Ph) ± 3 % at 50% Load		
		253 VAC (Ph- Ph) ± 3 % at 100% Load		
High Line Comeback	High Line Loss Voltage - 5V			
Frequency Range		46Hz ~ 54 Hz @ 50Hz system		
		56Hz ~ 64 Hz @ 60Hz system		
Phase		3 Phase with Neutral		
Power Factor		≥ 0.99 at 100% Load		
<b>OUTPUT</b>				
Phase		3 Phase with Neutral		
Output Voltage		3 x 208/220 VAC (Ph-Ph) 3 x 120/127 VAC (Ph-N)		
AC Voltage Regulation		± 1%		
Frequency Range (Synchronized Range)		46Hz ~ 54 Hz @ 50Hz system		
		56Hz ~ 64 Hz @ 60Hz system		
Frequency Range (Batt. Mode)		50 Hz ± 0.1 Hz or 60Hz ± 0.1 Hz		
Overload	AC Mode	>300%: 140 ms >130%: 1s 110%~130%: 1m 100%~110%: 1h		
	Battery Mode	100%~110%: 30sec; 110%~130%: 10sec; >130% : 1sec		
Current Crest Ratio		3:1 max		
Harmonic Distortion		≤ 2 % @ 100% Linear Load; ≤ 4 % @ 100% Non-linear Load (PF≥0.8)		
Transfer Time	Line Battery	0 ms		
	Inverter Bypass	0 ms (When phase lock fails, <4ms interruption occurs from inverter to bypass)		
<b>EFFICIENCY</b>				
AC Mode		94%		
Battery Mode		92.50%		
ECO Mode		97%		

BATTERY						
Standard Model	Type	12 V / 9 Ah	12 V / 9 Ah	12 V / 9 Ah	N/A	
	Numbers	(10+10) pcs x 1 string	(10+10) pcs x 2 strings	(10+10) pcs x 3 strings		
	Recharge Time	9 hours recover to 90% capacity				
	Charging Current (max.)	1A/2A/3A/4A (Adjustable)				
	Charging Voltage	+/-136.5 VDC ± 1%				
Long-run Model	Type	Depending on applications				
	Numbers	8 ~ 10 (adjustable)				
	Charging Current (max.)	4A/8A/12A (Adjustable)	4A/8A/12A (Adjustable) Optional parallel up to Max. 20A		4A/8A/12A/16A (Adjustable) Optional parallel up to Max. 24A	
	Charging Voltage	+/- 13.65 VDC * N ± 1% (N = 8~10)				
PHYSICAL						
Standard Model	Dimension, D x W x H (mm)	667 x 250 x 827	865 x 300 x 1020		N/A	
	Net Weight (kgs)	95	181	231		
Long-run Model	Dimension, D x W x H (mm)	667 x 250 x 827	865 x 300 x 1020		790 x 420 x 1200	
	Net Weight (kgs)	45	80	81	150	160
ENVIRONMENT						
Operation Temperature		0 ~ 40°C (the battery life will down when > 25°C)				
Operation Humidity		<95 % and non-condensing				
Operation Altitude**		<1000m**				
Acoustic Noise Level		Less than 60dB @ 1 Meter	Less than 70dB @ 1 Meter	Less than 70dB @ 1 Meter	Less than 70dB @ 1 Meter	Less than 75dB @ 1 Meter
MANAGEMENT						
Smart RS-232 or USB		Supports Windows® 2000/2003/XP/Vista/2008/7/8/10, Linux, Unix, and MAC				
Optional SNMP		Power management from SNMP manager and web browser				

\* If the UPS is installed or used in a place where the altitude is above than 1000m, the output power must be de-rated 1% per 100m.

\*\* Product specifications are subject to change without further notice.



## Facility Data Planning Guide Three-Phase UPS

20-40kVA UPS (208V input, 208V output)			
Power Rating (kVA/ kW)	20/20	30/30	40/40
Voltage	208 VAC	208 VAC	208 VAC
kW (Nom./Max)	20/20	30/30	40/40
Current (Nom./ Max)	56/67	83/100	111/134
Min. Input AWG (includes Neutral)	6	3	1/0
External Overcur- rent Protection	70A	110A	150A
Nominal Voltage	240V DC	240V DC	240V DC
Maximum Dis- charge	83A/string	125A/ string	167A/ string
Current Nominal	56	83	111
Minimum Output AWG	6	3	2
External Overcur- rent Protection	70	100	125
Dimensions W x D x H	12" x 34" x 40	17" x 31" x 47"	17" x 31" x 47"
Weight lbs.	508	330	362
Floor Loading lbs./ sq.in.	1.24	.70	.70
Height Rejection kBTU/Hr.	5.14	7.70	10.27
Cooling Air CFM	612	1224	1224

## Notes:

1. Nominal (Nom.) current based on rated load
2. Maximum (Max.) current based on 173V (@100% load) input voltage
3. Input and output cables typically run in separate conduits.
4. If initial load is less than UPS rated output, it is recommended that AC input, battery, and AC output wiring and overcurrent protection be sized to UPS full load rating to accommodate possible to future expansion.
5. Nominal battery voltage - (lead technology) (2.0 volts/ cell, cutoff 1.7 volts/cell)
6. If user provided DC cables should be sized for not more than a 2.0% line drop at maximum
7. Suggested AC output overcurrent protection based on continuous full load current per NEC 210-20.
8. All wiring to be in accordance with the applicable national and/or local electrical codes. (Conductor sizes based on insulation rated at 90° C)
9. Minimum access clearance per UPS Owner's Manual
10. Control wiring and power wiring to be run in separate conduit.
11. Nominal output current based on matching AC input / output voltages
12. 240V DC with Neutral (10+10)

### Additional Notes:

- A. Ratings of cables and overcurrent devices supplied for information only. User to consult with it's own engineering services before adopting.
- B. Reference NEC handbook. Consult local codes for possible variations.

### UPS Connections:

- 10 kVA - Terminals with M5 bolt

\* Calculation based on ambient operating temperature of 25° C

**Life Critical Applications**

While SurgeX believes it designs and manufactures very reliable Products, many of the vendors that SurgeX sources components from do not recommend or endorse the use of their Products in life critical applications. By extension, SurgeX must adhere to the same business policy and does not recommend the use of our Products in life critical applications.

**Disclaimer**

SurgeX Products are not designed, intended, authorized, tested, or UL Listed for use in systems intended to support or sustain life, or for any other application in which the failure of a SurgeX Product could create a situation where personal injury or death may occur. Should Buyer purchase or use SurgeX Products for any such unintended or unauthorized application, Buyer shall indemnify and hold SurgeX and its officers, employees, subsidiaries, affiliates and distributors harmless against all claims, costs, damages and expenses, and reasonable attorney fees arising out of, directly or indirectly, any claim or personal injury or death associated with such unintended or unauthorized use, even if such claim alleges that SurgeX was negligent regarding the design or manufacture of the part.

