









ASSEMBLY INSTRUCTIONS









PROD.NO : BTG/BTH/BTP1002Q

Thank you for purchasing this quality product . Please read instructions thoroughly before unpacking assembly parts
 Caution: Sharp, exposed staple tips can cause injury. Therefore, for your protection, please remove any exposed staples used in packing.

Please keep all hardware parts out of the reach of children.

1. We recommend that you should assemble this product with the assistance of another person; this will make assembly easier and will help to prevent personal injury and to insure parts are not damaged during assembly process.
2. Before beginning, please check packing materials carefully for small parts that may have come loose inside the carton during shipping. Do not discard any packing material until all parts have been located. If any parts are missing, please contact your dealer for prompt replacement.
3. To prevent damage to your floor or carpet, please check the bottom of each piece of furniture for stain residues and rough surfaces and also check for staples or nails left after removing the packing materials .The manufacturer will not be held responsible if preventive steps are not taken prior to installation.
4. Please do not over tighten screws or bolts. During normal use everyday, screws, bolts , nuts and wooden plugs may loosen up. They should be periodically inspected and re-tightened to prevent damage to the furniture and (or) personal property or cause injury. Always check to be sure all hardware on this list and below mentioned components are attached to the furniture property and kept tightened.
5. Please lay all parts and hardware on a non-abrasive surface such as a carpet and follow the assembly.

Components List :			
NO.	DESCRIPTION		Q' TY
A		HB Right Leg	1pc
B		HB Left Leg	1pc
C		Headboard	1pc
D		Wood stretcher	1pc
E		Footboard	1pc
F		Side rail	2pcs
G		Slat	4pcs
H		Support Leg	4pcs

Hardware List				
NO.	DESCRIPTION	SIZE	SKETCH	Q' TY
1	Flat Washers	8*19*2mm		8pcs
2	Spring Washers	8mm		16pcs
3	Allen Bolts	1/4"*1-9/16"		2pcs
4	Allen Bolts	5/16"*1-9/16"		6pcs
5	Allen Key	4*30*80mm		1pc
6	Allen bolt	5/16" * 3"		8pcs
7	Half moon washer	Ø5/16"		8pcs
8	Hex nut	Ø5/16"*12mm		8pcs
9	Wrench	12mm		1pc
10	Wood Screw	#8*1-1/4"		8pcs

TIP: Store the Allen key and Wrench in assembly in this product drawer or use masking or painter tape to affix it to the underside of the product. This will make it easier to find if you want to periodically tighten bolts or disassemble the product.

STEP 1: Attach the Wood Stretcher (D) to both Headboard Legs (A&B) using provided hardware as shown on FIG.1

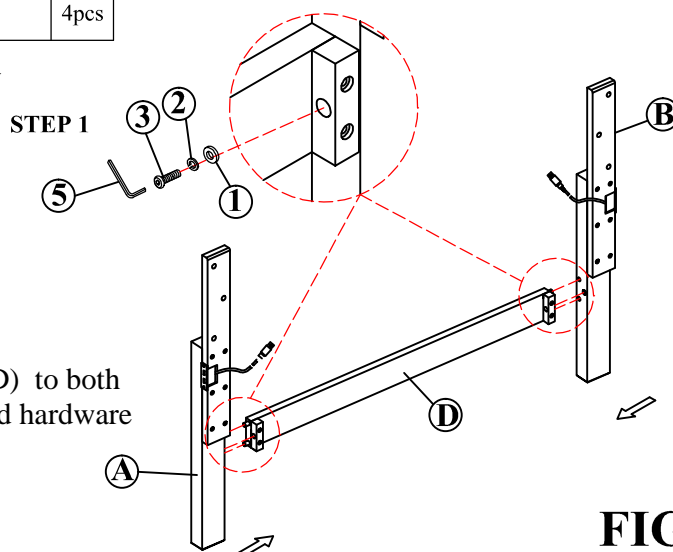
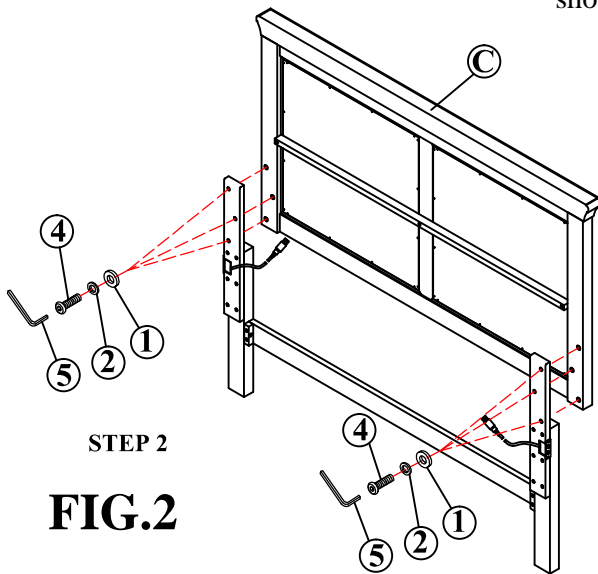

FIG.1

ASSEMBLY INSTRUCTIONS

PROD.NO : BTB/BTG/BTH/BTP1002Q

STEP 2: Attach the Headboard (C) to the Legs assembly (A,B&D) using provided hardware as shown on FIG.2



STEP 2

FIG.2

STEP 3: Attach both Bed Rails (F) to the Footboard (E) using the provided hardware as shown on FIG.3

STEP 4: Attach both Bed Rails (F) to the Headboard assembly (A,B,D&C) using the provided hardware as shown on FIG.4

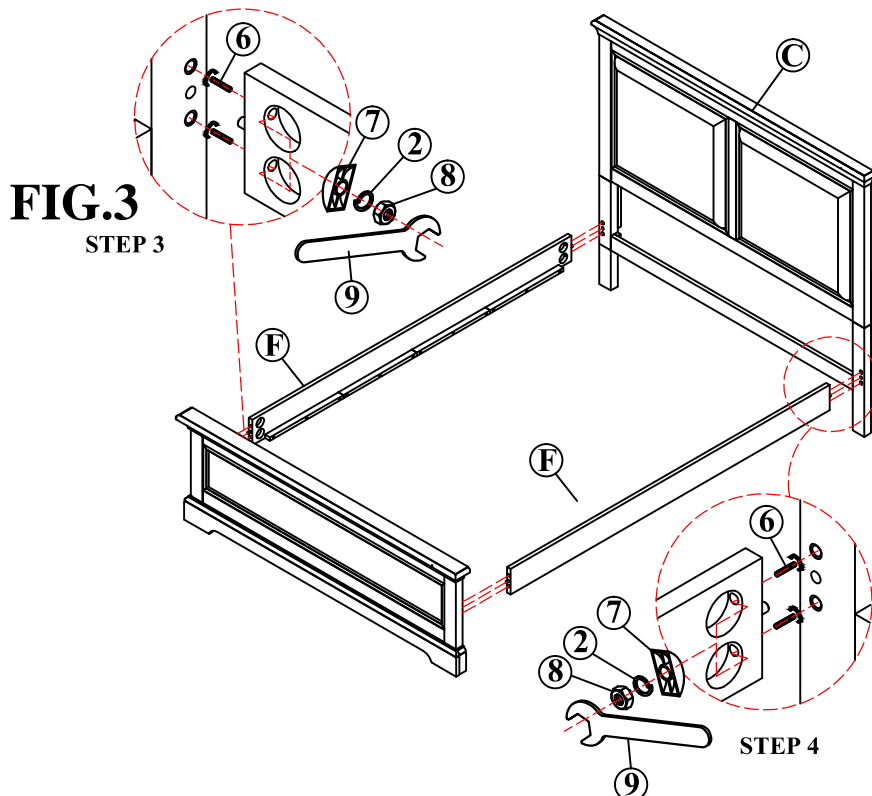

FIG.3

STEP 3

FIG.4

STEP 4

WINNERS ONLY®

ASSEMBLY INSTRUCTIONS

PROD.NO : BTB/BTG/BTH/BTP1002Q

FIG.5

STEP 5

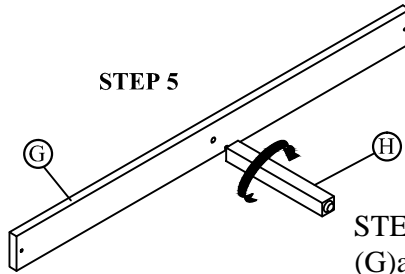

STEP 5: Attach Support Legs (H) to Slats (G) as shown on FIG.5

STEP 6

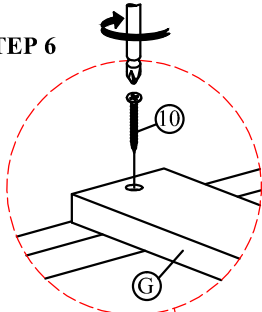

STEP 6: Attach Slats with Support legs (G&H) to the Side Rail (F) using the provided hardware as shown on FIG.6

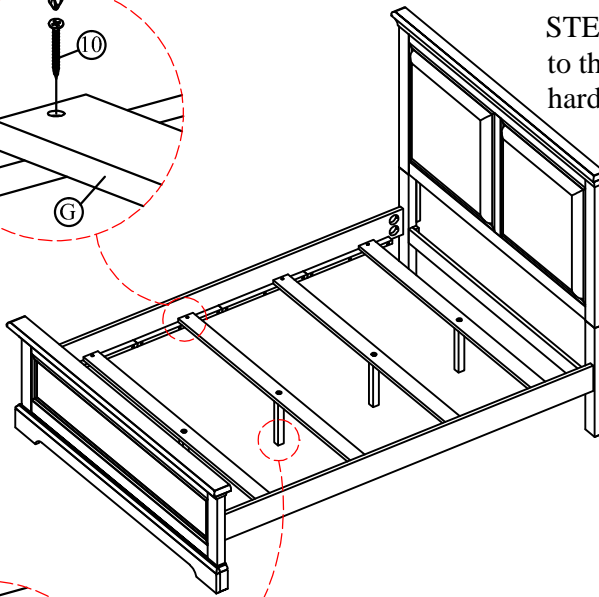

Assembly is now completed.

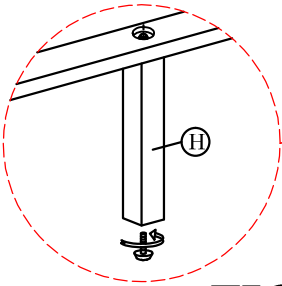

FIG.6

