

homestyles

6801-402

Sectional

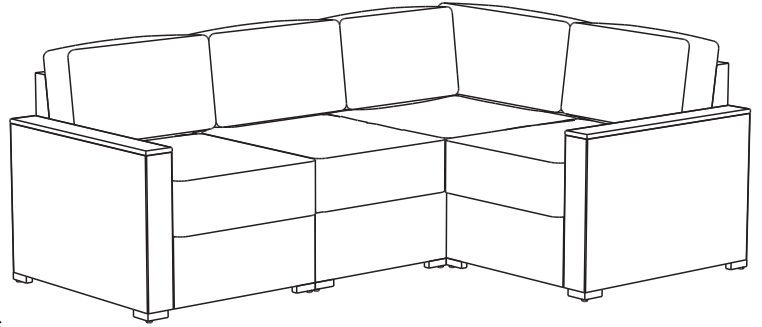

IMPORTANT

Carefully remove all the parts from the carton and place them individually on a soft cloth to prevent scratches or other damage.

Carefully and strictly follow these assembly instructions to ensure a completed product as designed.

Do not use power tools above 8 volts to assemble.

Part List

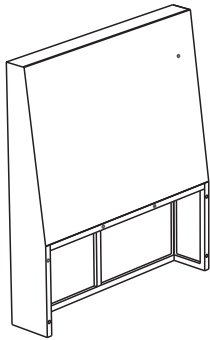

L.
Back
1 pc.

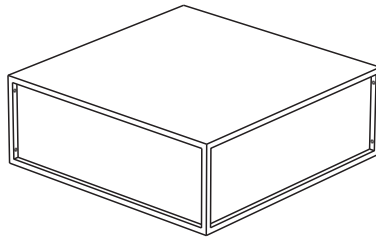

M.
Seat
1 pc.

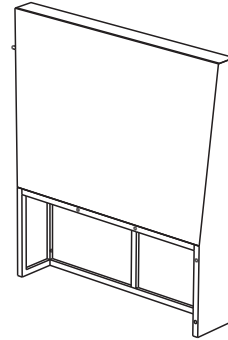

N.
Back
1 pc.

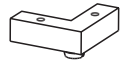

E.
Foot
4 pcs.

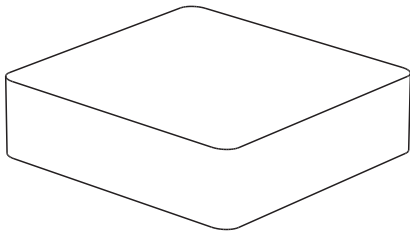

H.
Seat Cushion
1 pc.

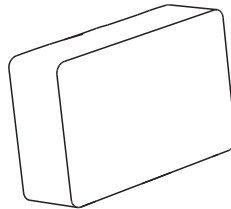

I.
Back Cushion
1 pc.

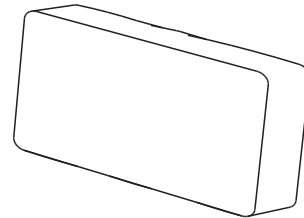

K.
Back Cushion
1 pc.



J.
Clip
6 pcs.

Hardware List

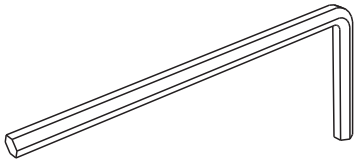

Hex Wrench
1 pc.



Small
Hex Wrench
1 pc.

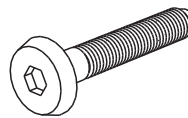

M6x35
Head Cap Bolt
18 pcs. (+1 extra)



Spring Washer
18 pcs. (+1 extra)



Flat Washer
18 pcs. (+1 extra)

Cartons 6801-401 and 6801-CUS3 are also needed for assembly.

homestyles Customer Service: www.homestylesfurniture.com,
servicedesk@homestylesfurniture.com, 888-680-7460

Assembly Instructions 2/7

IMPORTANT

- Use a soft cloth between these parts and the floor.
- Do not use power tools above 8 volts to assemble.
- Do not tighten all the bolts until each part is properly assembled.
- The unit must be level to work properly. Use the included adjustable levelers to level.
- Keep Hex Wrench as the bolts may need to be tightened in the future.

Follow instructions in 6801-401 carton first, then proceed with Step 13.

Corner Unit

STEP 13

Attach Seat (M) to Back (N) with Head Cap Bolts, Spring Washers and Flat Washers, tightening bolts only halfway.

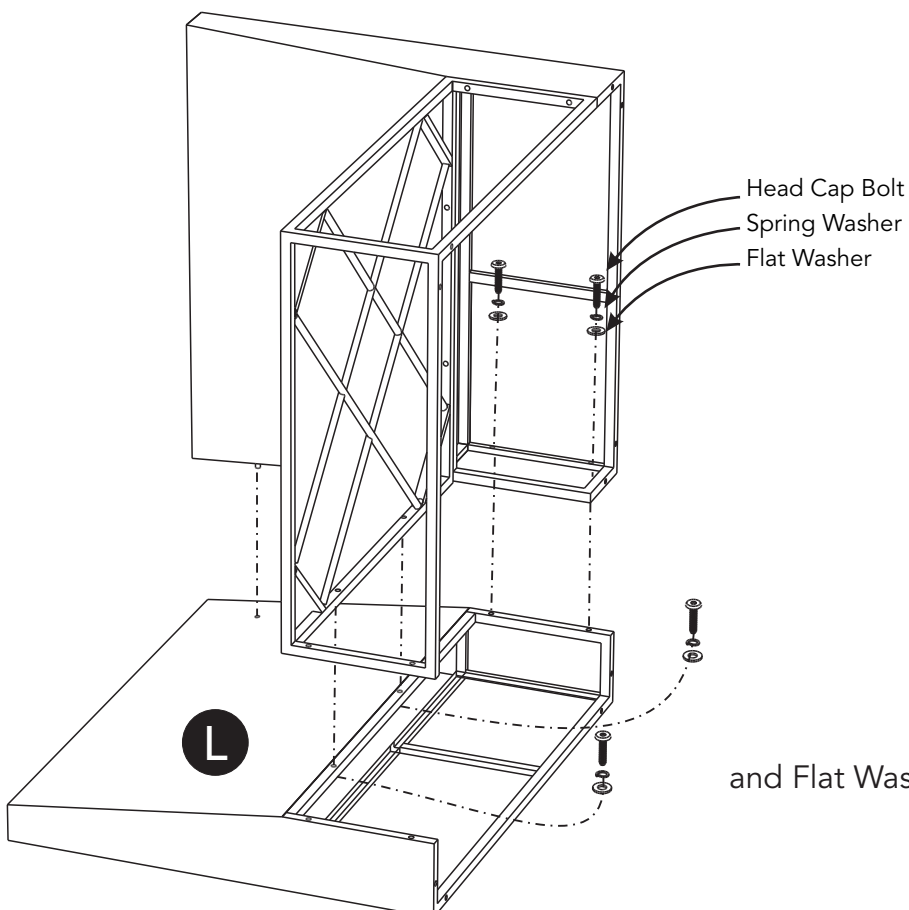
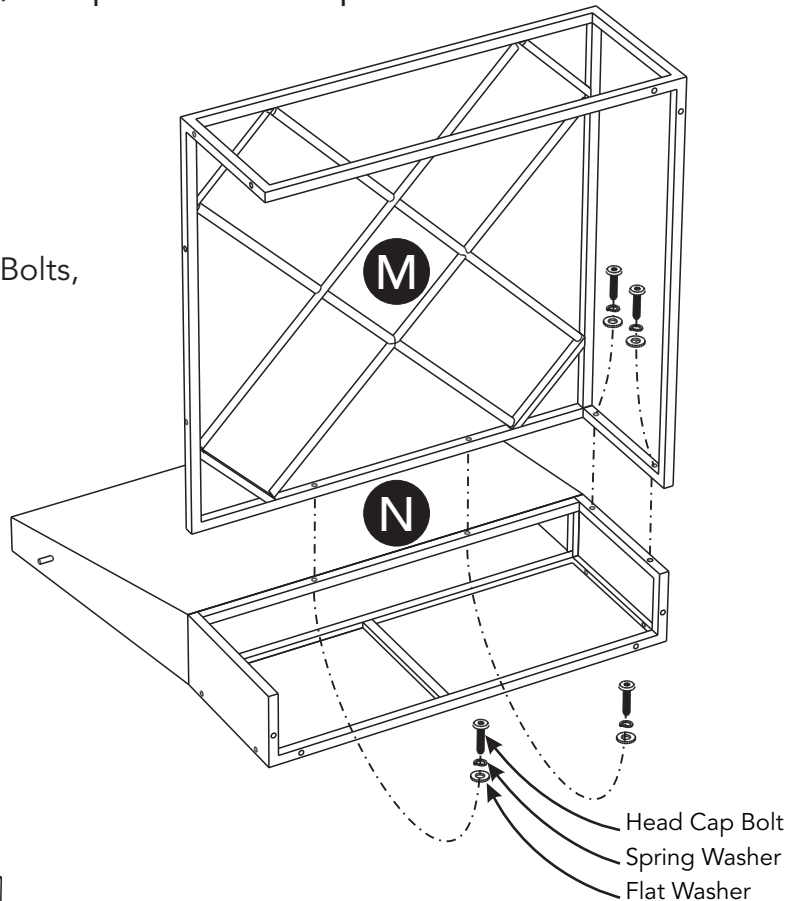

STEP 14

Attach Back (L) to unit with Head Cap Bolts, Spring Washers and Flat Washers, tightening bolts only halfway.

Assembly Instructions 3/7

STEP 15

Insert Head Cap Bolts, Spring Washers and Flat Washers into unit, tightening bolts only halfway.

Tighten all bolts used in Steps 13, 14 and 15.

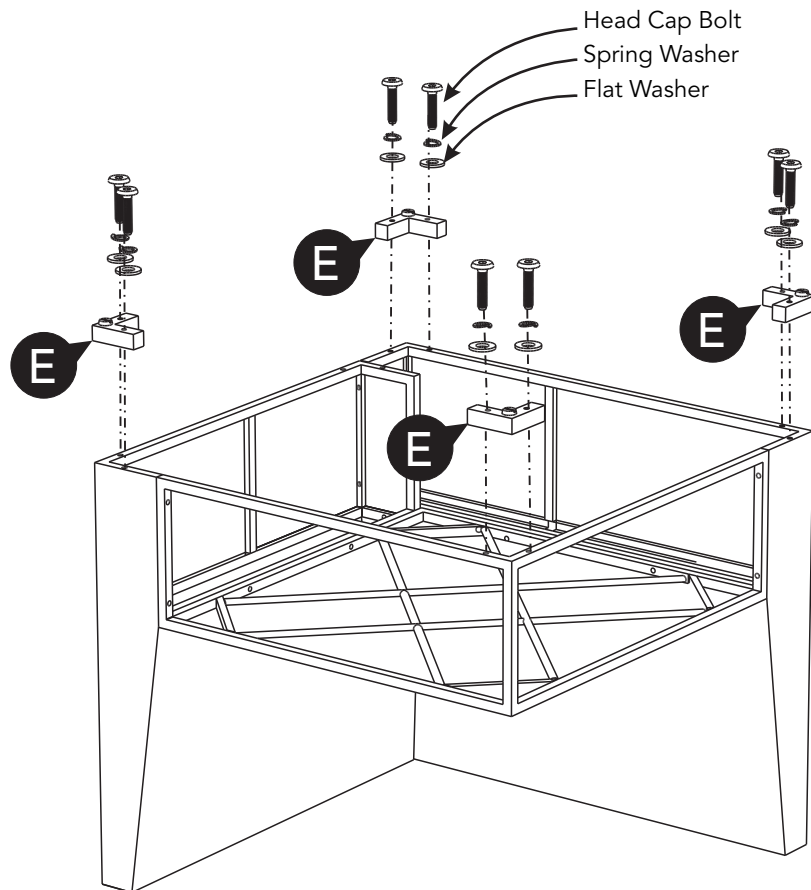
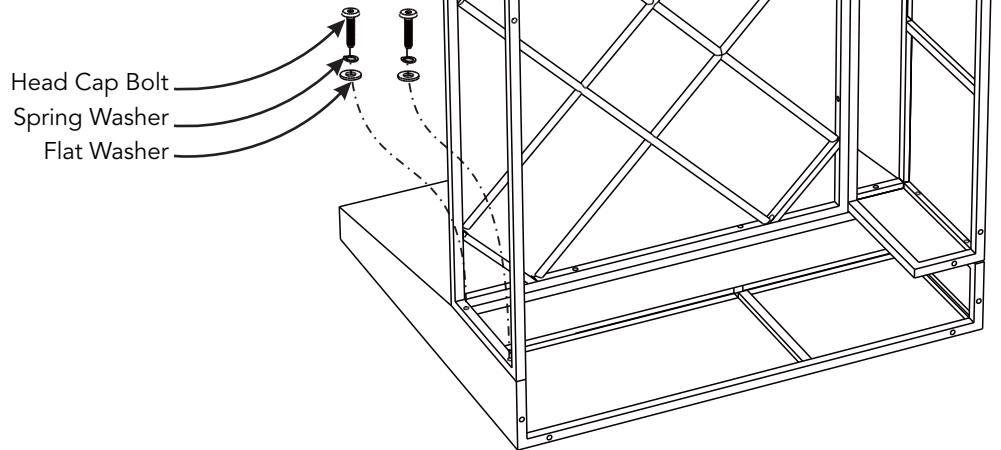

STEP 16

Attach Feet (E) to unit with Head Cap Bolts, Spring Washers and Flat Washers.

For a 4 seat sectional, complete Steps 17 and 18.

For a 5 seat sectional, follow instructions in 6801-58 carton, then complete Steps 19 and 20.

For a 6 seat sectional, follow instructions in 2 6801-58 cartons, then complete Steps 21 and 22.

For a 7 seat sectional, follow instructions in 3 6801-58 cartons, then complete Steps 23 and 24.

4 Seat Sectional

STEP 17

Attach left unit, middle unit, corner unit and right unit with Clips (J).
(See Figure 4)

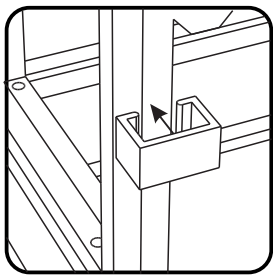

Figure 4

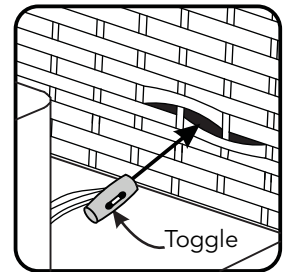
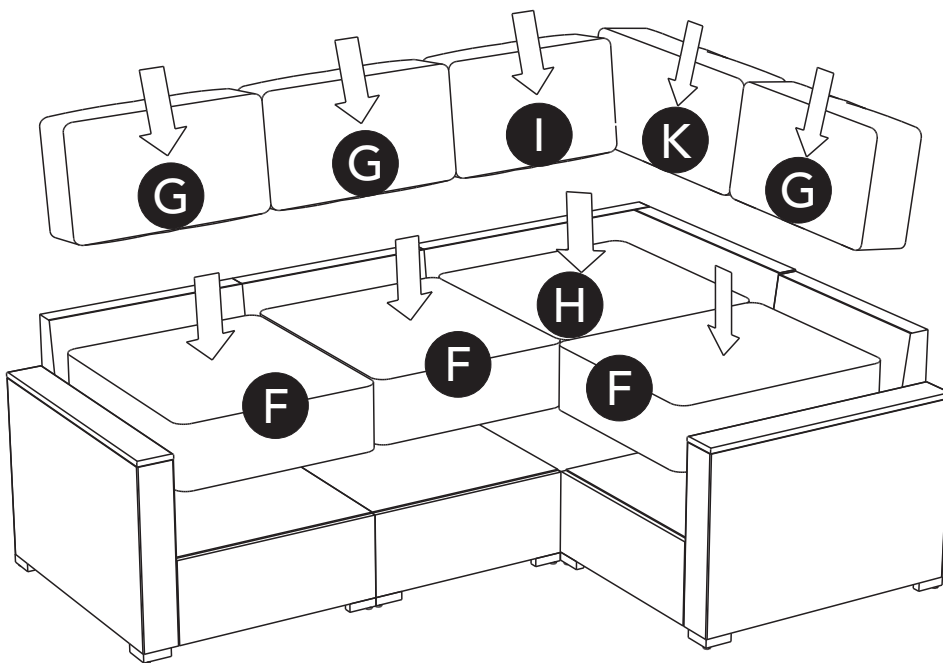
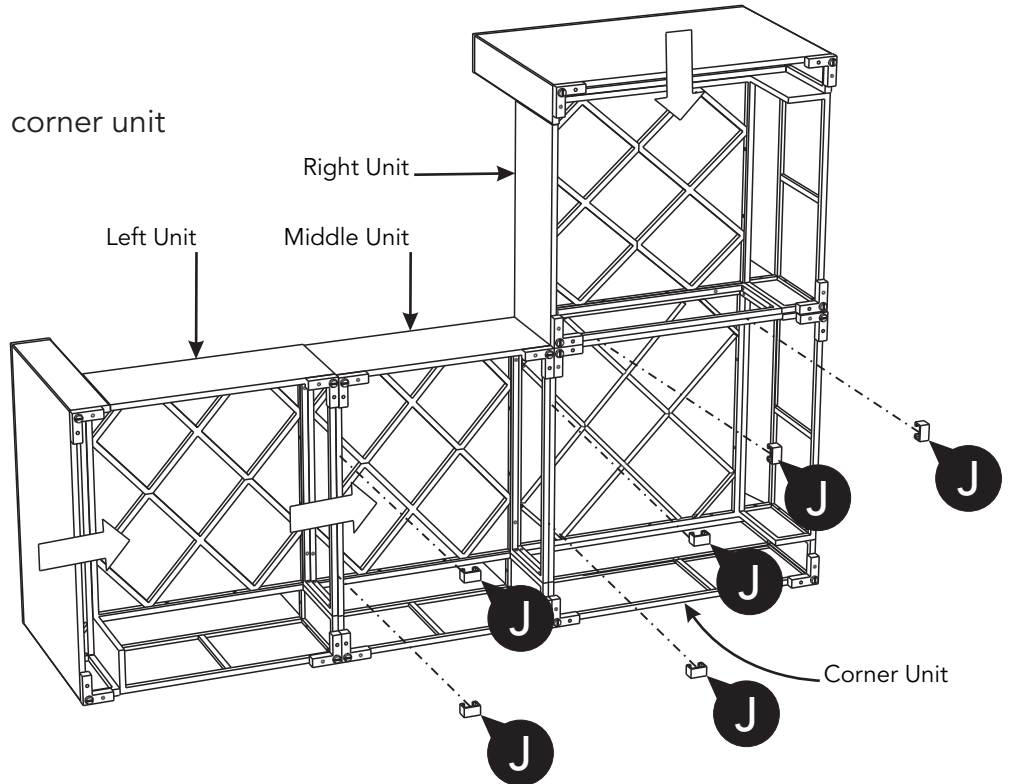

Figure 5

STEP 18

Turn unit to its upright position.

Attach Seat Cushions (F) to unit by pushing toggles through weaving in back of unit.
(See Figure 5)

Place Seat Cushion (H) and Back Cushions (I), (K) into position.

Level unit by adjusting the adjustable levelers on bottom of unit.
(See Figure 6)

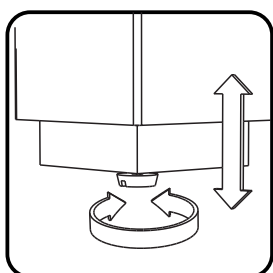

Figure 6

5 Seat Sectional

STEP 19

Attach left unit, middle units, corner unit and right unit with Clips (J).
(See Figure 7)

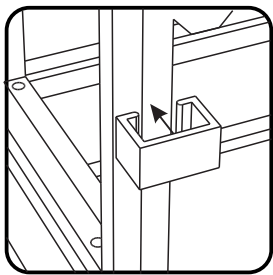

Figure 7

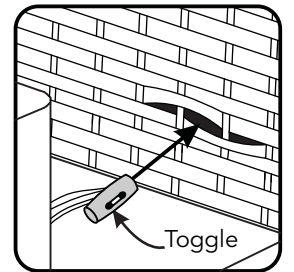
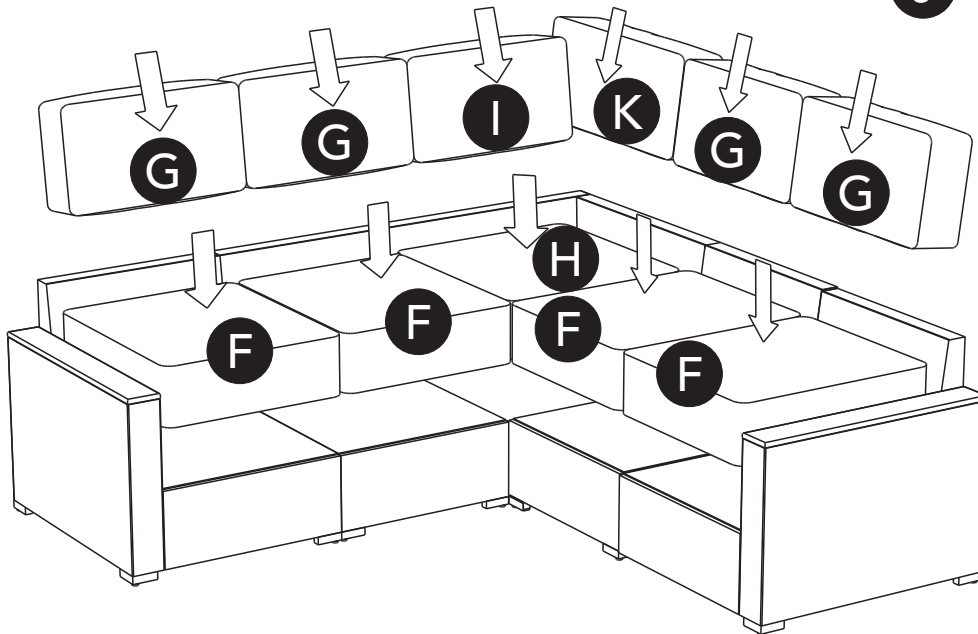
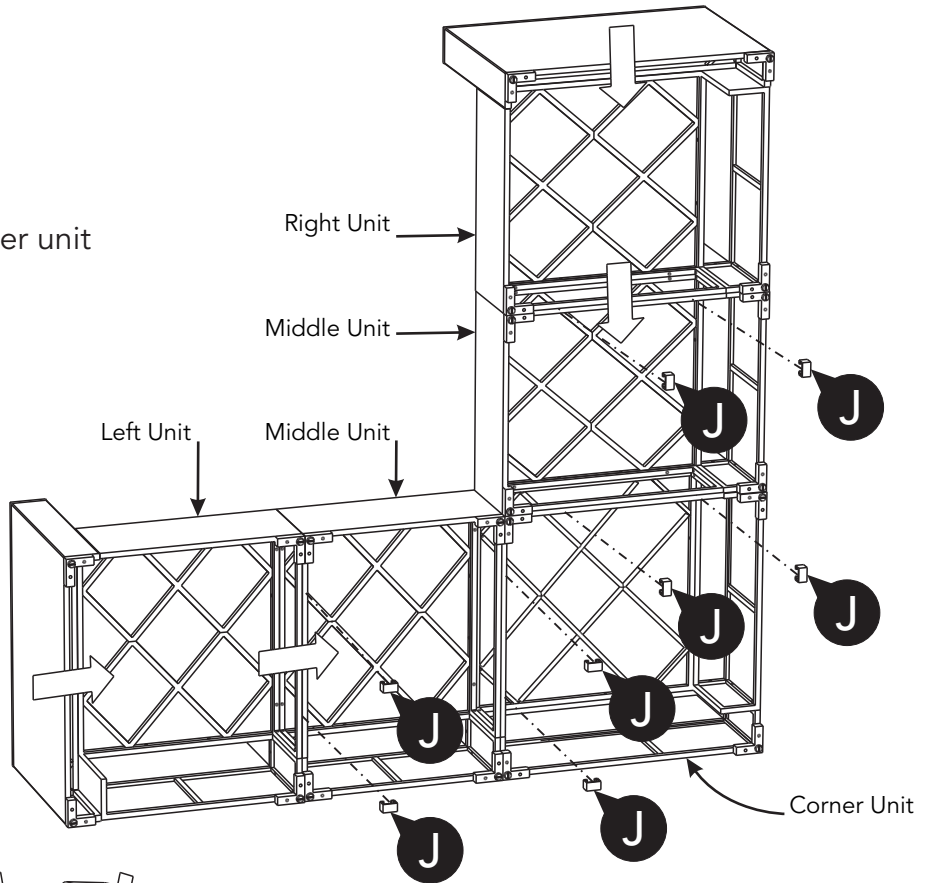

Figure 8

STEP 20

6801-CUS carton is also needed for this step.

Turn unit to its upright position.

Attach Seat Cushions (F) to unit by pushing toggles through weaving in back of unit.
(See Figure 8)

Place Seat Cushion (H) and Back Cushions (I), (K) into position.

Level unit by adjusting the adjustable levelers on bottom of unit.
(See Figure 9)

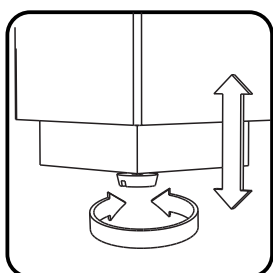

Figure 9

6 Seat Sectional

STEP 21

Attach left unit, middle units, corner unit and right unit with Clips (J).
(See Figure 10)

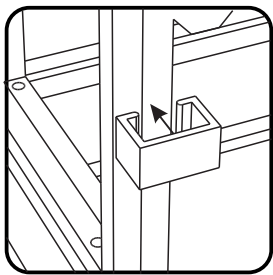

Figure 10

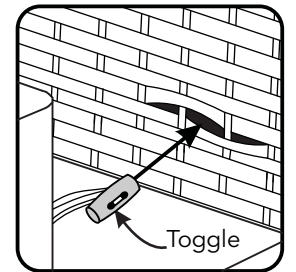
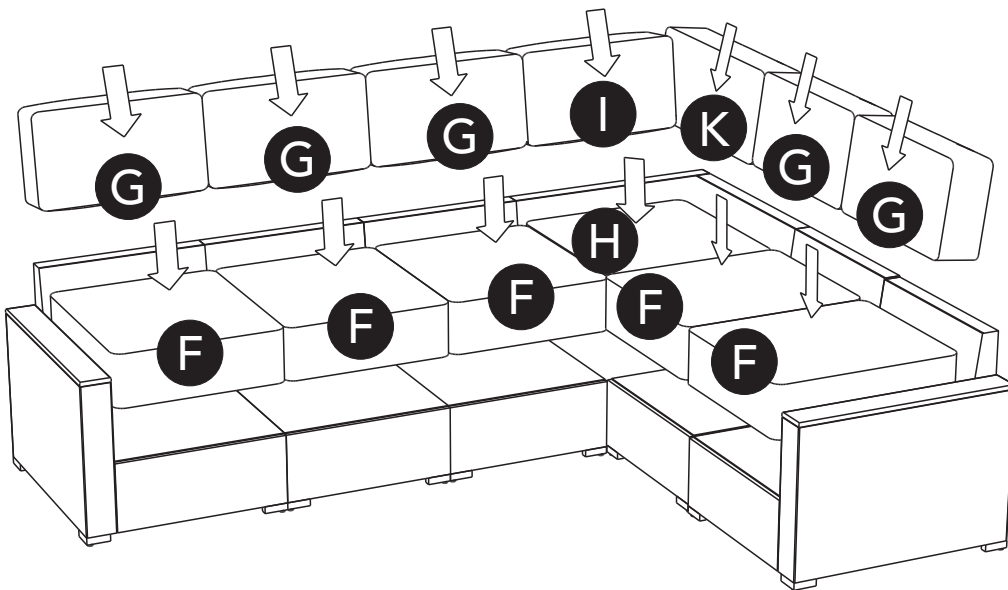
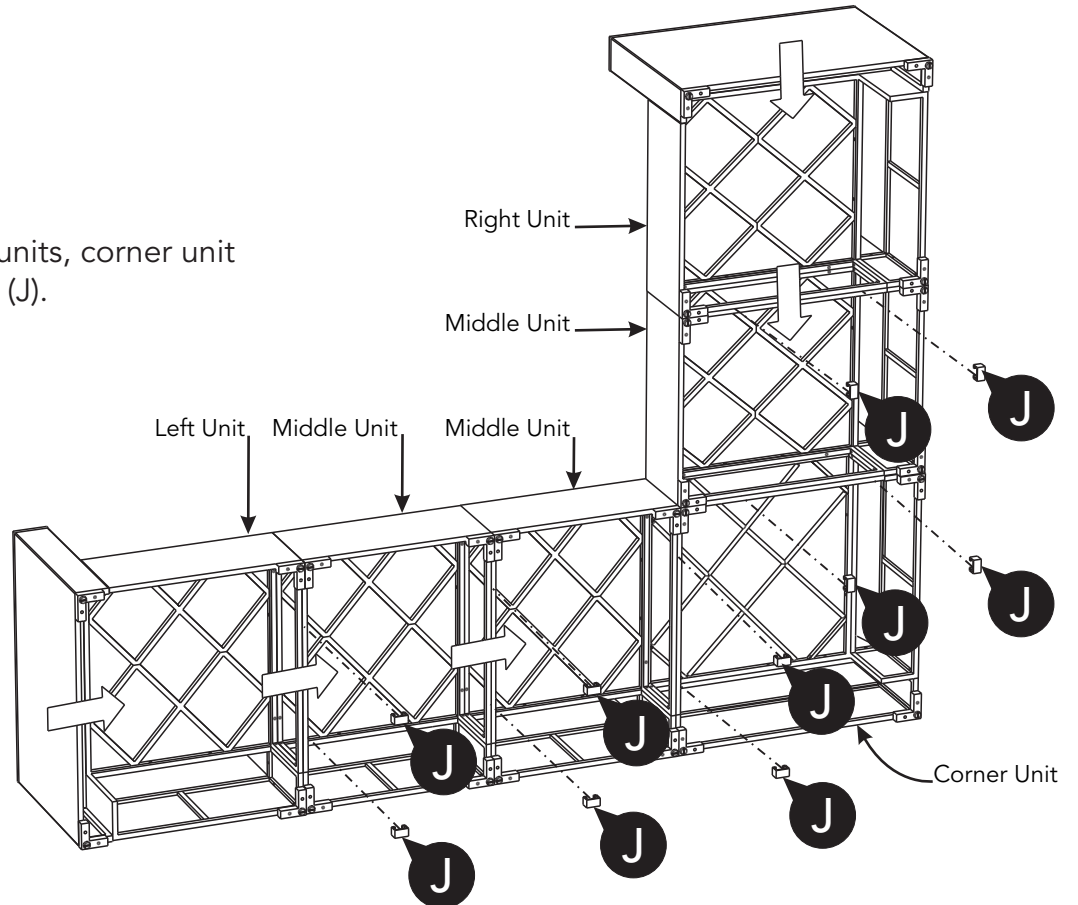

Figure 11

STEP 22

Two 6801-CUS cartons are also needed for this step.

Turn unit to its upright position.

Attach Seat Cushions (F) to unit by pushing toggles through weaving in back of unit.
(See Figure 11)

Place Seat Cushion (H) and Back Cushions (I), (K) into position.

Level unit by adjusting the adjustable levelers on bottom of unit.
(See Figure 12)

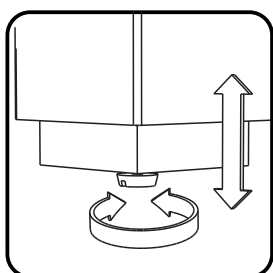

Figure 12

7 Seat Sectional

STEP 23

Attach left unit, middle units, corner unit and right unit with Clips (J).
(See Figure 13)

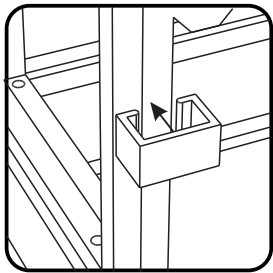

Figure 13

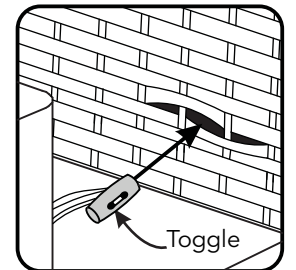
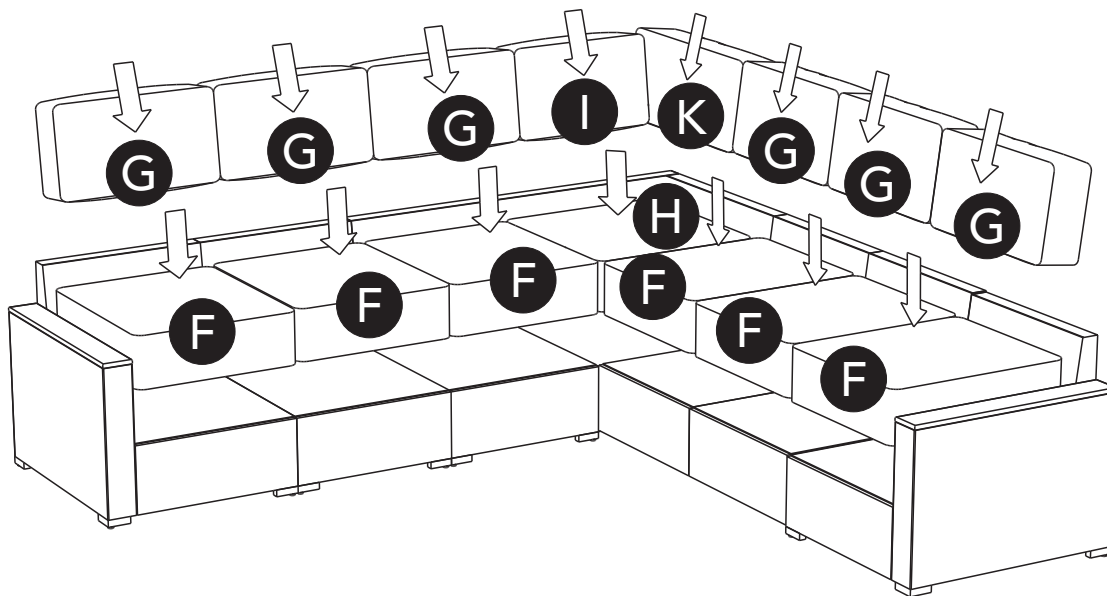
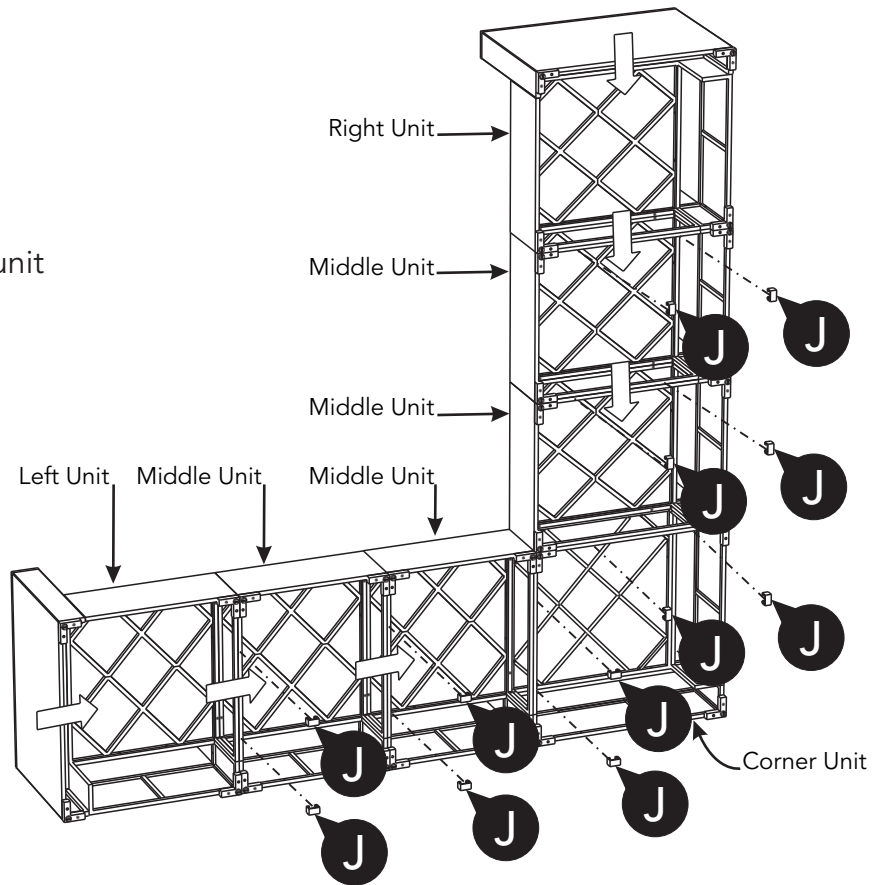

Figure 14

STEP 24

Three 6801-CUS cartons are also needed for this step.

Turn unit to its upright position.

Attach Seat Cushions (F) to unit by pushing toggles through weaving in back of unit.
(See Figure 14)

Place Seat Cushion (H) and Back Cushions (I), (K) into position.

Level unit by adjusting the adjustable levelers on bottom of unit.
(See Figure 15)

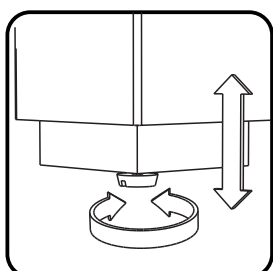

Figure 15

CARE INSTRUCTIONS

NEVER

allow liquids to remain on furniture.
Absorption causes parts to warp
and split and finishes to delaminate.

NEVER

use glass cleaners on
finished furniture. Ammonia
chemically attacks the finish.



Do not use power tools
above 8 volts to assemble.

**PREVENT
CRACKING**

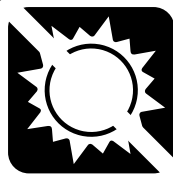

Do not place
in direct sunlight.

**PREVENT
FADING**



Do not write
directly on surface.

**PREVENT
MARKING**



Do not place hot
objects on surface.

**PREVENT
FINISH DAMAGE**

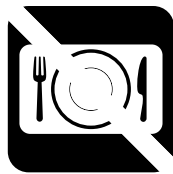

Do not use rubber
based placemats.

**PREVENT
DISCOLORING**



Do not use commercial
waxes and polishes.

**PREVENT
YELLOWING**

CLEAN

with a soft cloth moistened
in lukewarm soap and water.
Buff with a dry clean cloth.



homestyles will provide replacements free of charge for missing or damaged parts within 1 year of purchase. Digital images of the defective parts may be required. If the product was not purchased from an authorized retailer, **homestyles** is under no obligation to provide replacement parts. Parts are not available for fully assembled items nor are parts available for sale. Replacements for missing or damaged parts may be requested via contact info below.

homestyles Customer Service: www.homestylesfurniture.com,
servicedesk@homestylesfurniture.com, 888-680-7460