

KM 3485 G

Gas cooktop

with 2 dual wok burners for particularly versatile cooking convenience.



- Simple controls -single-handed operation via rotary dial control
- Professional design – 42 1/2 (1079) in (mm) wide stainless steel trough
- Particularly versatile – 6 burners incl. Two dual woks
- Extremely safe – GasStop function
- Easy cleaning – ComfortClean dishwasher-safe grates

EAN: 4002514141190 / Material number: 06792850 / Old Material Number: 26348550USA

Heating type	
Fuel type	Gas
Construction type	
Independent of oven	•
Design	
Cast iron pot rests (matte black enameled)	•
Ring features	
No. of rings	6
1st cooking zone/cooking area	
Position	front left
Type	Dual wok burner
Max. rating in W	4500
2nd cooking zone/cooking area	
Position	rear left
Type	Standard burner
Max. rating in W	2600
3rd cooking zone/cooking area	
Position	rear center
Type	High-speed burner
Max. rating in W	3500
4th cooking zone/cooking area	
Position	rear right
Type	Standard burner
Max. rating in W	2600
5th cooking zone/cooking area	
Position	front right
Type	Dual wok burner
Max. rating in W	4800
6th cooking zone/cooking area	
Position	front center
Type	High-speed burner
Max. rating in W	3500
Control panel	
Operation via knobs	•
Electronic ignition with one-handed operation	•
QuickStart	•
Safety	
GasStop & ReStart	•
Technical data	
Dimensions (width) in in. (mm)	42 1/2 (1079)
Dimensions (height) in in. (mm)	5 (125)
Depth in in. (mm)	21 3/8 (542)
Cutout dimensions in mm (width) with surface-mounted installation	42 1/2 (1079)
Cutout dimensions in mm (depth) with surface-mounted installation	20 1/2 (518)
Weight in lbs. (kg)	63 (29)
Total connected load in kW	21.50
Power cord length in in. (m)	3 (1.2)
Voltage in V	120

KM 3485 G

Gas cooktop

with 2 dual wok burners for particularly versatile cooking convenience.



EAN: 4002514141190 / Material number: 06792850 / Old Material Number: 26348550USA

Frequency in Hz

60

Accessories supplied

Number of mains cables with plug

No

KM 3485 G

Gas cooktop

with 2 dual wok burners for particularly versatile cooking convenience.

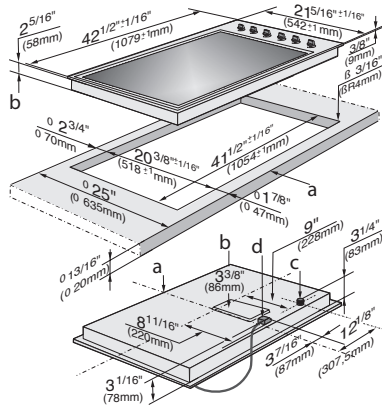

KM 3484/KM3485 (Installation drawing) – USA

1. Front, 2. Installation height, 3. Gas connection, 4. Electrical connection