



OWNER'S MANUAL

30" and 36" Electronic Induction Cooktop

Pour obtenir une version française de ce manuel d'instructions,
visitez notre site monogram.com.

Para consultar una versión en español de este manual de instrucciones,
visite nuestro sitio de internet monogram.com.

TABLE OF CONTENTS

MODEL INFORMATION	2
CONSUMER SUPPORT	3
SAFETY INFORMATION	4
USING YOUR COOKTOP	6
Features	6
Operating The Cooking Elements	7
Turn Burner(s) Off	7
Selecting Cooktop Settings	8
How To Synchronize Left Elements	8
Power Sharing	9
Cooktop Lockout	9
Single Kitchen Timer	9
Cooktop Communication Module Setup	10
Wi-Fi Commissioning	10
Bluetooth® Pairing	11
Precision Cooking	11
Hot Light Indicator	14
Pan Detection Removal	14
Custom Settings	15
How Induction Cooking Works	16
Cooking Noise	16
Choosing The Correct Cookware To Use	17
Griddle	19
CARE AND CLEANING	20
Cleaning the Glass Cooktop	20
Burned-On Residue	20
Heavy, Burned-On Residue	20
Metal marks and scratches	21
Damage from Sugary Spills and Melted Plastic	21
ACCESSORIES	21
TROUBLESHOOTING	22
LIMITED WARRANTY	27

MODEL INFORMATION

MODEL NUMBERS

ZHU36RSPSS, ZHU30RSPSS, ZHU36RDPBB,
ZHU30RDPBB

WRITE DOWN THE MODEL AND SERIAL NUMBERS

You can find them on a label under the cooktop.

These numbers are also on the Consumer Product
Ownership Registration Card packed separately with your
appliance

Please write these numbers here:

Model Number

Serial Number

Use these numbers in any correspondence or service calls
concerning your appliance.

CONSUMER SUPPORT

MONOGRAM WEBSITE

Have a question or need assistance with your appliance? Try the Monogram website 24 hours a day, any day of the year! You can also shop for more great Monogram products and take advantage of all our on-line support services designed for your convenience. In the US: monogram.com

REGISTER YOUR APPLIANCE

Register your new appliance on-line at your convenience! Timely product registration will allow for enhanced communication and prompt service under the terms of your warranty, should the need arise. You may also mail in the pre-printed registration card included in the packing material. In the US: monogram.com/register

SCHEDULE SERVICE

Expert Monogram repair service is only one step away from your door. To request service, call (800) 444-1845 or visit our website at monogram.com/contact

EXTENDED WARRANTIES

Purchase a Monogram extended warranty and learn about special discounts that are available while your warranty is still in effect. You can purchase it on-line anytime. Monogram Service will still be there after your warranty expires. In the US: monogram.com/extended-warranty

REMOTE CONNECTIVITY

For assistance with wireless network connectivity (for models with remote enable), visit our website at monogram.com/connect

PARTS AND ACCESSORIES

Individuals qualified to service their own appliances can have parts or accessories sent directly to their homes (VISA, MasterCard and Discover cards are accepted). Order on-line today 24 hours every day. In the US: monogram.com/parts

Instructions contained in this manual cover procedures to be performed by any user. Other servicing generally should be referred to qualified service personnel. Caution must be exercised, since improper servicing may cause unsafe operation.

CONTACT US

If you are not satisfied with the service you receive from Monogram, contact us on our website with all the details including your phone number, or write to:

In the US: General Manager, Customer Relations | Monogram Appliances, Appliance Park | Louisville, KY 40225
monogram.com/contact

IMPORTANT SAFETY INFORMATION

READ ALL INSTRUCTIONS BEFORE USING THE APPLIANCE

▲WARNING

Read all safety instructions before using the product. Failure to follow these instructions may result in fire, electrical shock, serious injury or death.

▲WARNING

GENERAL SAFETY INSTRUCTIONS

- Use this cooktop only for its intended purpose as described in this Owner's Manual.
- Be sure your cooktop is properly installed and grounded by a qualified installer in accordance with the provided installation instructions.
- Do not attempt to repair or replace any part of your cooktop unless it is specifically recommended in this manual. All other servicing should be performed by a qualified technician.
- Before performing any service, unplug the cooktop or disconnect the power supply at the household distribution panel by removing the fuse or switching off the circuit breaker.
- Do not leave children alone—children should not be left alone or unattended in an area where the cooktop is in use. They should never be allowed to climb, sit or stand on any part of the cooktop.
- **▲CAUTION** Do not store items of interest to children above the cooktop—children climbing on the cooktop to reach items could be seriously injured.
- Use only dry pot holders—moist or damp pot holders on hot surfaces may result in burns from steam. Do not let pot holders touch hot surface units or heating elements. Do not use a towel or other bulky cloth in place of pot holders.
- Never use your cooktop for warming or heating the room.
- Do not touch surface elements. These surfaces may be hot enough to burn even though they are dark in color. During and after use, do not touch, or let clothing or other flammable materials contact the surface elements or areas nearby the surface elements; allow sufficient time for cooling first.
- Potentially hot surfaces include the cooktop and areas facing the cooktop.
- Do not heat unopened food containers. Pressure could build up and the container could burst, causing an injury.
- Cook meat and poultry thoroughly—meat to at least an internal temperature of 160°F and poultry to at least an internal temperature of 180°F. Cooking to these temperatures usually protects against foodborne illness.

▲WARNING

KEEP FLAMMABLE MATERIALS AWAY FROM THE COOKTOP

Failure to do so may result in fire or personal injury.

- Do not store or use flammable materials near the cooktop, including paper, plastic, pot holders, linens, wall coverings, curtains, drapes and gasoline or other flammable vapors and liquids.
- Never wear loose-fitting or hanging garments while using the cooktop. These garments may ignite if they contact hot surfaces causing severe burns.
- Do not let cooking grease or other flammable materials accumulate in or near the cooktop. Grease on the cooktop may ignite.

▲WARNING

COOKTOP SAFETY INSTRUCTIONS

- In the event of a fire, do not use water or grease on fires. Never pick up a flaming pan. Turn the controls off. Smother a flaming pan on a surface unit by covering the pan completely with a well-fitted lid, cookie sheet or flat tray. Use a multi-purpose dry chemical or a foam-type fire extinguisher.
- Never leave the surface units unattended. Boilovers cause smoking and greasy spillovers that may catch on fire.
- Never leave the surface units unattended. Boilovers cause smoking and greasy spillovers that may catch on fire.
- Never leave oil unattended while frying. If allowed to heat beyond its smoking point, oil may ignite resulting in fire that may spread to surrounding cabinets. Use a deep fat thermometer whenever possible to monitor oil temperature.

READ AND SAVE THESE INSTRUCTIONS

IMPORTANT SAFETY INFORMATION

READ ALL INSTRUCTIONS BEFORE USING THE APPLIANCE

▲WARNING COOKTOP SAFETY INSTRUCTIONS (Cont.)

- To avoid spillover and fire, use a minimum amount of oil when shallow pan-frying and avoid cooking frozen foods with excessive amounts of ice.
- Use the proper pan size - select cookware having flat bottoms large enough to cover the surface heating element. The use of undersized cookware will expose a portion of the surface unit to direct contact and may result in ignition of clothing. Proper relationship of cookware to surface unit will also improve efficiency.
- To minimize the possibility of burns, ignition of flammable materials and spillage, the handle of a container should be turned toward the center of the range without extending over nearby surface units.

▲WARNING INDUCTION COOKTOP SAFETY INSTRUCTIONS

- Use care when touching the cooktop. The glass surface of the cooktop will retain heat after the controls have been turned off.
 - Do not cook on a broken cooktop. If the glass cooktop should break, cleaning solutions and spillovers may penetrate the broken cooktop and create a risk of electric shock. Contact a qualified technician immediately.
 - Avoid scratching the glass cooktop. The cooktop can be scratched with items such as knives, sharp instruments, rings or other jewelry, and rivets on clothing.
 - Do not place or store items that can melt or catch fire on the glass cooktop, even when it is not being used. If the cooktop is inadvertently turned on, they may ignite. Heat from the cooktop or oven vent after it is turned off may cause them to ignite also.
 - Use ceramic cooktop cleaner and non-scratch cleaning pad to clean the cooktop. Wait until the cooktop cools and the indicator light goes out before cleaning. A wet sponge or cloth on a hot surface can cause steam burns. Some cleaners can produce noxious fumes if applied to a hot surface. Read and follow all instructions and warnings on the cleaning cream label. **NOTE:** Sugary spills are an exception. They should be scraped off while still hot using an oven mitt and a scraper. See the Cleaning the glass cooktop section for detailed instructions.
- ▲CAUTION** Persons with a pacemaker or similar medical device should exercise caution when using or standing near an induction cooktop while it is in operation. The electromagnetic field may affect the working of the pacemaker or similar medical device. It is advisable to consult your doctor or the pacemaker manufacturer about your particular situation.

▲WARNING RADIO FREQUENCY INTERFERENCE

This unit has been tested and found to comply with the limits for a class B digital device, pursuant to Part 18 of the FCC rules. These limits are designed to provide reasonable protection against harmful interference in a residential installation. This unit generates, uses and can radiate radio frequency energy and, if not installed and used in accordance with the instructions, may cause harmful interference to radio communications. However, there is no guarantee that interference will not occur in

a particular installation. If this unit does cause harmful interference to radio or television reception, which can be determined by turning the unit off and on, the user is encouraged to try to correct the interference by one or more of the following measures:

- Reorient or relocate the receiving antennae.
- Increase the distance between the unit and receiver.
- Connect the unit into an outlet or a circuit different from that to which the receiver is connected.

How to Remove Protective Shipping Film and Packaging Tape

Carefully grasp a corner of the protective shipping film with your fingers and slowly peel it from the appliance surface. Do not use any sharp items to remove the film. Remove all of the film before using the appliance for the first time.

To assure no damage is done to the finish of the product, the safest way to remove the adhesive from packaging

tape on new appliances is an application of a household liquid dishwashing detergent. Apply with a soft cloth and allow to soak.

NOTE: The adhesive must be removed from all parts. It cannot be removed if it is baked on.

READ AND SAVE THESE INSTRUCTIONS

USING YOUR COOKTOP

Throughout this manual, features and appearance may vary from your model.

COOKTOP FEATURES

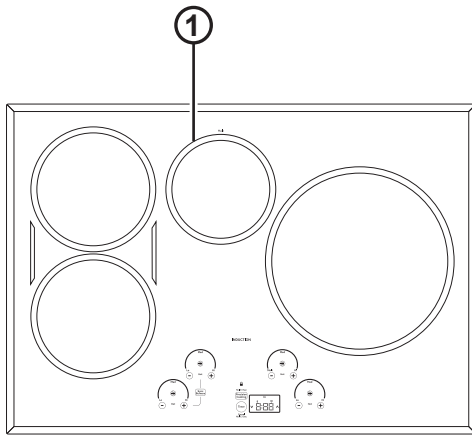

ZHU30R cooktop

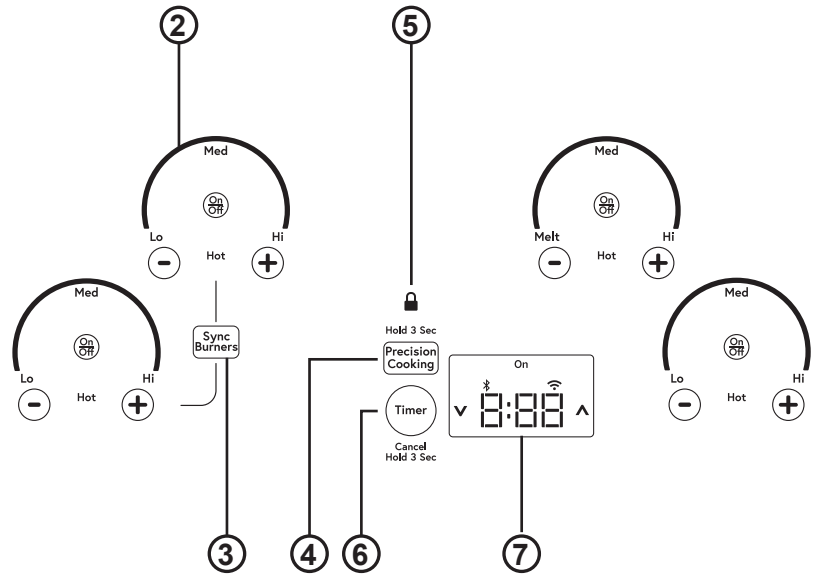

User Interface Controls

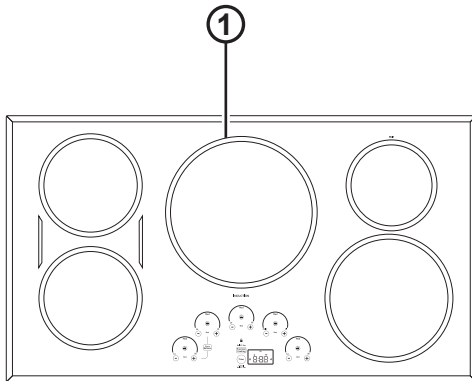

ZHU36R cooktop

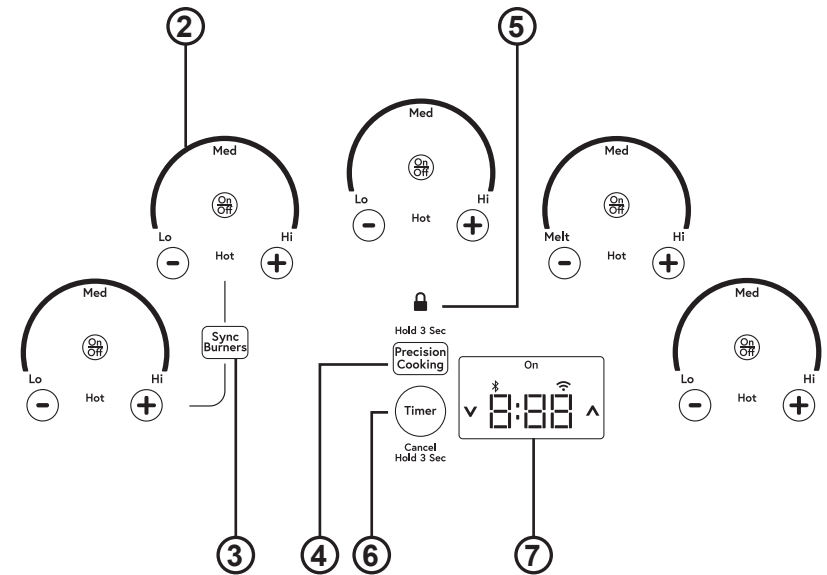

User Interface Controls

- 1. **Cooking Element(s):** See page 7.
- 2. **Power Level Arc:** See page 7.
- 3. **Sync Burners:** See page 8.
- 4. **Precision Cooking:** See page 11.
- 5. **Lock:** See page 9.
- 6. **Timer:** See page 9.
- 7. **Display:** See page 9.

USING YOUR COOKTOP

OPERATING THE COOKING ELEMENTS

Turn Burner(s) On: Touch and hold **On/Off** pad about half a second. A chime can be heard with each touch to any pad.

Power level can be selected in any of the following ways:

1. **Swipe the gray arc** (on the graphics) to the desired power level. **There is no sensor on the LEDs**, or;
2. Touch **Anywhere** along the gray arc, or;
3. Touch **+** or **-** pads to adjust power level, or;
4. Shortcut to Hi: Immediately after turning unit on, touch the **+** pad, or;
5. Shortcut to Low: Immediately after turning unit on, touch the **-** pad.

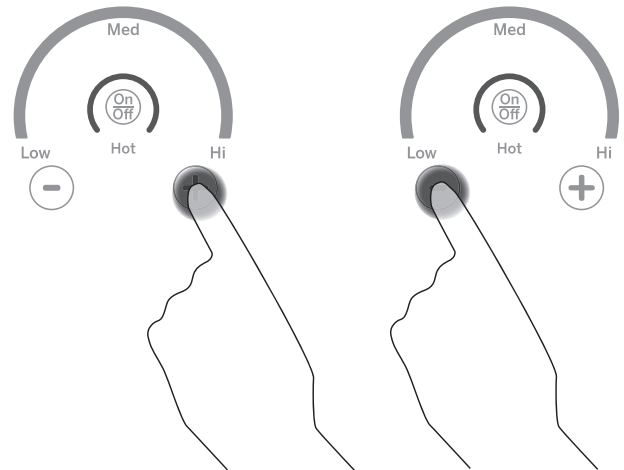
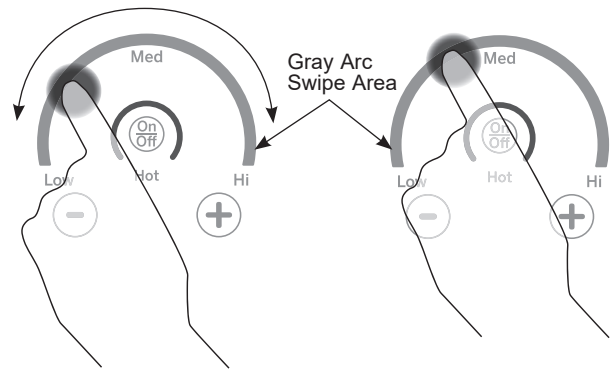
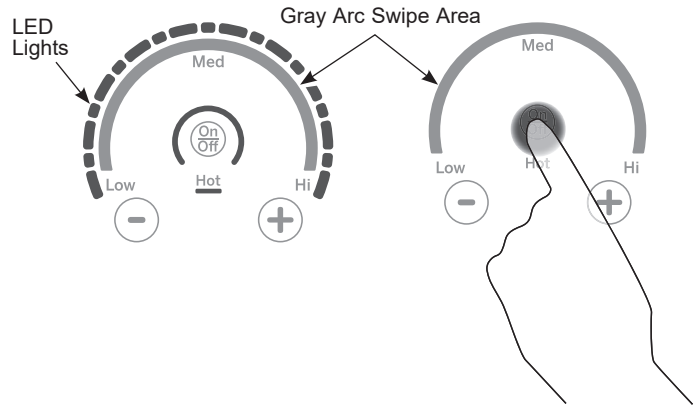

TURN BURNER(S) OFF

Touch **On/Off** pad for an individual burner.

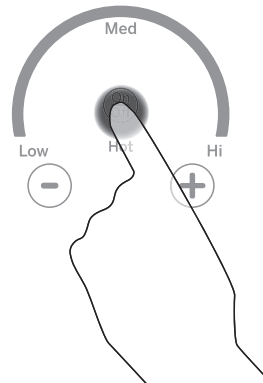

USING YOUR COOKTOP

SELECTING COOKTOP SETTINGS

Choose the element/burner that is best fit to the cookware size. Each element/burner on your new cooktop has its own power levels ranging from low to high. Power level settings necessary for cooking will vary depending on the cookware being used, the type and quantity of food, and the desired outcome. In general use lower settings for melting, holding and simmering and use higher settings for heating quickly, searing and frying. When keeping foods warm confirm selected setting is sufficient to maintain food temperature above 140°F. Larger elements and elements marked "Keep Warm" are not recommended for melting.

Hi is the highest power level, designed for large quantity rapid cooking and boiling. Hi will operate for a maximum of 10 minutes. Hi may be repeated after the initial 10 minute cycle by pressing the + pad.

CAUTION Do not place any cookware, utensils or leave excess water spills on control key pads. This may result in unresponsive touch pads and turning off the cooktop if present for several seconds.

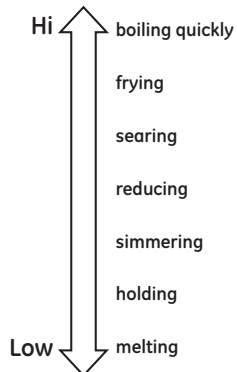

SYNCHRONIZE LEFT ELEMENTS

NOTE: Sync Burners is only intended for cookware that spans both burners.

To Turn On

Touch the **Sync Burners** pad to connect the two burners. Operate either element as previously described to adjust power level.

To Turn Off

1. Touch the **On/Off** pad on either burner to turn off the Sync Burners.
- or
2. Touch the **Sync Burners** to turn both burners off.

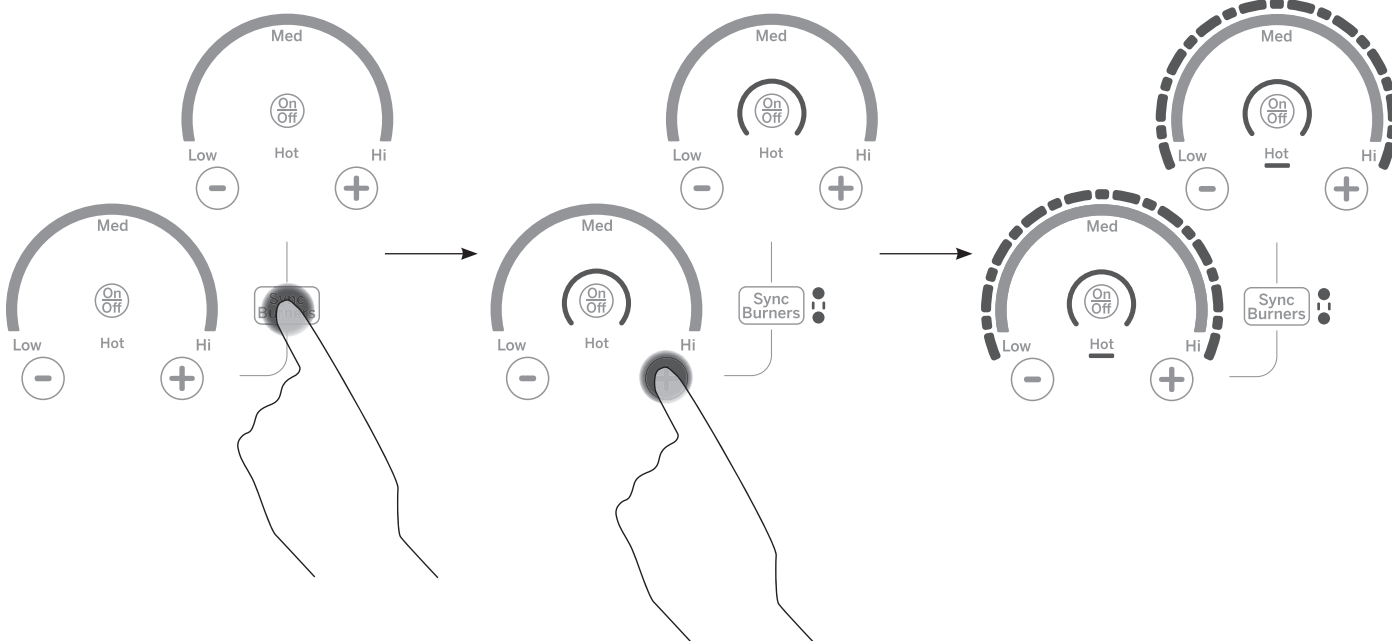

USING YOUR COOKTOP

POWER SHARING

A 36" cooktop has 3 cooking zones and a 30" cooktop has 2 cooking zones. If two elements in the same zone are in use and at least one element is at the maximum power level (Hi), the Hi setting will operate at a reduced

power level. Note that the display will not change. This is how power is shared between two elements in the same cooking zone.

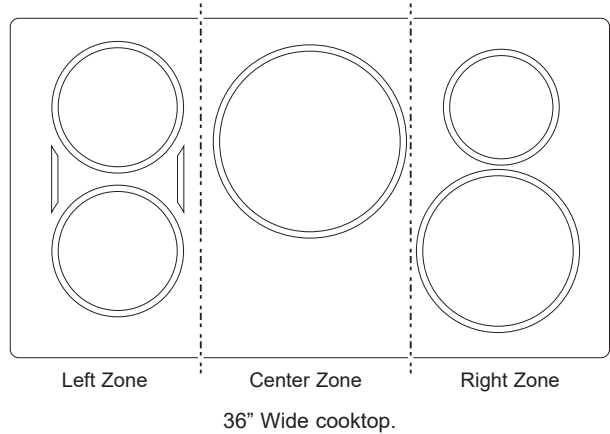
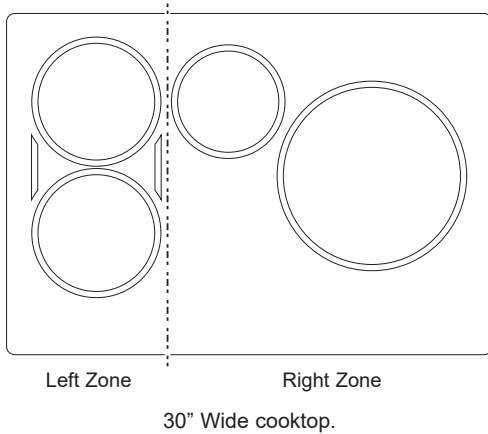

COOKTOP LOCKOUT

Lock

Touch **Control Lock** pad for 3 seconds.

To Turn Off

Touch **Control Lock** pad again for 3 seconds.

See Custom Settings section to activate Auto Lock feature.

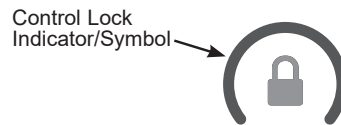

Cooktop Lockout: locks operation of the controls

SINGLE KITCHEN TIMER

To Turn On

Touch the **Timer** pad. Touch the **Λ** or **V** arrows to choose the desired number of minutes. Timer automatically starts 3 seconds after pad is touched. The "ON" LED will appear automatically when timer is set.

To Turn Off

Hold **Timer** pad for 3 seconds to cancel timer. Alarm will sound continuously when time is up until user turns timer off.

NOTE: Use the kitchen timer to measure cooking time or as a reminder. The kitchen timer does not control the cooking elements. Timer turns off if there is no activity for 30 seconds.

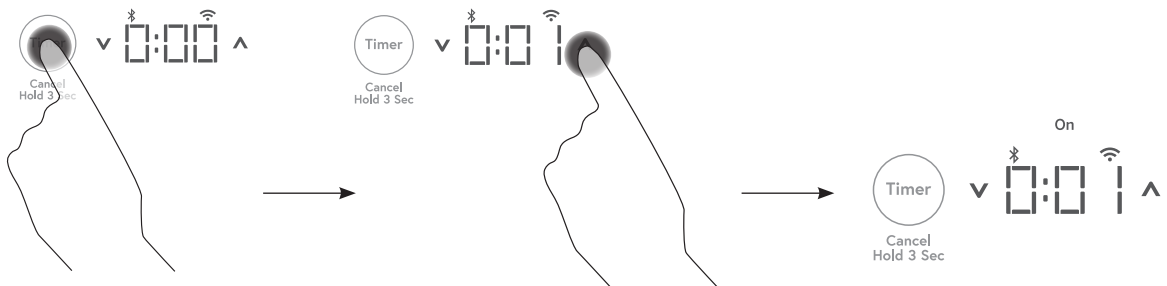

USING YOUR COOKTOP

COOKTOP COMMUNICATION MODULE SETUP (If Applicable)

Look at the underside of the cooktop in the front/left corner to see if there is an input connector jack.

If the connector jack looks like this then no further action is required, proceed to Wi-Fi Commissioning.

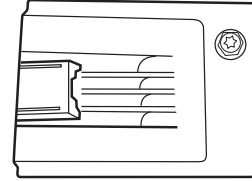
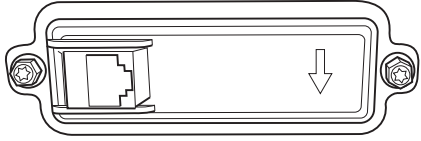

If the connector jack looks like this then refer to the instruction insert included in the literature packet titled "Important Installation Instruction Cooktop Communication Module" for setting up this device.



Wi-Fi COMMISSIONING



Turning On the Wi-Fi

Download the SmartHQ App onto your mobile device and create an account. Use the + button on the SmartHQ App homepage to add the cooktop, follow the steps in the SmartHQ App to connect Wi-Fi.

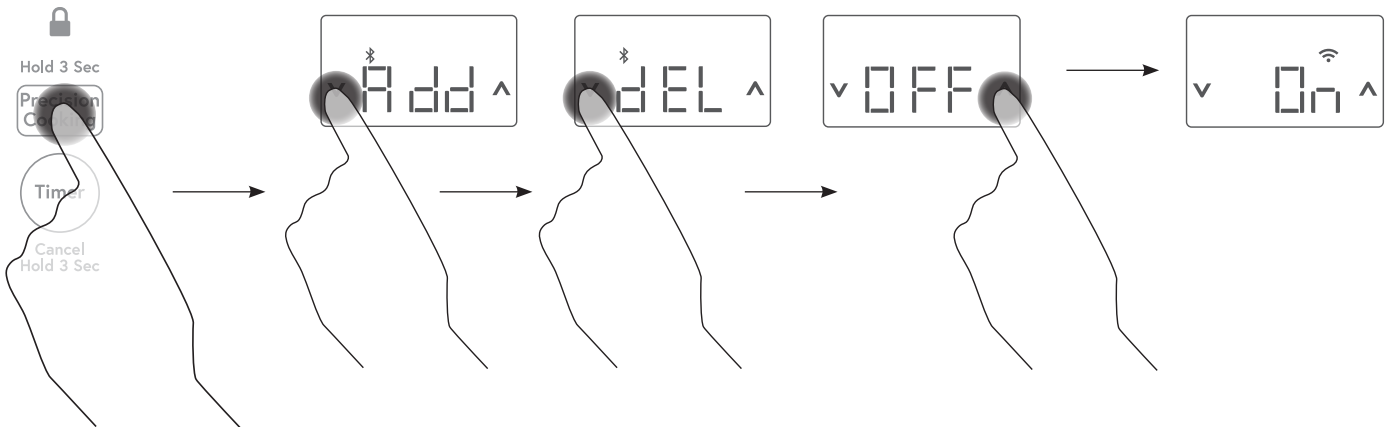
Press and hold the **Precision Cooking** button for 3 seconds until display reads "Add". Tap the **▼** twice until the display reads "Off". Tap the **▲** to turn Wi-Fi On. The  will start blinking. The  will turn solid when complete steps in the SmartHQ App. To exit Commissioning and Pairing, press **Precision Cooking** button one time, or menu will automatically exit after 60 seconds of no user input.



Turning Off the Wi-Fi

Hold the **Precision Cooking** pad for 3 seconds until display reads "Add" and Bluetooth symbol is blinking. Tap **▼** twice until the display reads "On" and the  is blinking. Tap **▲** to turn Wi-Fi Off. The  icon will turn off when complete.

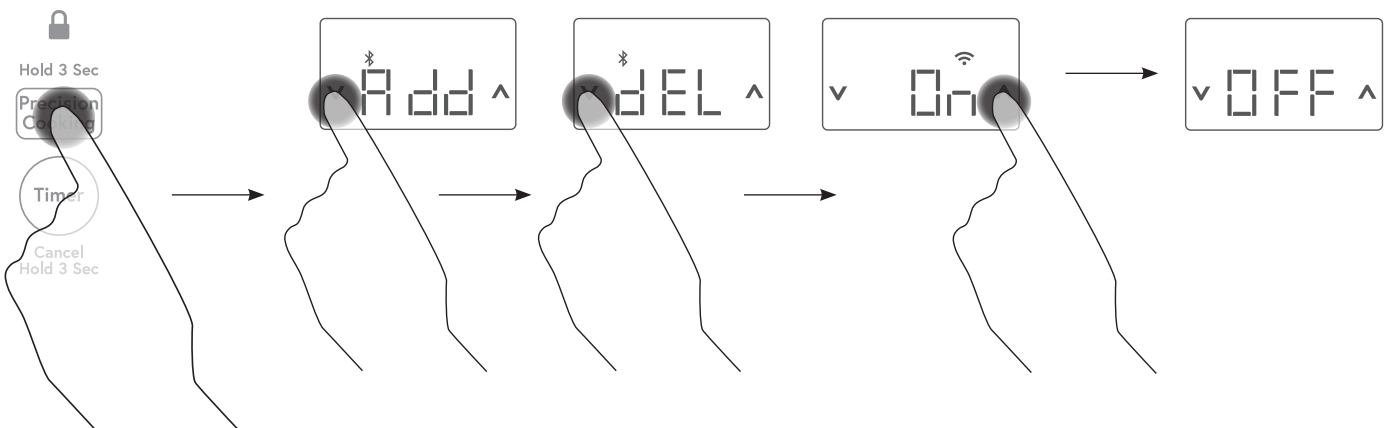

USING YOUR COOKTOP

BLUETOOTH® PAIRING

Pairing a Bluetooth® Device

Refer to the literature for the supported device to make sure it is ready to be paired. **NOTE:** The Hestan Cue® Quick Guide can be found in the literature packet.

Hold the Precision Cooking pad for 3 seconds until display reads “Add”. Tap **▲** to initiate pairing mode on the unit and **⌘** will blink, then activate your device to initiate the device’s pairing mode. Refer to the table below for device specific instructions.

Supported Devices	How to Initiate Pairing
Hestan Cue® Cookware	Tap pan handle twice
Precision Probe	Press side button once

When **⌘** stops blinking, device has been added. Repeat this step for each additional device. Up to 5 devices will be stored in memory. To exit Pairing, touch Precision Cooking pad one time, or menu will automatically exit after 60 seconds of no user input.

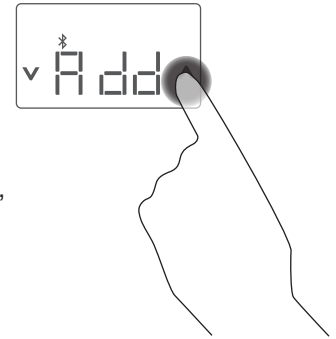

Removing Bluetooth® Devices

Hold the **Precision Cooking** pad for 3 seconds until display reads “Add”. Tap **▼** so that display shows “dEL”, then tap **▲** to delete all paired devices. The **⌘** icon will turn off when complete. **NOTE:** Your unit cannot delete a single, or specific device. All of your paired device will be deleted simultaneously. After all devices are cleared, devices you wish to use must be paired again.

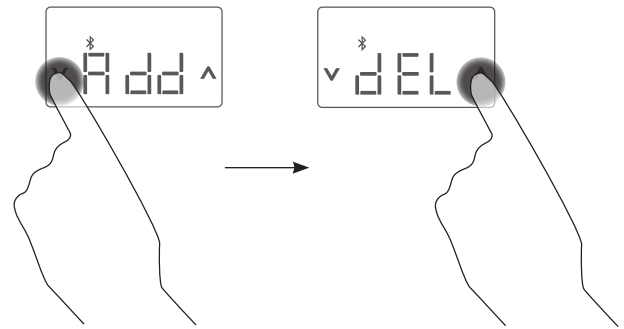

PRECISION COOKING

The Precision Cooking feature allows precise temperature control of certain cooking devices for improved results.

Initiating a Precision Cooking Mode

1. Touch the **Precision Cooking** pad.
2. Any burner available for Precision Cooking will flash. This excludes any burner on in standard mode. If no Precision Cooking devices are paired, no burners will flash as available. **NOTE:** Only one burner may run a Precision Cooking mode at a time. If another precision mode is attempted, the burner in use for Precision Cooking will flash.
3. The display will read “SEL”, instructing you to select a burner to use.

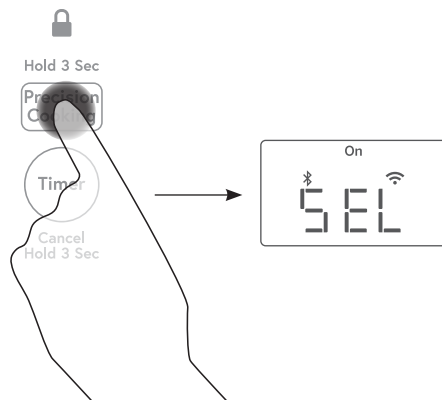

4. Touch the **On/Off** pad for the desired burner, or press **Sync Burners** to use Precision Cooking across the two left burners.

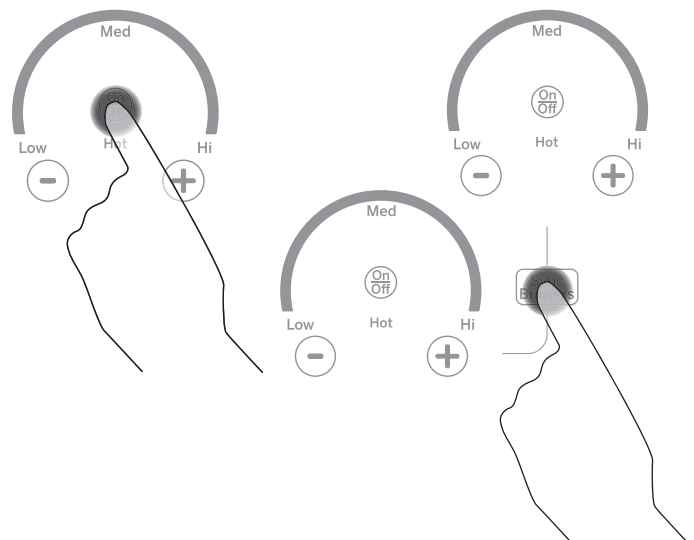

USING YOUR COOKTOP

PRECISION COOKING (Cont.)

Activating a Precision Cooking Device

1. The unit must identify which device you intend to use to adjust control parameters appropriately.
2. The display will read “Act”, instructing you to activate a device to use on the previously selected burner.
3. Activation instructions for approved devices are listed in the table below.

Supported Devices	How to Activate	Control with this App
Hestan Cue® Cookware	Tap pan handle	Hestan Cue® (by Hestan Smart Cooking)
Precision Probe	Press side button once	SmartHQ App

NOTE: Hestan Cue® cookware can also be controlled through the (SmartHQ App), but functionality is limited to temperature control only.

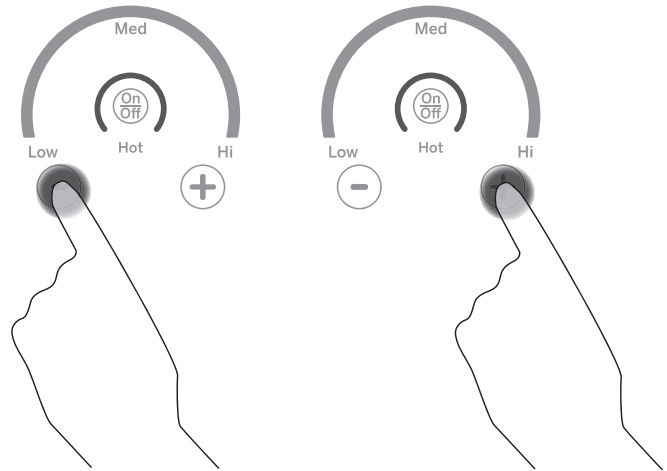
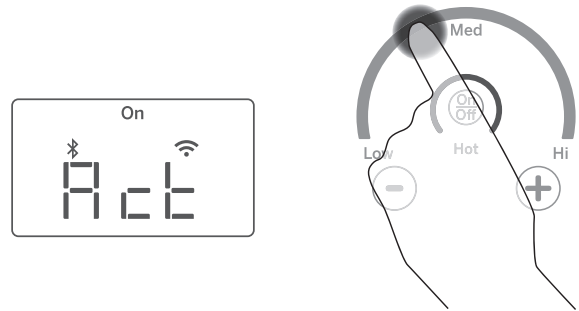

Precision Cooking Control Modes

There are two control modes available:

- **App Control** – the user interacts with an application on a smart phone.
- **Local Control** – the user interacts with the burner to set a target temperature and no App use is required.

App Control

After activating your device on your selected burner, open the App designed to control the selected device. Depending on the device and application, the set temperature may be shown in the unit display, in the App, or hidden from view.

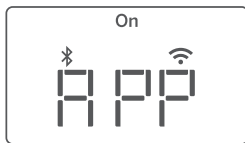

Local Control

After activating your device on your selected burner, tap on the burner ring to set the approximate temperature. Small adjustments can be made by tapping the + or – pads. The set temperature will be shown in the display. **NOTE:** Use of App Control mode is blocked upon entering Local Control mode.

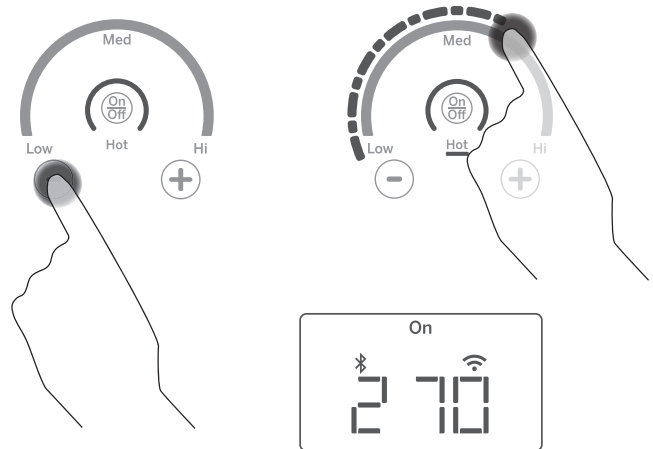

USING YOUR COOKTOP

PRECISION COOKING (Cont.)

Display Priority

To toggle the display, touch the **Precision Cooking** pad to display set temperature, and touch the **Timer** pad to display the kitchen timer. The kitchen timer remains editable by using **▲** and **▼** within the display, but a set temperature is not editable here. Go to App if in App Control, or burner in Local Control, to adjust temperature. **NOTE:** Timer is in hours and minutes, H:MM.

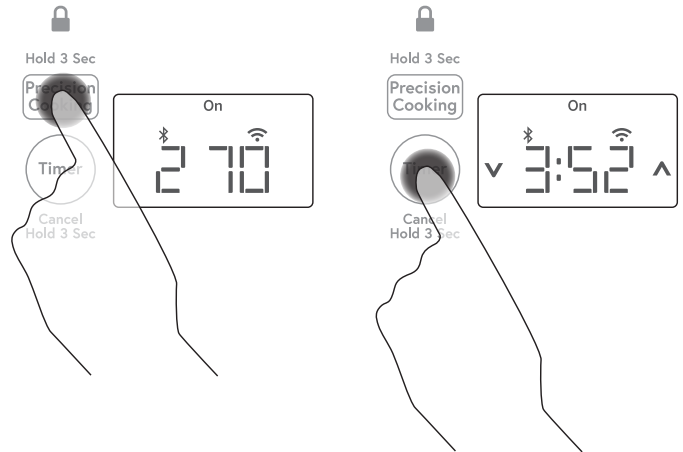

Precision Cooking – Sync Burners

NOTE: Sync Burners is only intended for cookware that spans both burners.

To start a Precision Cooking mode using the sync burners feature, touch the **Precision Cooking** pad, then touch the **Sync Burners** pad. When the display reads “APP”, you can now use either App Control or Local Control. For App Control, open the App designed to control the selected device. For Local Control, tap either burner ring to set the approximate temperature, which will be reflected on left front and left rear elements. Small adjustments can be made by tapping the **+** or **-** pads. The set temperature will be shown in the display.

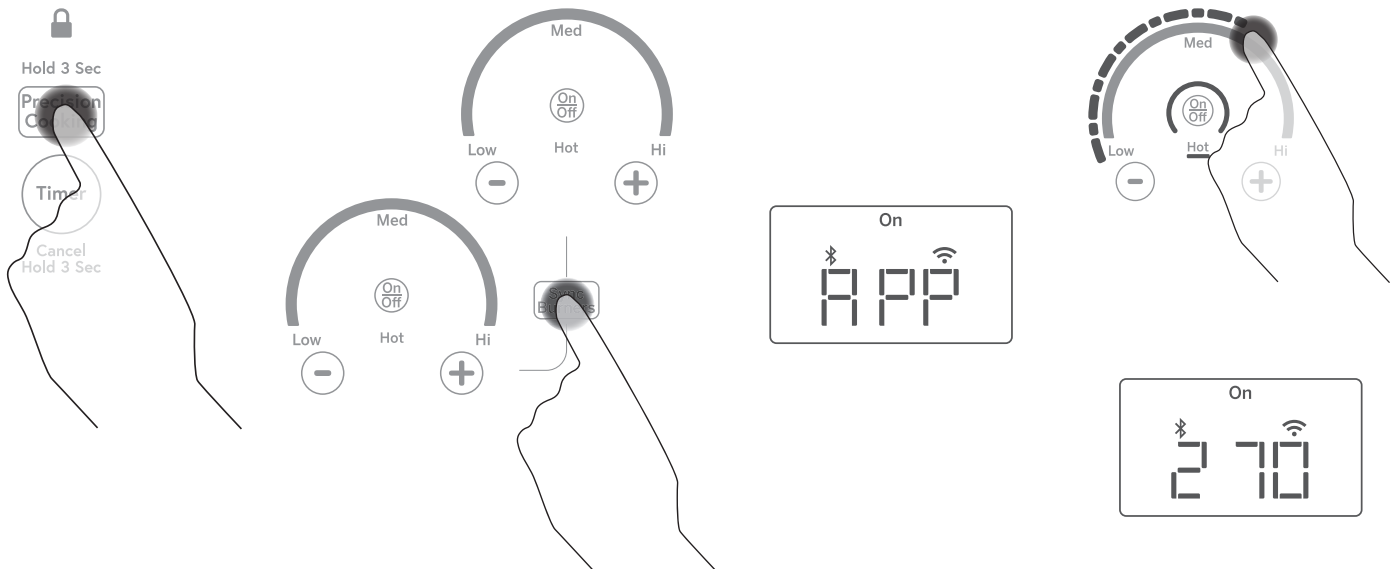

USING YOUR COOKTOP

HOT LIGHT INDICATOR

A hot surface indicator light (one for each cooking element) will glow when the glass surface is hot and will remain on until the surface has cooled to a temperature that is safe to touch.

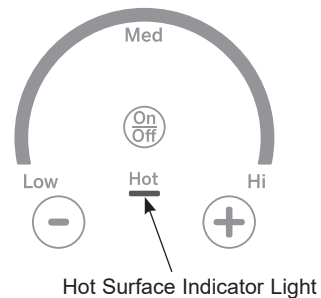

PAN DETECTION REMOVAL

When a pan is removed from the cooktop surface, Burner level turns off; Power arc starts to blink. If a pan is not detected for 25 seconds, the control turns off automatically, lights turn off.

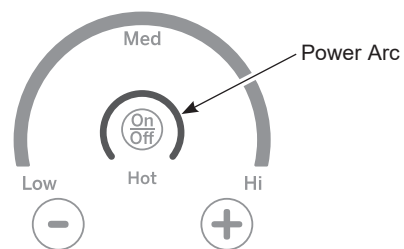

USING YOUR COOKTOP

CUSTOM SETTINGS

1. Press and hold **All Off** pad for 3 seconds, then immediately press and hold the **Timer** pad for 3 seconds to enter custom settings. Those two pads must be pressed within 30 seconds. Any other pad will cancel mode.
2. “C - -” appears on display. To navigate through the Custom Settings, use the **▲** (up) or **▼** (down) pads. If **▲** (up) is selected the display cycle starts at “C01”. If **▼** (down) is selected, the display cycle starts at “C62”.
3. To activate a new Custom Setting the user will touch and hold the **Timer** pad for 3 sec. Only ONE of the Custom Setting Choices can be activated for each Custom Setting. The red “On” LED will turn on and a sound will go off once a new custom setting is activated.
4. The cooktop will exit Custom Settings if it is inactive for 3 minutes.
5. To exit Custom Settings and save any changes, touch and hold the **All Off** pad for 3 seconds.

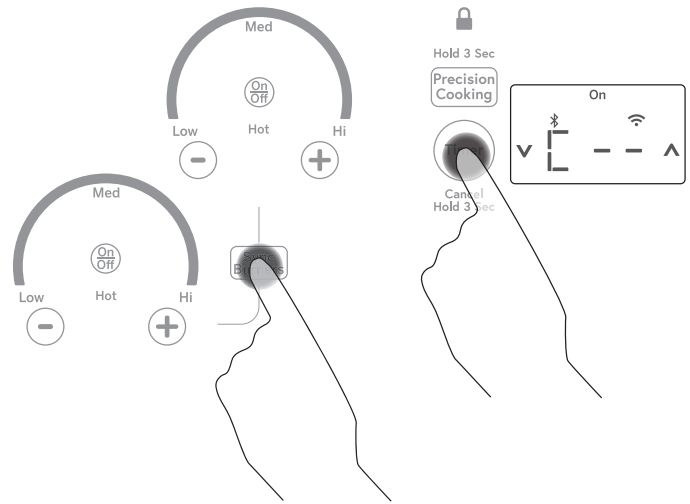

Custom Settings Chart

Custom Settings	Custom Setting Choices
C0 (Factory Settings)	C01 - Factory Reset (Clears customized settings and restores defaults)
	C02 - Custom settings activated (Not visible unless any other custom setting is selected. And automatically on when any other custom setting is selected. Not selectable by user.)
C1 (Control Lock)	C11 - Standard Lock (ie; Only on when lock button pressed for 3 seconds.) If using a timer, Control Lock is unavailable.
	C12 - Auto Lock (ie; Engages after cooktop has been in standby mode for 10 minutes.) The unit should be completely off to go into Auto Lock.
C2 (LED light level)	C21 - Full illumination
	C22 - Medium illumination
	C23 - Lowest illumination
C3 (Button Loudness)	C31 - All sounds activated at 100% (For alarm sounds, 100% = Whatever level is set in c4.)
	C32 - Button sound level reduced by 50%, Alarm sounds at 100%
	C33 - Button sounds deactivated, Alarm sounds activated at 100%
C4 (Timer Alarm Loudness)	C41 - High
	C42 - Low
C5 (Timer Alarm Duration)	C51 - Indefinite (ie; alarm continues until cancelled by user).
	C52 - Alarm sounds for 60 seconds.
	C53 - Alarm sounds for 30 seconds.
	C54 - Alarm sounds for 15 seconds.

* Options in grey are default settings

USING YOUR COOKTOP

HOW INDUCTION COOKING WORKS

The magnetic fields induce a small current in the pan. The pan acts as a resistor, which produces heat, much like a radiant coil.

The cooking surface itself does not heat. Heat is produced in the cooking pan, and cannot be generated until a pan is placed on the cooking surface.

When the element is activated, the pan begins to heat immediately and in turn heats the contents of the pan.

Magnetic induction cooking requires the use of cookware made of ferrous metals—metals to which magnets will stick, such as iron or steel.

Use pans that fit the element size. The pan must be large enough for the safety sensor to activate an element.

The cooktop will not operate if a very small steel or iron utensil (less than the minimum size across the bottom) is placed on the cooking surface when the unit is turned on—items such as steel spatulas, cooking spoons, knives and other small utensils.

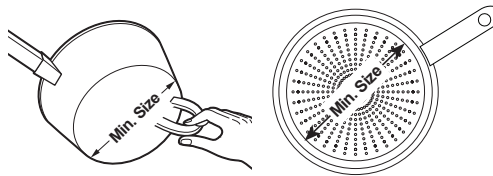

Use the minimum size pan for the element. The pan material is correct if a magnet sticks to the bottom.

COOKWARE “NOISE”

Slight sounds may be produced by different types of cookware. Heavier pans such as enameled cast iron produce less sound than a lighter weight multi-ply stainless steel pan. The size of the pan, and the amount of contents, can also contribute to the sound level.

When using adjacent elements that are set at certain power level settings, magnetic fields may interact and produce a high pitch whistle or intermittent “hum”. These sounds can be reduced or eliminated by lowering or raising the power level settings of one or both of the elements. Pans that completely cover the element ring will produce less sound.

A low “humming” sound is normal particularly on high settings.

Sounds you may hear: You may hear a slight “Buzz” when cooking with Hi mode. This is normal. The sound depends on the type of pot being used. Some pots will “Buzz” louder depending on the material. A “Buzz” sound may be heard if the pan contents are cold. As the pan heats, the sound will decrease. If the power level is reduced, the sound level will go down.

Pans that do not meet the minimum size requirements for the burner can produce louder sounds. They can cause the controller to “search” for the pot and produce a clicking and “zipping” sound. This can happen when one burner is running or only when an adjacent burner is also running. See User Manual for the minimum sized pots for each burner. Only measure the flat, magnetic bottom of the pot.

USING YOUR COOKTOP

CHOOSING THE CORRECT COOKWARE TO USE

Using the correct size cookware

The induction coils require a minimum pan size to function properly. If the pan is removed from the element for more than 25 seconds or not detected the ON indicator for that element will flash and then turn off.

Cookware larger than the element ring may be used; however, heat will only occur above the element.

For best results, the cookware must make FULL contact with the glass surface.

Do not allow the bottom of the pan or cookware to touch the surrounding metal cooktop trim or to overlap the cooktop controls.

For best performance, match the pan size to the element size. Using a smaller pot on a larger burner will generate less power at any given setting.

Suitable Cookware

Use quality cookware with heavier bottoms for better heat distribution and even cooking results. Choose cookware made of magnetic stainless steel, enamel coated cast iron, enameled steel and combinations of these materials.

Some cookware is specifically identified by the manufacturer for use with induction cooktops. Use a magnet to test if the cookware will work.

Flat-bottomed pans give best results. Pans with rims or slight ridges can be used.

Round pans give best results. Pans with warped or curved bottoms will not heat evenly.

For wok cooking, use a flat-bottomed wok. Do not use a wok with a support ring.

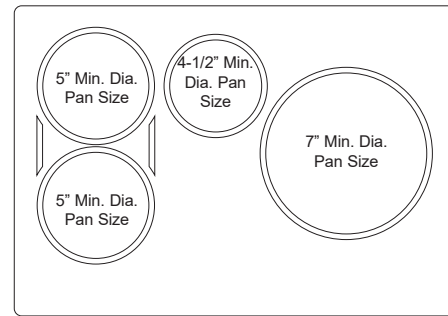

30" wide cooktop.
Use the minimum recommended size pan shown for each cooking element.

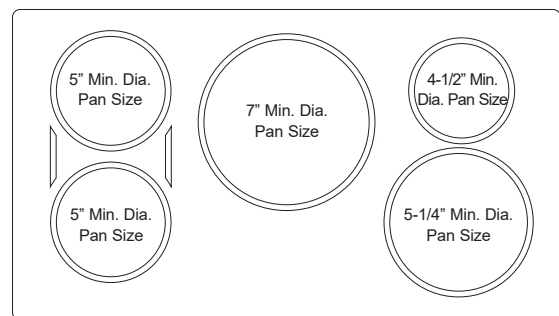

36" wide cooktop.
Use the minimum recommended size pan shown for each cooking element.

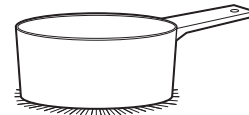

Use flat-bottomed pans.

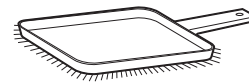

Use a griddle.



Use a flat-bottomed wok.

USING YOUR COOKTOP

CHOOSING THE CORRECT COOKWARE TO USE (Cont.)

Cookware recommendations

Cookware must fully contact the surface of the cooking element.

Use flat-bottomed pans sized to fit the cooking element and also to the amount of food being prepared.

Induction interface disks are NOT recommended.

Precision Device Minimum Temperatures

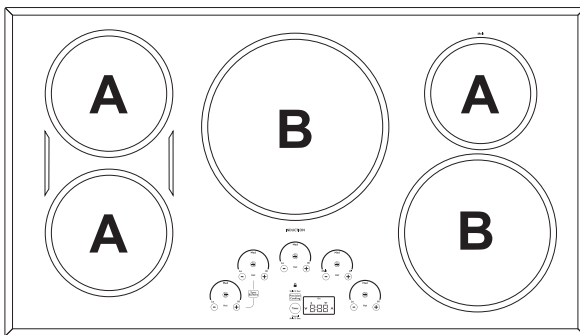
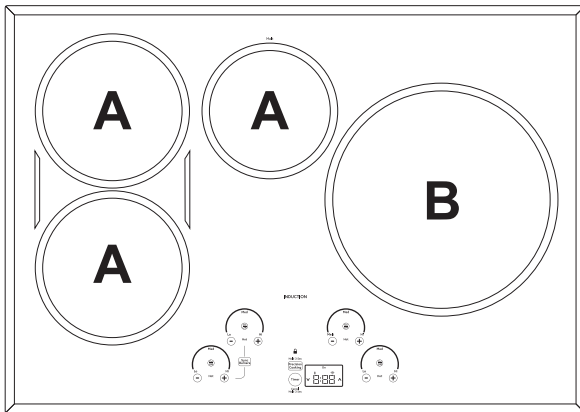

Device temperature ranges are dependent on burner size:

Device	Small to Medium Burners (A)	Large Burners (B)
Hestan Cue® cookware	100°F – 500°F	150°F – 500°F
Precision Probe	100°F – 200°F	120°F – 200°F

Using the Precision Probe at low temperatures

If you are experiencing trouble maintaining lower set temperatures with a precision probe, try changing your set-up by:

- Remove the lid from the pot
- Use a larger diameter pot
- Use a smaller burner with a pot larger than the burner

INCORRECT

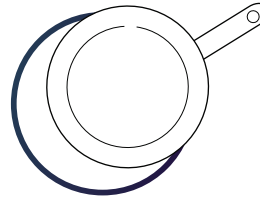

Cookware not centered on cooking element surface.

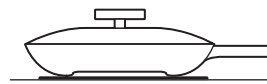

Curved or warped pan bottoms or sides.

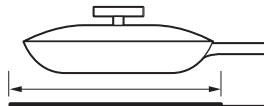

Pan does not meet the minimum size required for the cooking element used.



Pan bottom rests on cooktop trim or does not rest completely on the cooktop surface.



Heavy handle tilts pan.

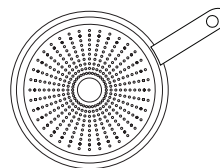

Pan is partially magnetic on the bottom.

CORRECT

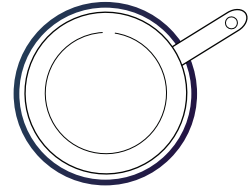

Cookware centered correctly on cooking element surface.

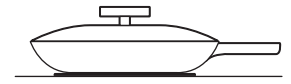

Flat pan bottom.

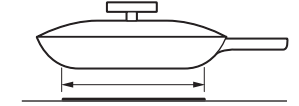

Pan size meets or exceeds the recommended minimum size for the cooking element used.

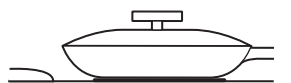

Pan bottom rests completely on the cooktop surface.



Pan is properly balanced.

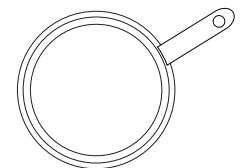

Pan is completely magnetic on the bottom.

USING YOUR COOKTOP

GRIDDLE

Using the Griddle

CAUTION Burn Hazard

- Griddle surfaces may be hot enough to cause burns during and after use. Place and remove the griddle when it is cool and all surface units are off. Use oven mitts if you will touch the griddle while hot. Failure to do so can result in burns.
- Place and remove the griddle only when griddle is cool and all surface burners are turned OFF.

Before using this cookware for the first time, wash it to make sure it is clean. Then season it lightly, rubbing cooking oil onto the cooking surface.

How To Place The Griddle

IMPORTANT: Always place and use your griddle at the designated location on the cooktop.

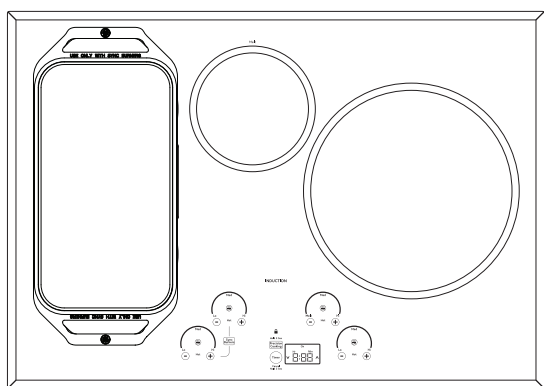

IMPORTANT NOTES:

- Clean the griddle with a sponge and mild detergent in warm water. DO NOT use blue or green scrubbing pads or steel wool.
- Avoid cooking extremely greasy foods and be careful of grease spillover while cooking.
- Never place or store any items on the griddle, even when it is not in use. The griddle can become heated when using the surrounding surface units.
- Avoid using metal utensils with sharp points or rough edges, which might damage the griddle. Do not cut foods on the griddle.
- Do not use cookware as a storage container for food or oil. Permanent staining and/or craze lines could result.
- Your griddle will discolor over time with use.
- Do not clean the griddle in a self-cleaning oven.
- Always allow the cookware to cool before immersing in water.
- Do not overheat the griddle.

Type of Food	Cook Setting
Warming Tortillas	Med-Lo
Pancakes	Med-Lo
Hamburgers	Med
Fried Eggs	Med-Lo
Breakfast Sausage Links	Med
Hot Sandwiches (such as Grilled Cheese)	Med-Lo

Griddle settings are intended to be a guideline and may need to be adjusted based on individual cooking preferences.

Griddle Operation

To turn on the surface units for the entire griddle, use the Sync Burner control feature. Touch the **Sync Burner** pad and then adjust power level to desired setting as described on page 8.

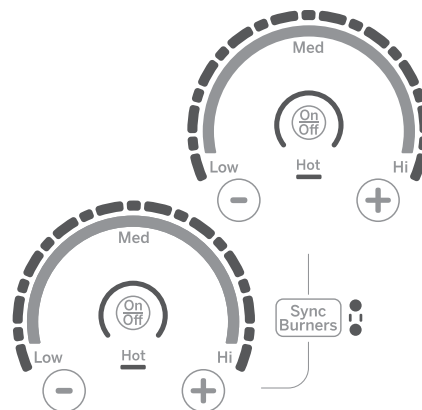

CARE AND CLEANING

CLEANING THE GLASS COOKTOP

To maintain and protect the surface of your glass cooktop, follow these steps:

1. Before using the cooktop for the first time, clean it with a ceramic cooktop cleaner. This helps protect the top and makes cleanup easier.
2. Regular use of a ceramic cooktop cleaner will help keep the cooktop looking new.
3. Shake the cleaning cream well. Apply a few drops of a ceramic cooktop cleaner directly to the cooktop.
4. Use a paper towel or a non-scratch cleaning pad for ceramic cooktops to clean the entire cooktop surface.
5. Use a dry cloth or paper towel to remove all cleaning residue. No need to rinse.

NOTE: It is very important that you DO NOT heat the cooktop until it has been cleaned thoroughly.

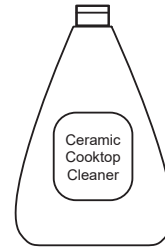

Clean your cooktop after each spill. Use a ceramic cooktop cleaner.

BURNED-ON RESIDUE

NOTE: DAMAGE to your glass surface may occur if you use scrub pads other than those recommended.

1. Allow the cooktop to cool.
2. Spread a few drops of a ceramic cooktop cleaner on the entire burned residue area.
3. Using a non-scratch cleaning pad for ceramic cooktops, rub the residue area, applying pressure as needed.
4. If any residue remains, repeat the steps listed above as needed.

5. For additional protection, after all residue has been removed, polish the entire surface with a ceramic cooktop cleaner and a paper towel.

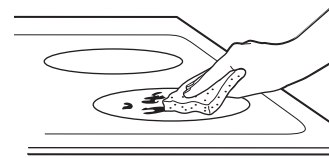

Use a non-scratch cleaning pad for ceramic cooktops.

HEAVY, BURNED-ON RESIDUE

1. Allow the cooktop to cool.
2. Use a single-edge razor blade scraper at approximately a 45° angle against the glass surface and scrape the soil. It will be necessary to apply pressure to the razor scraper in order to remove the residue.
3. After scraping with the razor scraper, spread a few drops of a ceramic cooktop cleaner on the entire burned residue area. Use a non-scratch cleaning pad to remove any remaining residue.
4. For additional protection, after all residue has been removed, polish the entire surface with a ceramic cooktop cleaner and a paper towel.

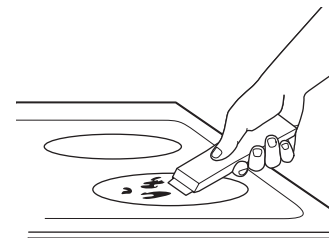

The ceramic cooktop scraper and all recommended supplies are available through our Parts Center. See instructions under "Assistance / Accessories" section.

NOTE: Do not use a dull or nicked blade.

CARE AND CLEANING

METAL MARKS AND SCRATCHES

1. Be careful not to slide pots and pans across your cooktop. It will leave metal markings on the cooktop surface.

These marks are removable using a ceramic cooktop cleaner with a non-scratch cleaning pad for ceramic cooktops.

2. If pots with a thin overlay of aluminum or copper are allowed to boil dry, the overlay may leave black discoloration on the cooktop.

This should be removed immediately before heating again or the discoloration may be permanent.

NOTE: Carefully check the bottom of pans for roughness that would scratch the cooktop.

DAMAGE FROM SUGARY SPILLS AND MELTED PLASTIC

Special care should be taken when removing hot substances **to avoid permanent damage of the glass surface**. Sugary spillovers (such as jellies, fudge, candy, syrups) or melted plastics can cause pitting of the surface of your cooktop (not covered by the warranty) unless the spill is removed while still hot. Special care should be taken when removing hot substances.

Be sure to use a new, sharp razor scraper.

Do not use a dull or nicked blade.

1. Turn off all surface units. Remove hot pans.

2. Wearing an oven mitt:

- a. Use a single-edge razor blade scraper to move the spill to a cool area on the cooktop.
- b. Remove the spill with paper towels.

3. Any remaining spillover should be left until the surface of the cooktop has cooled.

4. Don't use the surface units again until all of the residue has been completely removed.

NOTE: If pitting or indentation in the glass surface has already occurred, the cooktop glass will have to be replaced. In this case, service will be necessary.

ACCESSORIES

Looking For Something More?

Monogram offers a variety of accessories to improve your cooking and maintenance experiences!

Refer to the Consumer Support page for website information.

The following products and more are available:

Parts

Griddle

Sous Vide Kit

Stainless Steel Cleaner and Polisher

TROUBLESHOOTING

Save time and money! Review the charts on the following pages first and you may not need to call for service.

Problem	Possible Causes	What To Do
Surface elements will not maintain a rolling boil or cooking is slow	Improper cookware being used.	Use pans that are recommended for induction, have flat bottoms and match the size of the surface element.
Surface elements do not work properly	Cooktop controls improperly set.	Check to be sure the correct control is set for the surface element you are using.
Power arc ON indicator blinking	Wrong pan type.	Use a magnet to check that cookware is induction compatible.
	Pan is too small.	Blinking "ON" indicator — pan size is below the minimum size for the element. See the Using the correct size cookware section.
	Pan not positioned correctly.	Center the pan in the cooking ring.
	+, -, or control lock pads have been touched before an element is turned on.	See the Operating the Cooking Elements section.
Scratches on cooktop glass surface	Incorrect cleaning methods being used.	Use recommended cleaning procedures. See the Cleaning the glass cooktop section.
	Cookware with rough bottoms being used or coarse particles (salt or sand) were between the cookware and the surface of the cooktop. Cookware has been slid across the cooktop surface.	To avoid scratches, use the recommended cleaning procedures. Make sure bottoms of cookware are clean before use, and use cookware with smooth bottoms.
Areas of discoloration on the cooktop	Food spillovers not cleaned before next use.	See the Cleaning the glass cooktop section.
	Hot surface on a model with a light-colored glass cooktop.	This is normal. The surface may appear discolored when it is hot. This is temporary and will disappear as the glass cools.
Plastic melted to the surface	Hot cooktop came into contact with plastic placed on the hot cooktop.	See the Glass surface – potential for permanent damage section in the Cleaning the glass cooktop section.
Pitting (or indentation) of the cooktop	Hot sugar mixture spilled on the cooktop.	Call a qualified technician for replacement.
Unresponsive keypad	Keypad is dirty.	Clean the keypad.
	A fuse in your home may be blown or the circuit breaker tripped.	Replace the fuse or reset the circuit breaker.
Pan detection/sizing not working properly	Improper cookware being used.	Use a flat induction capable pan that meets the minimum size for the element being used. See the Using The Correct Size Cookware section.
	Pan is improperly placed.	Make sure the pan is centered on the corresponding surface element.
	Cooktop control improperly set.	Check to see that the control is set properly.
Noise	Sounds you may hear: Buzzing, whistling and humming.	These sounds are normal. See Cooking Noise section.

TROUBLESHOOTING

Problem	Possible Causes	What To Do
Precision Cooking button beeps error tone when pressed one time	There is no precision cooking device paired, so you are unable to start a precision cooking mode.	Connect a precision cooking device.
Probe actual temperature is not stable while charger is inserted	Electrical noise is impacting the signal.	Probe should be charged before cooking. Do not leave probe plugged in while cooking.
My sous vide probe JXSOUV1 won't pair	Existing precision probes are not compatible with new precision features.	Connect a model compatible precision probe.
My precision probe is not accurately maintaining low temperatures	The pot size, pot set-up, and/or burner size you are using may be unsuitable to hold low temperatures.	Remove the lid, use a larger diameter pot, or use a smaller burner. Please keep your unit connected and install upcoming updates to improve performance.
Pan won't pair or activate when tapping handle	Tapping force is too light.	Double tap the pan with firm taps (or knock) on the black plastic endcap.
	Battery in pan is low or dead.	Replace AAA battery, installing with positive end out of handle.
	Using different pan hardware.	Check that your pan has a black endcap that unscrews from the end of the handle. Pans with an oval module reading "Hestan Cue®" will not work with Café appliances.
Experiencing performance or minor technical issues including seeing 20F or 100F as set temperature	Old unit or pan software.	Connect your unit to the SmartHQ app and update unit software. Connect your unit and pan to the Hestan Smart Cooking app and update pan software.
The unit cancelled my precision cooking mode	Battery in device is low or dead.	Replace AAA battery in pan, or charge probe.
	Old unit or pan software.	Connect your unit to the SmartHQ app and update unit software. Connect your unit and pan to the Hestan Smart Cooking app and update pan software.
	Your precision cooking device has gone out of range.	This could indicate a problem with the device. If the problem persists, please contact the device manufacturer.
	Your precision cooking device had a computation malfunction.	
	The unit lost communication with your precision cooking device.	This could indicate a problem with the device or the unit. If the problem persists, please contact the device or unit manufacturer.
	Some cooking techniques and set temperatures in combination may trigger a fault in the temperature sensing algorithm.	Re-start the precision cooking mode and if problem persists under the same conditions but is not consistent in other use cases, contact the unit manufacturer.

NOTES

NOTES

NOTES

LIMITED WARRANTY

Monogram.com

All warranty service is provided by our Factory Service Centers, or an authorized Customer Care® technician. To schedule service online, visit us at **monogram.com** or call Monogram Preferred Service (800.444.1845). Please have your serial number and your model number available when calling for service. In Canada, visit **monogram.ca**.

For the period of	Monogram Appliances will replace
Limited two-year warranty	For two years from date of original purchase, we will provide, free of charge, parts and service labor in your home to repair or replace any part of the appliance that fails because of a manufacturing defect.

What Monogram will not cover:

- Service trips to your home to teach you how to use the product.
- Improper installation, delivery or maintenance.
- Failure of the product if it is abused, misused, modified or used for other than the intended purpose or used commercially.
- Replacement of house fuses or resetting of circuit breakers.
- Damage to the product caused by accident, fire, floods or acts of God.
- Incidental or consequential damage caused by possible defects with this appliance.
- Damage caused after delivery.
- Product not accessible to provide required service.
- Service to repair or replace light bulbs, except for LED lamps.

EXCLUSION OF IMPLIED WARRANTIES

Your sole and exclusive remedy is product repair as provided in this Limited Warranty. Any implied warranties, including the implied warranties of merchantability or fitness for a particular purpose, are limited to one year or the shortest period allowed by law.

This limited warranty is extended to the original purchaser and any succeeding owner for products purchased for home use within the USA. If the product is located in an area where service by an Authorized Servicer is not available, you may be responsible for a trip charge or you may be required to bring the product to an Authorized Service location. In Alaska, the limited warranty excludes the cost of shipping or service calls to your home.

Some states do not allow the exclusion or limitation of incidental or consequential damages. This limited warranty gives you specific legal rights, and you may also have other rights which vary from state to state. To know what your legal rights are, consult your local or state consumer affairs office or your state's Attorney General.

Warrantor: GE Appliances, a Haier company
Louisville KY,40225

Staple your receipt here. Proof of the original purchase date is needed to obtain service under the warranty.

