

24" DISTINTO DRAWER MICROWAVE







MICROWAVE OVEN



CODE ID

F7DMW24S2



-  Sensor Cooking
-  Power Selection
-  Touch Controls
-  Presets
-  950 Watts
-  Auto Defrost
-  Child Safety Lock

SPECIFICATIONS

FEATURES

- Flexible installation
- Stainless steel design
- Modern edge-to-edge black glass
- LED interior lighting
- Touchless opening of the microwave drawer
- Touch glass controls are easy-to see and operate at a convenient 45° angle
- Built-in airflow control for flush mounting
- transparent door glass
- Accessible height allows you to easily lift hot foods

DISTINTO

24" DRAWER MICROWAVE

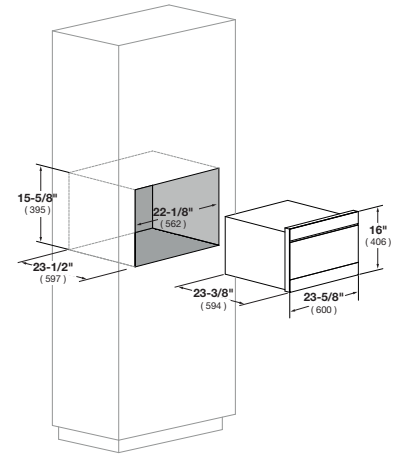

CODE ID	24" BUILT-IN MICROWAVE - F7DMW24S2
MW Types	Drawer
Drawer Opening	"Easy Wave Open" Motion Sensor or Open/Close Button
Finish	Stainless Steel / Black Glass
Oven Floor	Patterned Glass
CONTROL PANEL	
Control Panel Location	Center Top
Control Panel Type	Glass Touch
Display Type	LCD
Display Color	White on Black Background
CAPACITIES	
Cavity Size (cu.ft)	1.2
FEATURES	
Timer/Setting	•
Power Selection	11 levels
Output Power (watts)	950
Interior Light	LED
Start/+30 Sec	•
Clock	•
Multi-Stage Cooking	4
Control Lock	•
Demo Mode	•
Microwave ON Indicator	•
End of Cooking Reminder	•
Auto Start	•
Standby Mode	•
Sensor	Popcorn / Reheat
Sensor Cook Menu	11 (Baked Potatoes, Sweet Potatoes, Fish/ Seafood, Brown Rice, White Rice, Quick Fresh Vegetables, Longer Fresh Vegetables, Steamer Bag, Frozen Vegetables, Ground Meat, Frozen Entrees)
Melt, Soft & Warm Options	5 (Butter, Chocolate, Ice Cream, Cream Cheese, Syrup, Dessert Topping)
Defrost	6 (Ground Meat, Steaks/Chops, Boneless Poultry, Bone-in Poultry, Roast, Casserole or Soup)
Other Menus	3 (Beverage Reheat, Hot Water, Hot Cereal)
TECHNICAL FEATURES	
Supply Voltage, V/Hz	120V/ 60Hz
Rated Current, A	14.5 A
DIMENSIONS	
Cavity Dimension (WxDxH)	17-5/16" x 16-9/16" x 7-1/8"
Exterior Dimension (WxDxH)	23-7/8" x 23-3/8" x 16-5/16"
Carton Dimension (WxDxH)	29-1/4" x 27-7/8" x 21-1/2"
Net Weight / Gross Weight	74.0 lbs / 85.8 lbs
INSTRUCTIONS FOR USE	
Use & Care Manual / Installation Manual	English / French