



AGA TC5 and DC5 (Hotcupboard with Induction Cooktop)

THESE INSTRUCTIONS MUST BE READ IN CONJUNCTION WITH THE TOTAL CONTROL OR DUAL CONTROL RANGE INSTALLATION AND USERS GUIDE



Owners Manual comprising Users and Installation Guide

REMEMBER: when replacing a part on this appliance, use only spare parts that you can be assured conform to the safety and performance specification that we require. Do not use reconditioned or copy parts that have not been clearly authorized by AGA.

IMPORTANT : SAVE INSTRUCTIONS FOR FUTURE REFERENCE

IMPORTANT : CONSERVER CES INSTRUCTIONS POUR REFERENCE FUTURE

For use in USA/Canada

12/15 EINS 517244

CONTENTS

SECTION	PAGE
Product Safety	3
General Notes	3
Users Section	4
Introduction	4
Safety	4
Fire	4
Pans	5
How to use your Induction Cooktop	5
Induction Cooktop	5
Control Panel	5
Switching the Induction Cooktop ON	5
Setting the Power Level	5
Switching the Induction Cooktop OFF	6
Pan Detection	6
Residual Heat Indicator	6
Pause	6
Warming Function	6
Auto Cook	6
Minute Timer	7
Control Locking	7
Overheat Protection	7
Hutcupboard	8
Cleaning	9
Installation Guide	10
General Installation Requirements	10
Using Left Hand Side Flue Vent Option -	10
AGA Dual Control 5 Oven Gas Power Flue only	
Electrical Connection	10
Warranty Service	11
Wiring Diagram	11
AGA TC5/DC5 (Electric) - Appliance Dimensions	12
AGA DC5 Gas Power Flue - Appliance Dimensions	13

PRODUCT SAFETY

MEANING/DESCRIPTION	SYMBOL	SIGNIFICATION/DESCRIPTION
<p>WARNING/CAUTION</p> <p>An appropriate safety instruction should be followed or caution to a potential hazard exists.</p>		<p>AVERTISSEMENT</p> <p>Une consigne de sécurité appropriée doivent être suivies ou garde d'un danger potentiel exists.</p>
<p>DANGEROUS VOLTAGE</p> <p>To indicate hazards arising from dangerous voltages.</p>		<p>TENSION DANGEREUSE</p> <p>Pour indiquer les dangers résultant des tensions dangereuses.</p>
<p>PROTECTIVE EARTH (GROUND)</p> <p>To identify any terminal which is intended for connection to an external conductor for protection against electric shock in case of a fault, or the terminal of a protective earth (ground) electrode.</p>		<p>TERRE DE PROTECTION</p> <p>Pour marquer bornes destinées à être raccordées à un conducteur de protection extérieur contre les chocs électiques en cas de défaut d'isolement, ou pour marquer la borne de la terre de protection.</p>
<p>HEAVY</p> <p>This product is heavy and reference should be made to the safety instructions for provisions of lifting and moving.</p>		<p>LOURD</p> <p>Ce produit est lourd et doit être fait référence aux consignes de sécurité relatives aux dispositions de soulever et déplacer.</p>
<p>DISCONNECT MAINS SUPPLY</p> <p>Disconnect incoming supply before inspection or maintenance.</p>		<p>APPAREIL À LASER DE CLASSE 2</p> <p>Alimentation d'entrée Débrancher avant inspection ou d'entretien.</p>
<p>REFER TO MANUAL</p> <p>Refer to relevant instructions detailed within the product manual.</p>		<p>ATTENTION, SURFACE TRÈS CHAUDE</p> <p>Reportez-vous aux instructions applicables, indiquées dans le manuel du produit.</p>

GENERAL NOTES

Consumer Protection

As responsible manufacturers we take care to make sure that our products are designed and constructed to meet the required safety standard when properly installed and used.

PLEASE READ THE ACCOMPANYING WARRANTY

Any alterations that is not approved by AGA could invalidate the approval of the appliance, operation of the warranty and could also affect your statutory rights



CAUTION:
**THIS UNIT IS HEAVY, PROPER EQUIPMENT AND ADEQUATE
 MANPOWER MUST BE USED IN MOVING THE RANGE TO
 AVOID DAMAGE TO THE UNIT OR THE FLOOR**

Users Guide

Introduction

Thank you for choosing the AGA Hotcupboard with induction cooktop. The induction cooktop is an efficient way of cooking and will give you more control during the cooking process. The hotcupboard provides gentle heat, in the form of a slow cooking oven and warming oven.

Please read these instructions to ensure a full understanding of the controls and the precautions required prior to their use.

Safety

Please read the following points carefully.

- **Important information for pacemakers and insulin pump users.**
The functions of this induction cooktop complies with applicable standards for electromagnetic interference. If you are fitted with such a device and have concerns please consult your doctor for medical advice.
- This appliance is not intended for use by persons (including children under 8) with reduced physical, sensory and mental capabilities, or lack of experience and knowledge, unless they have had or been given supervision or instruction concerning its use by a person responsible for their safety and understand the hazards involved.
- Children shall not play with the appliance. Cleaning and user maintenance shall not be made by children without supervision.
- Do not use a cracked or broken cooktop. Should a crack appear and to avoid electric shock, disconnect the appliance from the electrical supply and arrange for its repair.
- Surfaces on and around the appliance may get hotter than expected and remain hot during and for a while after use, children should be kept away during this time.
- When the cooktop is in use keep items that use a magnetic storage medium, such as credit cards away.
- Metallic objects such as cutlery, should not be placed or stored on the induction cooktop as they may get hot. Cutlery, utensils and unused pans should be stored elsewhere.
- Do not allow saucepan handles to overhang the cooktop.
- Do not slide cooking pans over the cooktop.
- After use, turn the induction cooktop off, do not rely on the pan sensor.
- Do not use the cooktop as a cutting board.
- Do not use the appliance to dry clothes and other combustible materials.
- Do not obstruct appliance vents by placing towels, clothes etc. on the hand rail.
- Do not use steam cleaners on your appliance.

Fire!

- To avoid fire. Never leave a pan containing oil unattended. Always heat oil slowly and watch as it heats. To prevent spillage do not fill a pan more than a third of its capacity, this will prevent spill over when adding food.
- **DO NOT** use water on a fat/oil fire. **NEVER** move the pan. Turn off the appliance at the wall switch and carefully smother the flame with a lid, fire blanket or use an approved dry extinguisher.

Pans

It is important to use pans that are specifically recommended for induction cooking. Generally stainless steel, special pans with stainless steel bases, enamelled steel, or cast iron pans with flat enamelled bases are suitable. It should be noted that some grades of stainless steel pans may not function or may be slow to heat.

All copper and all aluminium constructed pans or ceramic pans, will not work on an induction cooktop. If you are unsure of a pan, try a quick test using a magnet on the pan base (See Fig. 1). A strong attraction between magnet and pan, will normally indicate a suitable pan. Weak or no attraction usually indicates a pan that is not suitable. Do not forget to remove the magnet before using the pan on the cooktop.

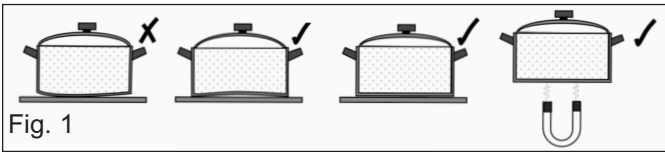

Use pans that are the same size or slightly larger than the marked area. Smaller pans will take longer to heat. Using a pan with a lid will help pan contents boil more quickly.

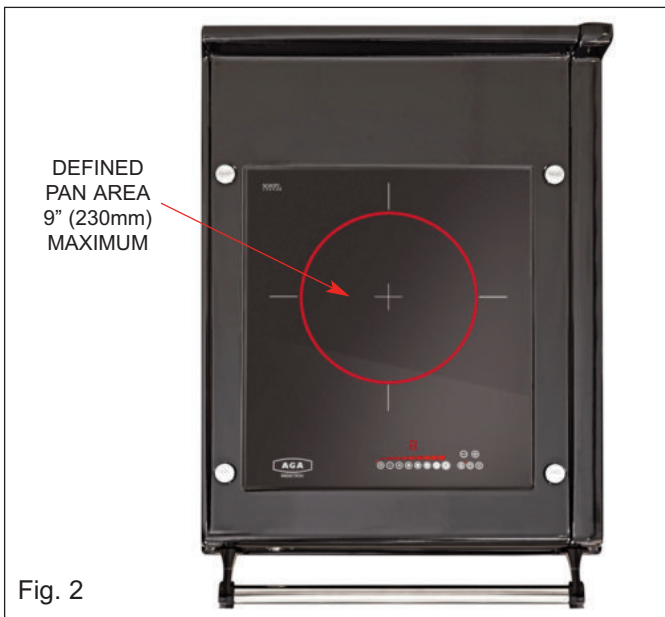

Ideally pans should have near flat bottoms to maximise induction efficiency.

Most types of pans will generate a faint audible sound during the cooking process and this is perfectly normal. The level of sound will vary depending on the type and style of pan used.

AGA accessories can be viewed at your local AGA dealer or online at www.aga-ranges.com

How to operate your Induction Cooktop

Place an appropriate pan containing food to be heated, onto the induction cooktop.

Touch the power on pad , touch the induction on pad .

Set power level by sliding your finger along the power level pads to the required setting.

To simmer, slide your finger down the power level pads for a lower setting.

Turn the cooktop off after pan contents are heated, by touching the power off pad .











Remove the pan from the cooktop carefully, as it will be hot.

Induction Cooktop

The induction cooktop works independent of the AGA hotcupboard. It is not necessary for the hotcupboard control switch to be on when the induction cooktop is in use.

All of the induction cooktop functions are accessed via the touch pads located on the ceramic surface.

Display Indicators

 Auto Cook	 Warming settings
 Pan detection	 Timer set
 Residual heat	 Pause set
 Lock set	 Power levels
 Boost	 Prolonged pad contact

Control Panel - See Fig. 3

Always use positive finger contact on the touch pads to ensure a good control response (by gently touching and not pressing the pad).

Touch pads may not respond if the induction cooktop control area is wet. Touch pad area should be dried prior to use.

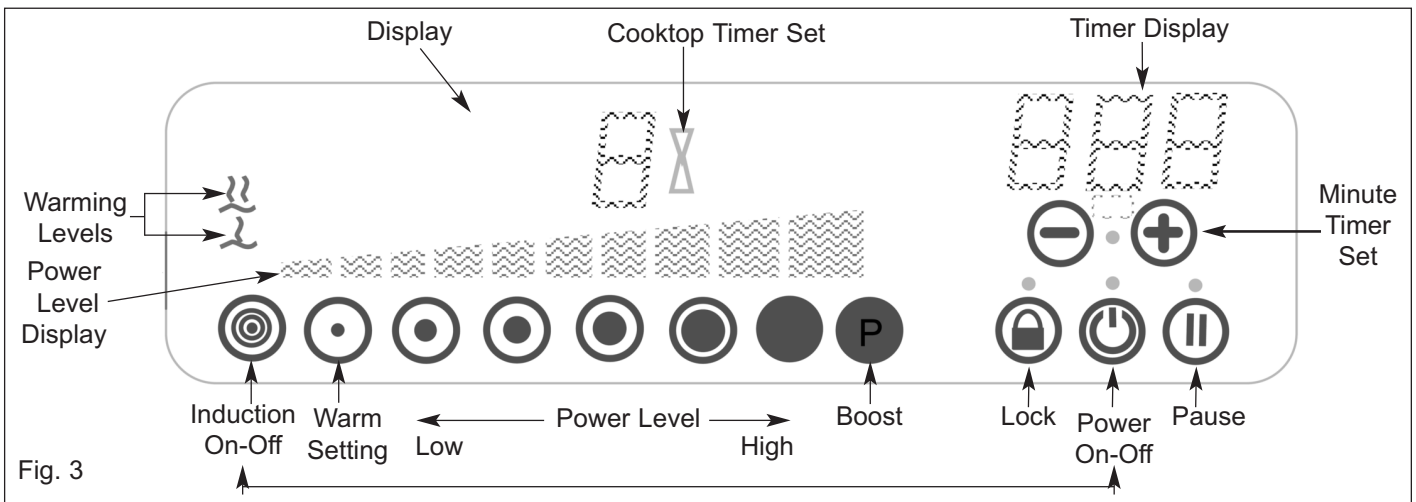

Switching the Induction Cooktop ON

Using the induction cooktop requires three steps.

1. Touch the power on - off pad
2. Touch the induction on - off pad
3. Set the required power level

If power level is not set within 20 seconds the unit will automatically switch off.

Setting the Power Level

This induction cooktop offers 10 levels of power the first 9 power levels can be selected by touching an individual power level pad or by sliding your finger along the pads. A visual indicator will illuminate as both a numerical as a level display with a representing high.

The 10th power level is achieved using the boost function. To set the boost function, touch boost pad the display will indicate . The boost function will run for 10 minutes maximum before reverting back to setting .

Switching the Induction Cooktop OFF

After use the cooktop should be turned off by touching the power touch pad .

Pan Detection

When the power is on and a power level is selected, the pan detection will be automatic whenever the pan is placed within or removed from the cooking zone on the cooktop. (See Fig. 2 for defined pan area and Fig. 4 for pan location).

If there is no pan placed on the cooking surface the display will flash .

Always switch off by touching the power pad when the cooktop is not in use.



Residual Heat Indicator

The cooktop surface will get hot when in use, this is due to heat being conducted from the cooking pan. The cooktop surface will also remain hot for a while after use.

After the cooking period the cooktop hot indicator will be displayed and for a short period of time after power off.

Pause





To interrupt the cooking period, touch the pause touch pad , cooking will stop and will be displayed.



To recommence cooking, touch pause pad and then slide your finger the full length of the power level pads, through to the original power level will be automatically set.

Pause remains active for 10 minutes only, after 10 minutes the cooktop will switch off.

Warming Function

The warming function will keep cooked food warm for a set period of time.



Touch the power on - off pad . Touch the induction on - off pad  and touch the first power level pad  to select warming level one, the warming indicator  and  will be displayed.

To select the second and higher warming level, touch and hold the first power level pad . The warming indicator  and  will be displayed.

Auto Cook

The Auto Cook feature allows the pan contents to be brought up to a high temperature rapidly, before reverting back to the set power level.

To set Auto Cook

Touch power on pad  and then touch induction on pad .





Touch required power level pad for 5 seconds. The symbol  along with the set level, will flash in the display.



Turn off the cooktop by touching the off pad  after cooking is complete.

Minute Timer







The induction cooktop has two individual tim:

Kitchen Timer, for general kitchen timing requirements, for example, timing food cooked in an oven.

Touch power pad  and then ... pads together,  will be displayed.



A time can now be set using  or  touch pads. The count down will commence after a few seconds. If an instant countdown is required touch the power pad .





After the set time has elapsed the audible alarm can be cancelled by touching the power off pad .

To modify or cancel a previously set time, touch power pad  (on) and then ... pads together.... Release and then touch either the  or  pad to adjust the time setting, or set to zero time.





Minute Minder, for timing the duration of the induction cooking process.

The timer functions do not start or stop a cooking process.

Touch power pad  followed by induction on pad , set the required power level .

Touch pads ... together  will be displayed, use  and  pads to set time. The count down will commence after a few seconds.

After set time has elapsed the audible alarm can be cancelled by touching the power off pad .

To modify a previously set time, touch ... pads together and adjust using  and  pads.

The timer with the shortest time period remaining will show in the display.

Control Locking

There are two control locking features:



1. **Temporary Lock**, this feature will lock the controls for the duration of a cooking process to prevent accidental adjustment of the controls.

Touch power button  followed by induction on pad .

Set to required power level . Touch lock key .

Power levels only, are locked to prevent adjustment during a cooking period.



To unlock, touch the lock pad  to enable power level adjustment, or power pad  to turn the cooktop off.



To remove the feature, after use touch power on pad  and then lock pad .



2. **Fixed Lock**, will lock the controls, even when the cooktop is powered off, this feature is to prevent accidental and unsupervised cooktop use and will require manual intervention before use, or deactivation of the feature.

Power off pads  and  will always function.

Touch pads can be locked to prevent unsupervised control function, even after the cooktop has been powered off. Manual intervention or a deactivation sequence will be required to return the cooktop to normal operation.





To activate the fixed lock. Touch power pad , followed by induction on pad .

Touch lock and pause pads together  , release and then touch lock pad . -L- will be displayed.

Manual intervention will be required to release the control functions for use. This is done by touching lock and pause pads together   followed by induction on  pad.

The induction cooktop control function will now be normal.

When the cooktop is switched off the Fixed Lock will still be active.

To deactivate the Fixed Lock. Touch power pad , touch lock and pause pads together  , release and then immediately touch the pause  pad.

If deactivation fails wait 20 seconds before retrying or unplug the appliance.

Overheat Protection

Power levels will be automatically reduced if excessive high temperatures are monitored below the cooking zone. If high temperatures are detected it will not be possible to adjust the power level to a higher level than shown in the visual displays.

Should a pan be allowed to boil dry the overheat protection system will turn the induction cooktop off.

Hotcupboard

Simmering Oven plus Warming Oven

These ovens are not cast iron on the interior. They are heated by a single element at the rear of the oven cavity. It is operated by a single push ON-OFF button located on the left hand side of the hotcupboard top plate and can be turned ON and OFF when required. (See Fig. 5).

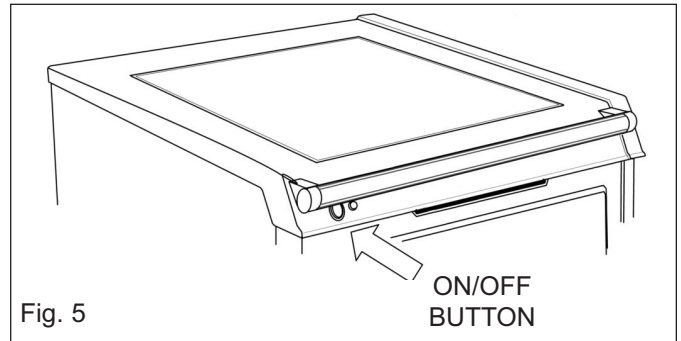

Fig. 5

Simmering Oven

This oven delivers a gentler convected heat making it better suited for longer cooking times, especially for overnight cooking, for example rich fruit cakes and celebration cakes. The cooking of meringues may also be better suited for this oven.

NOTE: These ovens vent into the room, mechanical venting to the outside is not available.

Points to remember when using the Simmering Oven:

- Pre-heat the oven for 30 minutes before starting to cook.
- Bring casseroles, soups etc to the boil on the hotplate and start meat in the roasting oven, before placing in the slow cook oven.
- Make sure that casseroles have sufficient liquid, particularly when cooking over a long period.
- Use lids on casseroles or foil to cover food whilst it is cooking to retain moisture.
- Make sure all dishes will fit into the oven before preparing food.
- Make sure that meat and poultry is piping hot before eating and reaches 75°C internal temperature.
- Always thaw frozen food completely before cooking.

You can also produce crisp white meringues in the slow cooking oven.

Timings for simmering oven will depend upon the temperature, quantity and type of dish you are cooking, as a guide for casseroles, a minimum of 2 hours cooking time is recommended.

Keep an eye on the food until you are familiar with the oven.

Cleaning

Induction Cooktop

Make sure all the surfaces have cooled prior to cleaning the cooktop and front plate.

The easiest way to clean the AGA induction cooktop and front plate is to mop up spills as soon as they happen. It maybe useful to keep a damp cloth handy to do this. The ceramic surface should then be cleaned with a proprietary cleaner.

If milk or fruit juice or anything containing acid, is spilt on the cooker, wipe it up immediately.

Also, clean off any condensation streaks on the front plate around the oven doors or the vitreous enamel maybe permanently discoloured.

All that is usually needed to keep the vitreous enamel surfaces of the cooker bright and clean is a daily rub over with a damp soapy cloth followed immediately with a clean, dry cloth to avoid streaks.

Ensure the lower vent is cleaned on a regular basis, and free from obstruction, to maintain sufficient air flow through the appliance. (The louvered plinth fascia can be easily removed for cleaning).

Hotcupboard Ovens

Oven Door Linings

The best way to keep the linings clean is to wipe them over after cooking (be careful with a hot cooker), so that splashes do not get baked on.

Clean the linings when they are cool and the cooker is off. The linings can be cleaned with hot soapy water and /or a cream cleanser. To deep clean the linings, place a towel on the work surface and carefully lift off the oven door (doors are heavy). Place it enamel side down on the towel padding. Clean with a soapy impregnated pad to remove stubborn marks. Do not immerse the doors in water as they are packed with insulating material which will be damaged by excessive moisture. Dry off before carefully replacing on their hinges.

Do not put oven doors in a dishwasher.

Installation Guide

Please refer to the Total Control or Dual Control installation guide for product dimensions following the Hotcupboard instructions.

General Installation Requirements

The installation of the range must be in accordance with the relevant requirements of the local Wiring and Building Regulations. It should be in accordance also with any relevant requirements of the local or state codes.

In your own interest and that of safety to comply with the law, all appliances should be installed by an authorized AGA distributor in accordance with the relevant regulations.

Using Left Hand Side Flue Vent Option - AGA Dual Control 5 Oven Gas Power Flue

When installing a **AGA Dual Control 5 Oven Gas Power Flue** where the cooker flue vent pipe exits to the left, it will be necessary to use the off set flue pipe adaptor (supplied with the installation kit). The adaptor must be positioned at the cooker left hand flue exit to allow the flue tube to pass behind the hotcupboard. (See Figs. 6 and 7).

Always fit the offset elbow in a position that will not create a water/grease trap.

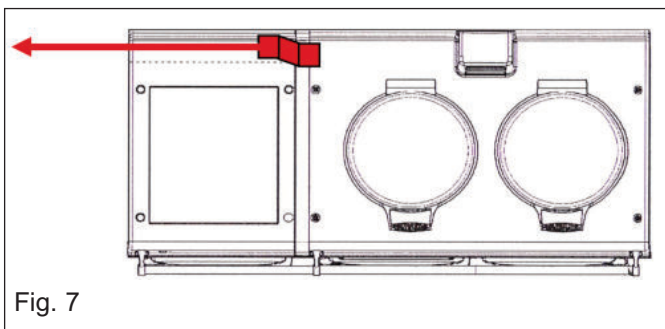
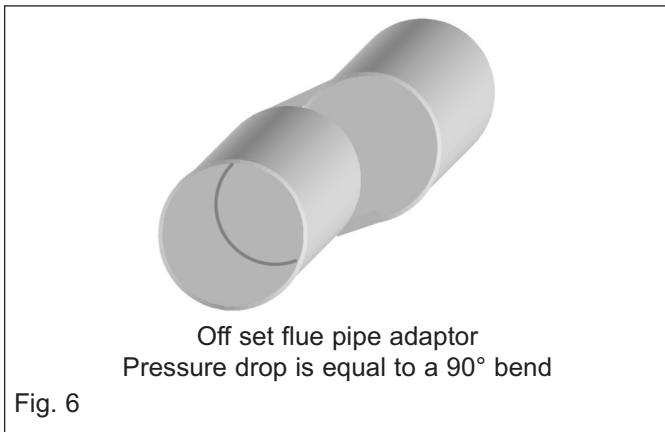

Electrical Connection



Use these instructions when making the electrical connection.



Electrical grounding is required on this appliance.

DO NOT connect to the electrical supply until the appliance is permanently grounded.

This appliance must be connected to a ground metallic permanent supply or wire lead on the appliance.

Failure to follow these instructions could result in death or serious injury.

This appliance must be supplied with a 240V 60Hz power supply and connected to a properly grounded branch circuit protected by an appropriate circuit breaker.

At 240 Volts the appliance has a maximum load of 12.5 amps.

The rating plate can be found on a pull out plate located at the lower front of the appliance. Electrical hook-up must be done by a licensed electrician. This appliance must be installed according to regional codes, or in the absence of regional codes, the National Electrical Code.

The power cord on the appliance is fitted with a standard 3 conductor NEMA type **6-20 P** plug, and should be plugged directly into a matching receptacle (matching receptacle 6-20R) Do not cut or remove the grounding prong from this plug.

An electrical socket (receptacle) must be provided within 5 feet of the left hand side of the appliance and easily accessible for the user to disconnect. Do not position the socket over the appliance. Do not use an extension cord with this appliance.

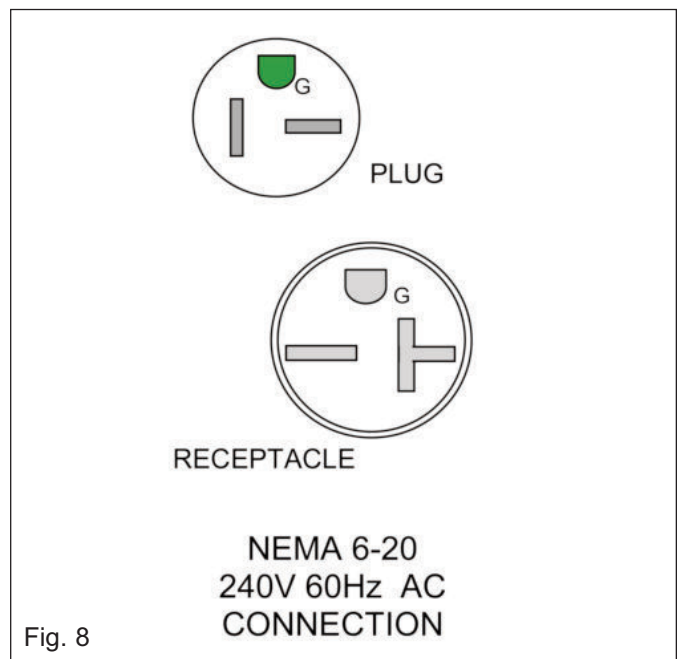

Service

Please refer to main guide for service detail.

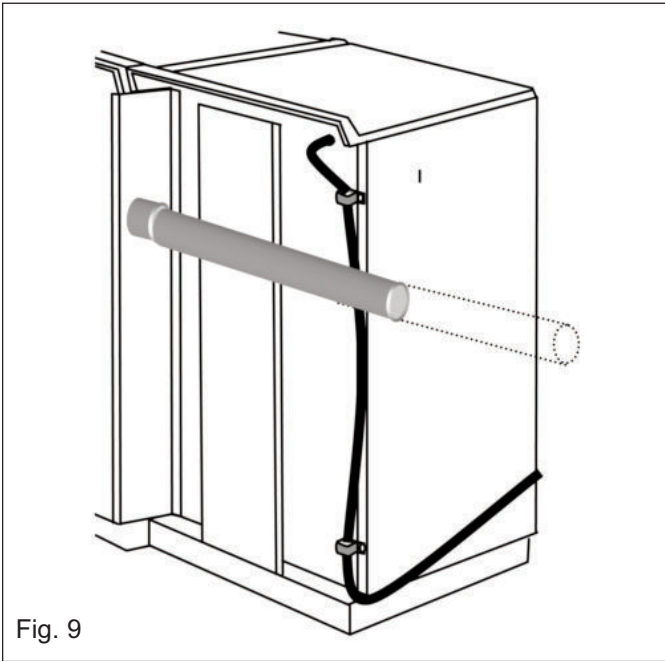

Fig. 9

Do not fuse the grounding circuit as this could result in an electric shock.

Failure to follow these instructions could result in death or serious injury.

Wiring Diagram

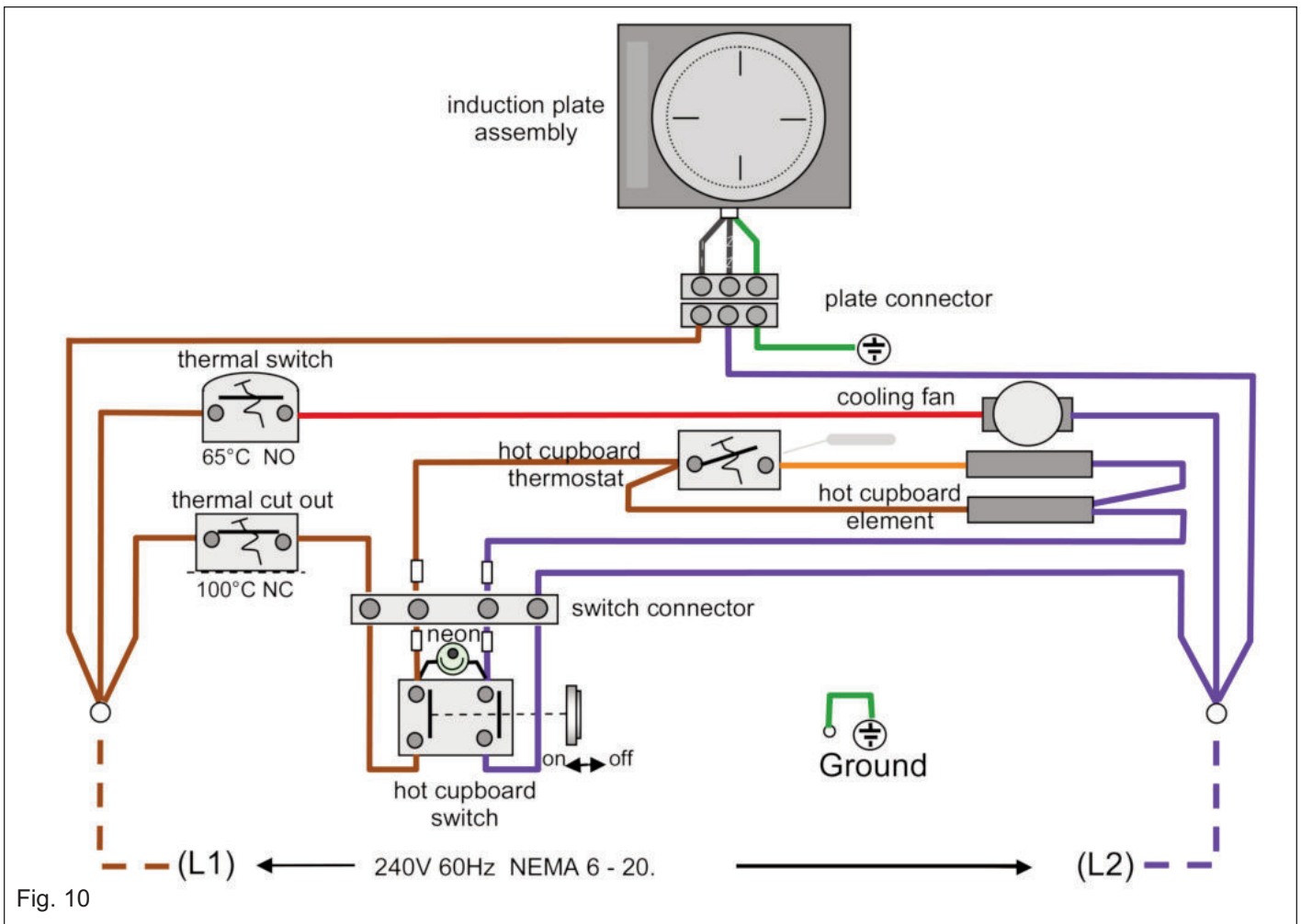
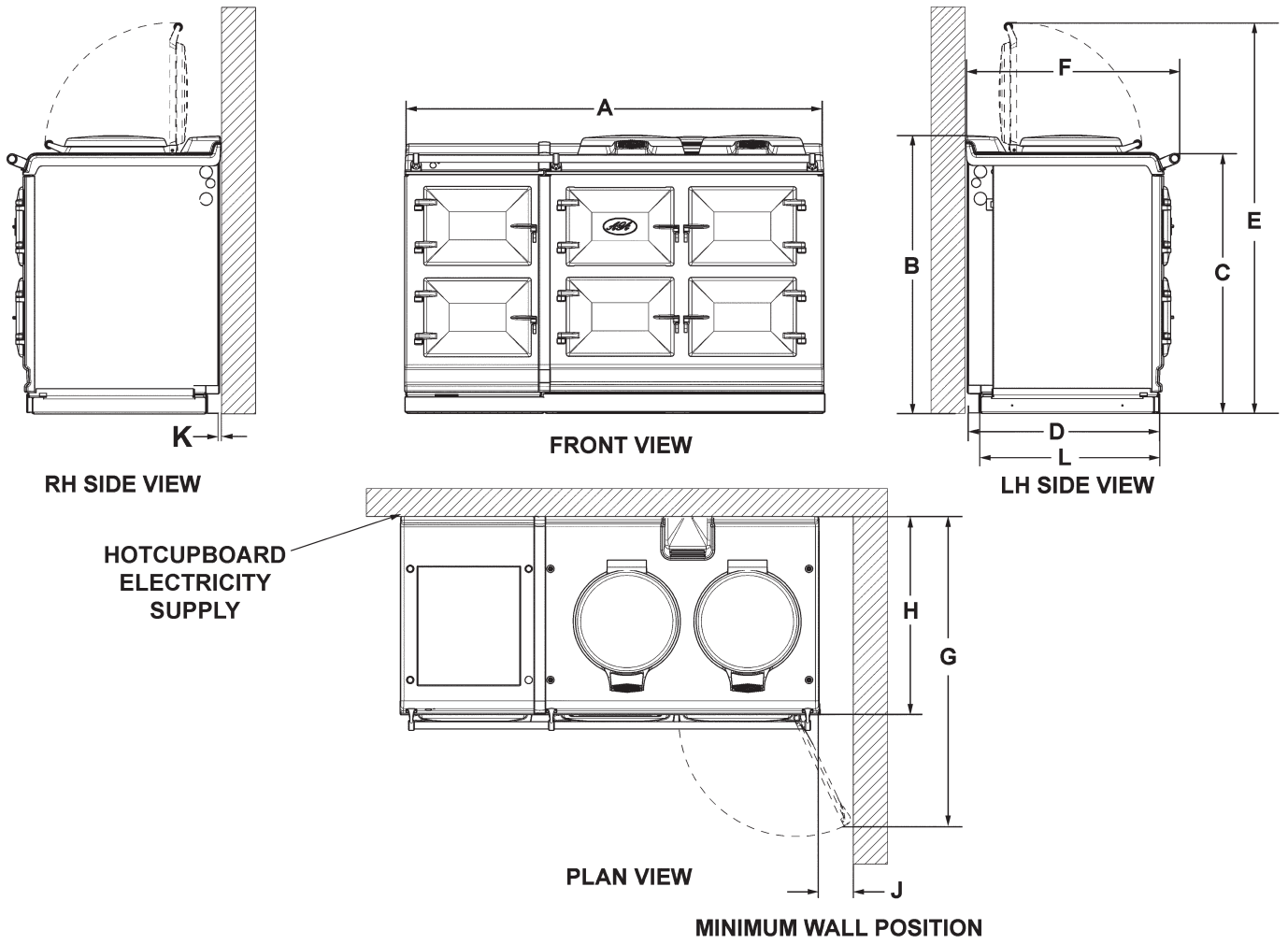

Fig. 10

AGA TC5/DC5 - RANGE DIMENSIONS



	A	B	C	D	E	F	G	H	J	K	L
mm	1478	951	913	680	1388	760	1145	698	116	10	634
ins	58 1/4	37 1/2	36	26 3/4	54 5/8	29 7/8	45 1/8	27 1/2	4 9/16	3/8	25

Fig. 11

DESN 516561

AGA DC5 GAS POWER FLUE - RANGE DIMENSIONS

OVERHEAD CUPBOARD

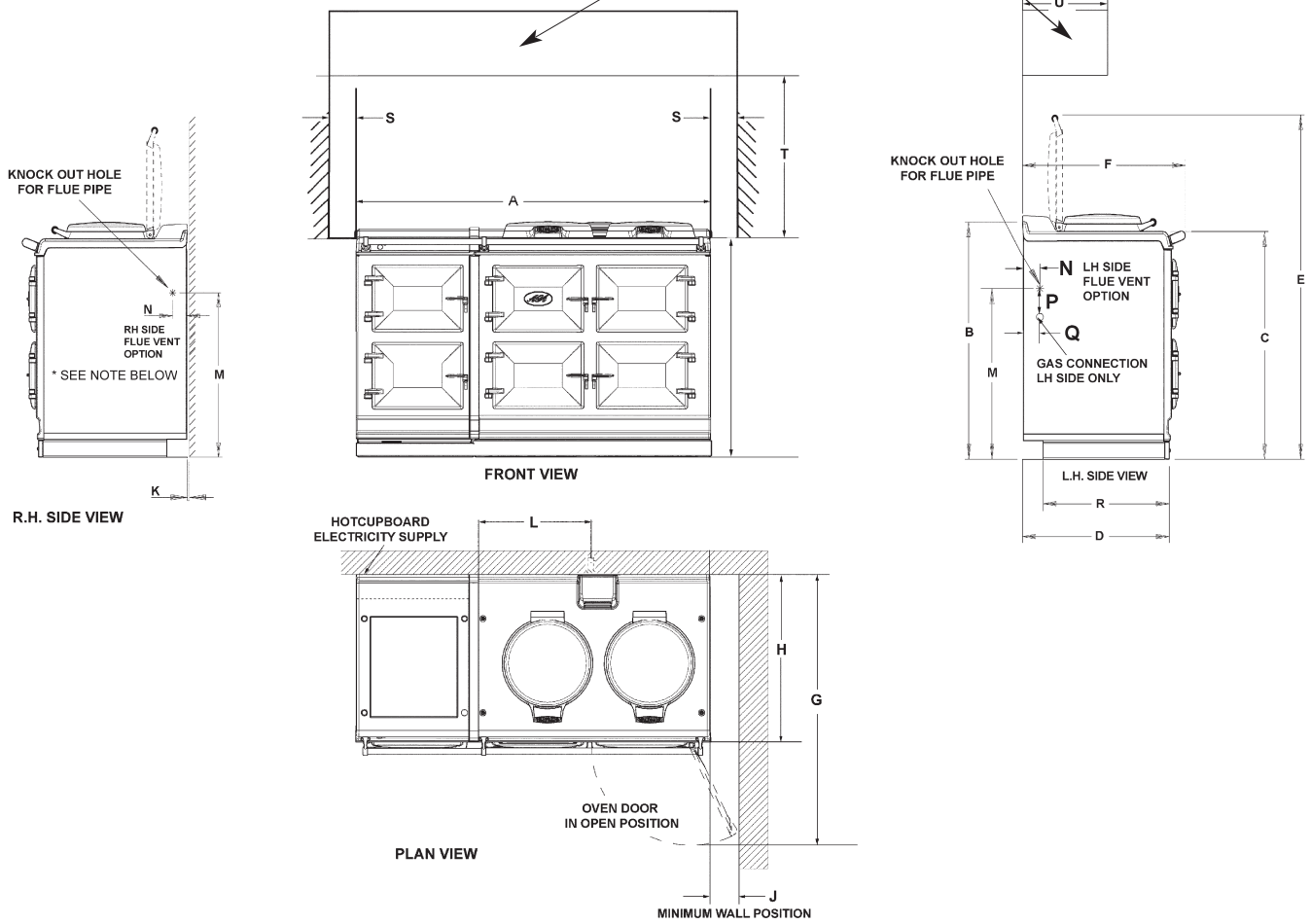

	A	B	C	D	E	F	G	H	J	K	L	M	N	P	Q	R	S	T	U
mm	1478	951	913	680	1388	760	1145	698	116	10	565	689	43	118	55	634	75	760	330
inch	58 1/4	37 1/2	36	26 3/4	54 5/8	29 7/8	45 1/8	27 1/2	4 9/16	3/8	22 1/4	27 1/8	1 3/4	4 5/8	2 1/8	25	3	30	13

Fig. 12

DESN 516848 A

**For further advice or information contact
your local AGA Specialist**

With AGA Marvel's policy of continuous product improvement, the Company reserves the right to change specifications and make modifications to the appliance described and illustrated at any time.



Supplied by

AGA Marvel
1260 E. Van Deirse St.
Greenville, MI 48838

Business (616) 754-5601
Fax (616) 754-9690
Toll Free Telephone 800-223-3900

www.agamarvel.com