

INSTRUCTION MANUAL
BLENDER

EN

MANUEL D'UTILISATION
MÉLANGEUR

FR

MANUAL DE USO
LICUADORA

ES



Dear Customer,

Thank you for purchasing a Smeg 50's Style blender.

By choosing one of our products, you have selected an appliance which combines iconic style with innovative technical design and attention to detail.

This appliance coordinates perfectly with other Smeg products, or works equally great as a standalone statement piece in your kitchen.

We hope you enjoy using your new appliance!

For any further information please visit www.smegusa.com.



Model BLF01
Blender

Contents

1 Instructions	7
1.1 Introduction	7
1.2 This user manual	7
1.3 Intended use	7
1.4 Manufacturer liability	8
1.5 Identification plate	8
1.6 Disposal	8
2 Description	9
2.1 Product description	9
2.2 Description of parts	10
3 Use	13
3.1 Before first use	14
3.2 How to remove the blade assembly	14
3.3 Using the blender	16
3.4 Functions	19
3.5 Speed setting suggestions	20
4 Cleaning and Care	22
4.1 Instructions	22
4.2 Maintenance	22
4.3 Cleaning the motor base	22
4.4 Cleaning the blender jar and blade assembly	22
4.5 Using the Self-clean option	22
4.6 Cleaning other blender parts	22
4.7 What to do if...	23
5 Recipes	25

Important Safeguards

WARNING: If the instructions contained in this manual are not followed precisely, fire or explosion may result causing property damage, personal injury or death.



READ AND SAVE THESE INSTRUCTIONS - Your safety and the safety of others are very important.

We have provided many important safety messages throughout this manual and on the appliance.

Read all the instructions before using the appliance and always obey all safety messages.



Important Safeguards



RECOGNIZE SAFETY INFORMATION

This is a safety alert symbol. This symbol alerts you to potential hazards that can result in severe personal injury or death.

UNDERSTAND SIGNAL WORDS

A signal word - DANGER, WARNING or CAUTION - is used with the safety alert symbol. DANGER denotes the most serious hazards. It means you could be killed or seriously injured if you do not immediately follow the instructions. WARNING means you could be killed or seriously injured if the instructions are not followed. CAUTION indicates a potentially hazardous situation, which, if not avoided, could result in minor to moderate injury.

WARNING



- This appliance is intended for use in the home only.
- Use this appliance only for its intended purpose. The manufacturer cannot be held liable for damage caused by improper use of this appliance.
- This appliance complies with current safety regulations. Improper use of this appliance can result in personal injury and material damage.
- Read all the instructions before installing or using the appliance for the first time.
- Keep these operating instructions in a safe place and pass them on to any future user.

The safety messages will inform you of potential hazards, on how to avoid the risk of injury and what can occur if the instructions are not followed.

IMPORTANT: Observe all codes and ordinances in force.

WARNING: For your safety, the instructions contained in this manual must be followed to minimize the risk of fire or explosion and to prevent property damage, personal injury or death.

Do not store or use gasoline or other flammable vapors, liquids or materials near this or any other appliance.



NOTE: This appliance is NOT designed for installation in manufactured (mobile) homes or in recreational vehicles (RVs).

DO NOT install this appliance outdoors.

Important Safeguards



WARNING



To reduce the risk of fire, electrical shock, personal injury, or damage when using the appliance, follow basic safety precautions, including the following:

When using electrical appliances, basic safety precautions should always be followed including the following:

- Read all instructions.
- To protect against risk of electrical shock do not put the motor unit in water or other liquid.
- Close supervision is necessary when any appliance is used by or near children.
- Unplug from outlet when not in use, before putting on or taking off parts, and before cleaning.
- Avoid touching moving parts.
- Do not operate any appliance with a damaged cord or plug or after the appliance malfunctions, is dropped or damaged in any manner. Return appliance to the nearest authorized service center for examination, repair, or electrical or mechanical adjustment.
- For household use only. Do not use outdoors.
- Do not let cord hang over edge of table or counter.
- Switch off the appliance immediately after use.
- Do not leave the appliance unattended while it is operating.
- If the power supply cord is damaged, it must be replaced by a service representative to avoid a hazard.
- The cable is short to prevent accidents. Do not use an extension cord.
- In the event of a fault, repairs should only be carried out by a qualified technician.
- Do not modify the appliance.
- Never try to put out a fire or flames with water: turn off the appliance and remove the plug from the socket and smother the flames with a fire blanket or other appropriate cover.



Important Safeguards

For this appliance

- Avoid touching moving parts. Keep hands, hair, clothing and utensils away from the blades during operation, to prevent personal injury and/or damage to the appliance.
- Remove blades from the jar before washing.
- The use of attachments, including canning jars, not recommended by the manufacturer may cause a risk of injury to persons.
- Blades are sharp. Handle carefully.
- To reduce the risk of injury, never place the blade assembly on the base without properly attaching the jar.
- Do not blend hot liquids.
- Always operate the blender with the lid in place.
- The flashing light indicates that the appliance is ready to operate. Avoid any contact with blades or moving parts.
- Care shall be taken when handling and emptying the jar and during cleaning.
- Always unplug the blender if it is left unattended and before assembly, disassembly or cleaning. Unplug the blender when it is not being used, before cleaning and if you notice any fault. Let the appliance cool down before cleaning.
- Check that the lid is correctly closed before turning on the blender. Do not overfill the blender (max. 1.5 liters).
- Do not use the blender with parts or accessories of other manufacturers.
- Only use original spare parts. The use of spare parts not approved by the manufacturer could lead to fires, electric shocks or personal injury.
- Only place the blender on level and dry surfaces.
- Do not run the blender empty.
- Do not use the blender as a storage compartment. Keep it empty before and after use.
- Keep hands and utensils out of the jar while blending to reduce the risk of severe injury to persons or damage to the blender. A spatula may be used but must be used only when the blender is not running.
- Do not use harsh detergents or sharp objects to wash or remove residues from the blender jar.

SAVE THESE INSTRUCTIONS

Important Safeguards



EN

1 Instructions

1.1 Introduction

Key information for the user:

Instructions



General information on this user manual, safety and final disposal.

Description



Appliance description.

Use



Information on using the appliance

Cleaning and care



Information for proper cleaning and maintenance of the appliance.

Recipes



List of recipes



Safety instructions



Information



Advice

1.2 This user manual

This user manual is an integral part of the appliance and must therefore be kept in its entirety and within the user's reach for the whole working life of the appliance.

1.3 Intended use

- Use the appliance indoors only.
- This appliance has been designed specifically for domestic use. It must only be used for blending, emulsifying ingredients and crushing ice. Do not use the appliance for anything other than its intended use.
- This appliance is intended for use in a home environment. Every other use is considered improper. It also can be used in:
 - staff kitchen areas in shops, offices and other working environments;
 - farm houses;
 - by guests in hotels, motels and other residential type environments;
 - bed-and-breakfast-type environments.
- The appliance is not designed to operate with external timers or with remote-control systems.
- This appliance may not be used by people of reduced physical or mental capacity, or without sufficient experience and knowledge (including children), unless they are supervised or instructed by adults who are responsible for their safety.
- Children must never play with the appliance. Keep the appliance out of children's reach.



Important Safeguards

1.4 Manufacturer liability

The manufacturer declines all liability for damage to persons or property caused by:

- Using the appliance other than as intended;
- Not having read the user manual;
- Tampering with any part of the appliance;
- Using non-original spare parts;
- Not following the safety instructions.

1.5 Identification plate

The identification plate bears the technical data, serial number and brand name of the appliance. Do not remove the identification plate for any reason.

1.6 Disposal



Power voltage
Danger of electrocution

- Turn off the appliance.
- Unplug the appliance from the wall outlet.
- **Old appliances do not belong in household waste!** To comply with current legislation, old appliances, having reached the end of their useful lives, should be taken to a disposal facility where they can be sorted. In this way, any valuable material contained in the old appliances can be recycled and the environment protected. Local authorities or their waste disposal operators can provide further information.

The appliance is packed in non-polluting and recyclable materials.

- Dispose of the packing materials at an appropriate disposal facility.



Plastic packaging
Danger of suffocation

- Do not leave the packaging or any part of it unattended.
- Do not let children play with the plastic bags.



2 Description

2.1 Product description

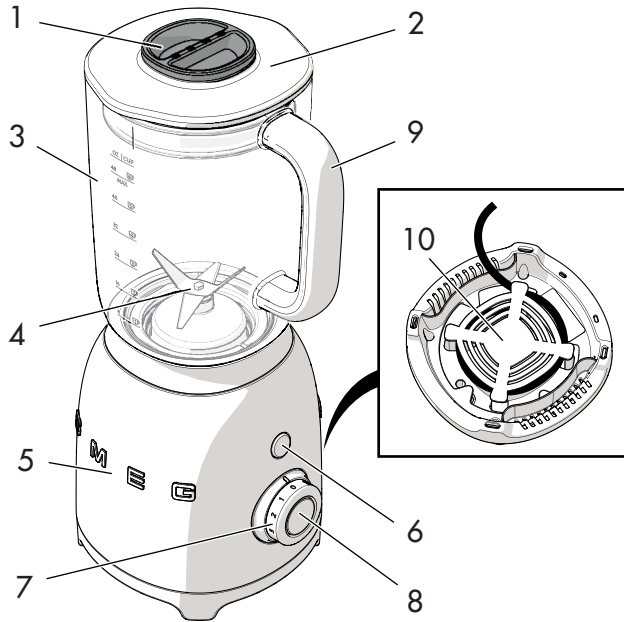

Model BLF01 - Blender

- 1 Measuring cup
- 2 Lid with pouring hole
- 3 1.5 liter (6 cups) Tritan™ BPA-Free jar
- 4 Detachable blade assembly
- 5 Motor base
- 6 Pulse button
- 7 Control knob
- 8 START/STOP button
- 9 Handle
- 10 Built-in cord wrap



Description

2.2 Description of parts

Measuring cup (1)

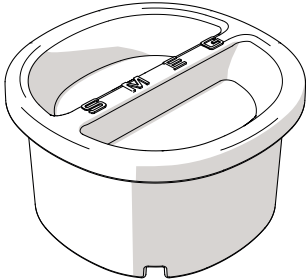

Convenient measuring cup. It can be used for measuring ingredients and as a device to unscrew the blade assembly from the base of the jar. See "3.2 How to remove the blade assembly".

1.5 liter (6 cups) Tritan™ BPA-Free jar (3)

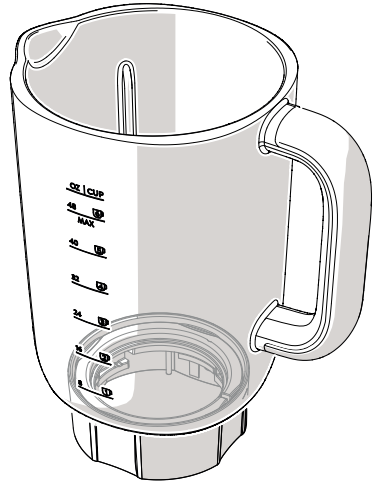

The large-capacity jar is made of Tritan™, which is a safer, lighter and easier to handle material than glass. Tritan™ is also resistant to impacts, scratches and heat.

The jar features a handy lip and is marked in both liters and cups.

It has a capacity that ranges from a minimum of 0.25 l (1 cup) to a maximum of 1.5 liters (6 cups).

Lid with pouring hole (2)

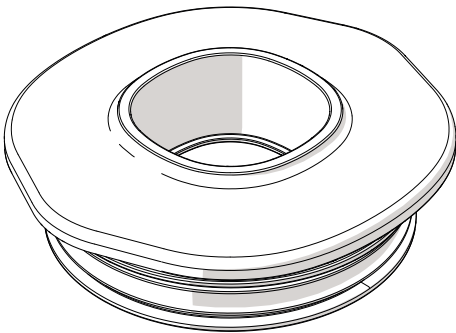

The lid has a seal that closes the blender jar tightly. It has a pouring hole in the centre to make adding ingredients easier during blender operation.



Detachable blade assembly (4)

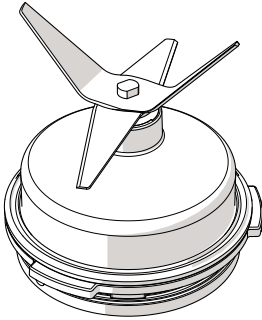

Stainless steel detachable blades to crush ice cubes and prepare delicious smoothies, milkshakes, cocktails, etc.

It can be unscrewed from the base of the jar to be cleaned.



Sharp blades

Danger of cuts

- Never touch the blades with your hands.
- Remove the blade assembly only using the measuring cup, as indicated in section "3.2 How to remove the blade assembly".



The accessories intended to come into contact with food are made of materials that comply with the provisions of current legislation.

Motor base (5)

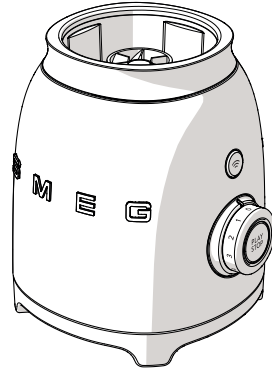

The base houses a powerful 600-watt motor.



To avoid damage to the blender, the appliance is equipped with a **safety lock system** which shuts off its operation when the jar is removed. It also features a **motor safety cut-out** which trips if the motor is overloaded.



Description

Pulse button (6)

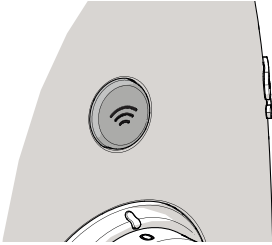

Press this button to get the maximum blending speed. Perfect for the most demanding tasks. It can be used for a maximum of 2 seconds at a time.

START/STOP button (8)

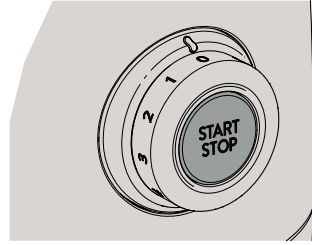

Press this button to start/stop blender operation.

Control knob (7)

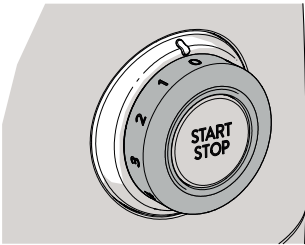

The control knob allows you to select one of the four speeds available from 1 to 4. The control knob also features 2 pre-set programs: smoothie and ice crush. See "3.5 Speed setting suggestions" for further information on which speed to use.



3 Use



Electrical Shock Hazard

- Plug into a grounded 3-prong outlet.
- Do not remove the ground prong.
- Do not use an adapter.
- Do not use an extension cord.
- Failure to follow these instructions can result in death, fire, or electrical shock.

Volts: 120 Volts AC only.

Hertz: 60 Hz



Your blender has a 3-prong grounded plug. To reduce the risk of electrical shock, this plug will fit into an outlet only one way. If the plug does not fit in the outlet, contact a qualified electrician. Do not modify the plug in any way.

- Do not use an extension cord. If the power supply cord is too short, have a qualified electrician or service technician install an outlet near the appliance.
- A short power supply cord (or detachable power supply cord) should be used to reduce the risk resulting from becoming entangled in or tripping over a longer cord.
- Longer detachable power supply cords or extension cords are available and may be used if care is taken when using them.

If a longer detachable power supply cord or extension cord is used:

- The marked electrical rating of the power supply cord or extension cord should be at least as great as the electrical rating of the appliance.
- The cord should be arranged so that it will not hang over the countertop or tabletop where it can be pulled on by children or tripped over unintentionally.
- If the appliance is of the grounded type, the extension cord should be a grounded 3-prong type cord.



Use

3.1 Before first use

1. Remove all stickers and labels from the blender and clean the motor base with a damp cloth.
2. Remove the blender jar.
3. Remove the blade assembly (see "3.2 How to remove the blade assembly").
4. Wash and dry thoroughly (see "4.4 Cleaning the blender jar and blade assembly").



Danger of sudden start-up

- Make sure the blender is unplugged before inserting or removing the blade assembly.

3.2 How to remove the blade assembly

1. Take hold of the handle (1) and lift the blender jar.



2. Remove the lid (2) from the blender jar and the measuring cup (3) from the lid.





3. Turn the jar upside down and place it on a flat surface. Insert the open end of the measuring cup (3) into the base of the blade assembly.

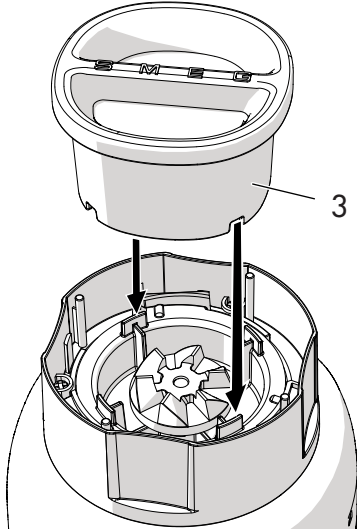

4. Unscrew the blade assembly (4) from the jar body, turning the measuring cup counterclockwise. Manually remove the blade assembly (4) from the jar body.

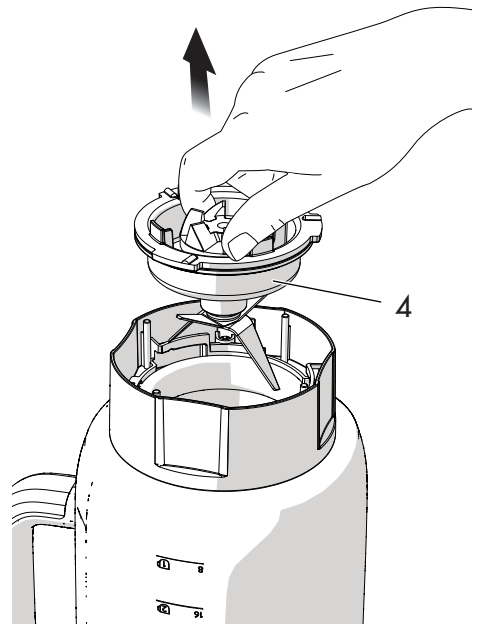
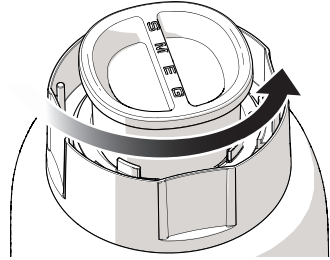



Use

5. Wash the jar, measuring cup, and blade assembly in warm soapy water. The jar and the measuring cup may also be washed in the dishwasher. Dry thoroughly and replace the blade assembly into the jar body following in the reverse order the instructions given previously. Make sure to insert the blade assembly until it locks into place.

3.3 Using the blender

1. Insert the blender jar onto the motor base.



2. Add the ingredients into the jar, being careful not to exceed the maximum capacity (1.5 l - 6 cups).

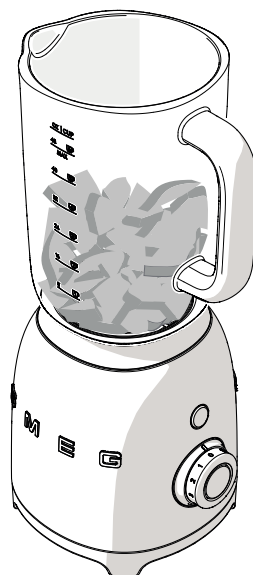



3. Position the lid with the measuring cup fitted onto the blender jar. Ensure the lid is firmly screwed on.



4. Plug the blender into a power socket. The red LED will flash to indicate the power is on. Select the desired speed or a pre-set program using the control knob or press the **PULSE** button to operate the blender manually.

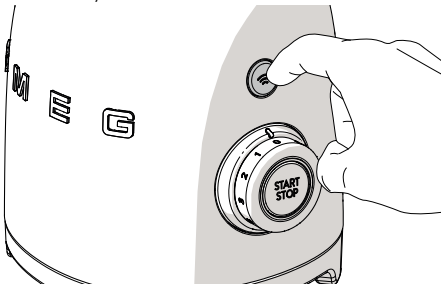

The **PULSE** button can be used alone or in combination with speeds 1 to 3 to reach the maximum speed.

5. Press the **START** button to start blending. See the table "3.5 Speed setting suggestions" for further information on the most suitable speed to use.

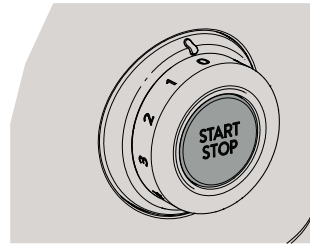

Speeds 1 - 4 allow continuous blending. You can stop the operation by pressing the **STOP** button.

The speed can be changed at any time during the blending process.



Important

- Do not operate manual speeds 1-4 for more than 1 minute at a time.
- When the blender jar is full or near the maximum capacity (6 cups), place one hand on the blender lid to avoid displacement of the lid during operation.
- The red LED flashes at regular intervals to indicate the presence of power both with and without the jar inserted in the base.



Use

6. You can add more ingredients while blending by removing the measuring cup and pouring ingredients through the hole in the lid.



7. If you have selected a speed between 1 and 4, when you have finished blending, press the **STOP** button, turn the knob to '0' and unplug the blender.

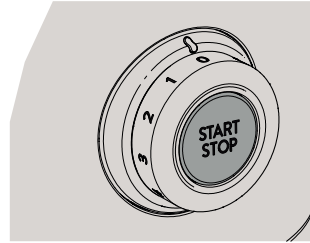

Canceling/stopping the blending cycle

The blending cycle can be canceled or stopped at any time by pressing the **START/ STOP** button.



3.4 Functions

Safety lock system

The blender has a safety lock system which automatically shuts off the blender when the jar is removed from the base. It also features a **motor safety cut-out** which trips if the motor is overloaded.

Smooth Start

The Smooth Start function starts the appliance up with a reduced initial speed, regardless of the speed set with the control knob.

The speed progressively increases until the set speed is reached.

The Smooth Start function allows you to process ingredients gradually to improve the blending results.



The Smooth Start only works when a speed between 0 and 4 is selected and does not work with the **PULSE** mode, **ICE CRUSH** or **SMOOTHIE** programs.

PULSE function

Pressing the **PULSE** button operates the blender at maximum speed.

The blender shuts off immediately when the button is released.

You should use a minimum quantity of 3 1/2 oz, not blending for more than 5 seconds consecutively, or 2 seconds when using dry ingredients.



The **PULSE** function does not work in combination with the **ICE CRUSH** or **SMOOTHIE** programs.

Ice Crush and Smoothie

The pre-set 'Ice Crush' and 'Smoothie' programs automatically adjust the speed to optimize blending results for a certain factory set time, then turn off automatically.

Use the **ICE CRUSH** program with short bursts of power when blending drinks containing ice cubes or frozen fruit.

Use the **SMOOTHIE** program to blend fruits, ice cream and yogurt into thick smoothies, blended drinks and milkshakes.

Pre-set time

Ice crush: approximately 50 seconds



Smoothie: approximately 60 seconds

When one of the two above-mentioned pre-set programs is selected, and after you have pressed the **START** button, the blender will automatically start to operate, and the central knob LED will light up to indicate that the cycle has been activated.



Use

3.5 Speed setting suggestions

Speed	Suitable for
 PULSE	<ul style="list-style-type: none">• Ice cubes• Meat• Self-clean option ("4.5 Using the Self-clean option").
1 or 2	<ul style="list-style-type: none">• Mousses/Sorbets• Batters/Salad dressings• Blended frozen drinks
3 or 4	<ul style="list-style-type: none">• Soups/Creamed soups• Whipped cream• Milkshakes/Smoothies• Pesto/Fruit or vegetable purées
 SMOOTHIE	<ul style="list-style-type: none">• Smoothies and milkshakes• Smoothies with frozen fruit
 ICE CRUSH	<ul style="list-style-type: none">• Ice cubes• Pieces of frozen fruit/vegetables



The speeds indicated in the table are approximate and can vary depending on the recipe and on the interaction of the different ingredients used.



Tips for using your blender

- Cut the food to be blended into cubes to obtain better results.
- Use the **PULSE** function for no more than 2 seconds at a time when blending dry mixtures. You might need to stop operation to push the ingredients down the sides of the blender jar with a spatula.
- When blending together liquid and dry ingredients, blend liquids first and then add the dry ingredients.
- Always remove pits from fruit and bones from meat as they can damage the blade assembly.
- Do not let food residues dry on the jar and blades for too long, as they could be very difficult to remove. If you cannot clean it right away, pour in a little warm water and let it soak.
- Do not process hot food. Let it cool to room temperature before blending.



Cleaning and Care

4 Cleaning and Care

4.1 Instructions



Improper use
Danger of electrocution

- Unplug the blender before cleaning it.
- Do not immerse the motor base in water or other liquids.



Improper use
Risk of damage to surfaces

- Do not use steam jets to clean the appliance.
- Do not use cleaning products containing chlorine, ammonia or bleach on parts with metallic finishes (e.g. anodized, nickel- or chrome-plated).
- Do not use abrasive or corrosive detergents (e.g. powder products, stain removers and metallic scourers).
- Do not use rough or abrasive materials or sharp metal scrapers.

4.2 Maintenance

All service should be performed by an authorized service representative.

4.3 Cleaning the motor base

To keep the blender's motor base outside surfaces in good condition, they should be cleaned regularly after use. Use soft, damp cloth with mild detergent.

4.4 Cleaning the blender jar and blade assembly

Clean the appliance following the instructions in section "3.2 How to remove the blade assembly".



Sharp blades
Danger of cuts

- Never touch the blades with your hands.
- Remove the blade assembly using the measuring cup only.

4.5 Using the Self-clean option

The blender jar and blade assembly can be cleaned using the Self-clean option:

1. Fill the jar with warm water and mild detergent.
2. Turn the control knob to the setting **1**.
3. Press the **START** button.
4. Press the **PULSE** button for 2 seconds at a time. Repeat the operation about 10 times.
5. Remove the jar, empty and rinse it.
6. Dry thoroughly.

4.6 Cleaning other blender parts

The blender lid and measuring cup can be washed in warm soapy water or in the dishwasher.

Make sure they have dried completely before fitting them back on the blender.



4.7 What to do if...

Problem	Possible cause	Solution
The motor will not start	The motor has overheated.	Unplug the blender and leave the motor to cool.
	The plug is not properly inserted in the power socket.	Insert the plug into the power socket. Do not use adaptors or extensions. Check that the house main breaker is on.
	The cable is defective.	Contact an Authorized Service Center.
	Lack of power.	Check that the house main breaker is on.
The blender vibrates	The blender is not resting on a stable surface.	Place the blender on a flat, stable surface.
	The anti-slip rubber feet are worn.	Have them replaced at an Authorized Service Center.
	The speed used is too high or the load is excessive	Set a lower speed and ensure the jar has not been overfilled.



Cleaning and Care

Problem	Possible cause	Solution
The blender switches on, but the blades do not turn	The jar has not been correctly locked into its base.	Remove the jar from its base and lock it into place.
The blender stops while operating	The motor has overheated.	Unplug the blender and leave the motor to cool.
The blender stops during operation and the white LED flashes	The blades may have jammed.	Unplug the blender and free the blades with a spatula.



If the problem has not been resolved or in the event of another type of fault, contact your local technical support center.



5 Recipes

Mixed fruit smoothie

Ingredients:

- 2 nectarines, pits removed (or canned peaches in syrup) and cut into pieces
- 4 1/2 oz frozen raspberries
- 4 1/2 oz frozen strawberries
- 1/2 cup orange juice
- 1/2 cup apple juice

Method

1. Put the nectarine pieces and the juices into the blender jar.
2. Add the frozen fruit.
3. Turn the control knob to the **Smoothie** program and start the blender by pressing the **START** button.
4. Let it run for 40 seconds.

Soy milk

Ingredients for 1 quart of soy milk:

- 3 1/2 oz yellow soy beans
- 1 1/2 quarts water

Method

1. Wash the yellow soy beans in cold water, discard the water then cover in fresh cold water and leave them to soak for 18-24 hours.
2. After they have soaked for 24 hours, wash the soy beans, drain them and then blend them with 1 2/3 cups of the water at speed **4** for 40 seconds, until you obtain a homogeneous paste.
3. Bring the remaining water almost to a boil in a pan.
4. Add the blended soy and cook, skimming off any foam which might form. Cook for 20 minutes from when it begins to boil.
5. Turn off the heat and leave to rest for 20 minutes.
6. After 20 minutes, strain the soy milk through clean muslin into a bottle.
7. You can sweeten and flavor the milk as you prefer, using vanilla, honey, malt extract or various syrups.



Recipes

Whipped cream

Ingredients:

- 2 cups cold whipping cream
- 1/3 cup powdered sugar

Method

1. Whip the cream in the blender at speed **3** for approximately 30 seconds.
2. Stop the operation by pressing the **STOP** button.
3. Add the icing sugar.
4. Select speed **4** and whip for a further 15 seconds, until the cream is fully whipped.

Vegetable purée

Ingredients:

- 10 oz zucchini
- 1/2 cup water or vegetable stock

Method

1. Steam the zucchini and cut it into rounds.
2. Put the pieces in the blender and blend for 45 seconds at speed **4**, adding a little water or vegetable stock at a time until you obtain a homogeneous purée.



The cream can also be whipped without icing sugar.

In this case, select speed **4** and whip for 40 seconds.

The manufacturer reserves the right to make any changes deemed useful for improvement of his products without prior notice. The illustrations and descriptions contained in this manual are therefore not binding and are merely indicative.

Le constructeur se réserve la faculté d'apporter, sans préavis, toutes les modifications qu'il jugera utiles pour l'amélioration de ses produits. Les illustrations et les descriptions figurant dans ce manuel ne sont pas contraignantes et n'ont qu'une valeur indicative.

El fabricante se reserva el derecho a aportar sin aviso previo todas las modificaciones que considere útiles para la mejora de sus propios productos. Las ilustraciones y las descripciones contenidas en este manual no comprometen, por tanto, al fabricante y tienen un valor meramente indicativo.



914776188/D