



ENGLISH

OWNER'S MANUAL

# REFRIGERATOR

**Read this owner's manual thoroughly before operating the appliance  
and keep it handy for reference at all times.**

LRKNC0505V



MFL69721105  
Rev.00\_031320

[www.lg.com](http://www.lg.com)

Copyright © 2020 LG Electronics Inc. All Rights Reserved.

# TABLE OF CONTENTS

## 3 PRODUCT FEATURES

---

## 4 SAFETY INSTRUCTIONS

---

4 IMPORTANT SAFETY INSTRUCTIONS

## 8 PRODUCT SPECIFICATIONS

---

## 9 PRODUCT OVERVIEW

---

9 Exterior and Interior

10 Kimchi Containers

## 11 INSTALLATION

---

11 Installation Overview

12 Unpacking the Refrigerator

12 Choosing the Proper Location

13 Leveling

13 Turning on the Power

## 14 OPERATION

---

14 Before Use

15 Control Panel

20 Food Storage Guide

## 22 SMART FUNCTIONS

---

22 LG ThinQ Application

22 Smart Diagnosis™ Feature

## 23 MAINTENANCE

---

23 Cleaning

## 25 TROUBLESHOOTING

---

25 FAQs

26 Before Calling for Service

## 31 LIMITED WARRANTY

---

# PRODUCT FEATURES

Depending on the model, some of the following functions may not be available.

## STORES A VARIETY OF FOOD

This new model can be used not only to store and ferment kimchi, but also as a refrigerator or freezer, greatly expanding its usability.

## HIGH-QUALITY AIRTIGHT KIMCHI CONTAINERS

The kimchi containers are easy to use and airtight, to keep kimchi tasting fresh.  
(The shape of the kimchi containers may vary by model.)

## POWERFUL DEODORIZING FUNCTION

There are deodorizers in the left and right compartments to eliminate odors before they spread.

## EASY-OPEN/EASY-CLOSE CONTAINER LIDS

The lids are designed with dampers to open and close softly.

## EASY INSTALLATION

The appliance can be installed in any location that maintains a temperature between 55 °F(13 °C) and 110 °F (43 °C).

# SAFETY INSTRUCTIONS

## ***READ ALL INSTRUCTIONS BEFORE USE***

### **Your safety and the safety of others are very important.**

We have provided many important safety messages in this manual and on your appliance. Always read and follow all safety messages.

-  This is the safety alert symbol.  
This symbol alerts you to potential hazards that can kill or injure you and others.  
All safety messages will follow the safety alert symbol and either the word **WARNING** or **CAUTION**.

These words mean:

### **WARNING**

You may be killed or seriously injured if you do not follow instructions.

### **CAUTION**

You may be injured or cause damage to the product if you do not follow instructions.

All safety messages will tell you what the potential hazard is, tell you how to reduce the chance of injury, and tell you what may happen if the instructions are not followed.

## IMPORTANT SAFETY INSTRUCTIONS

### **WARNING**

**To reduce the risk of explosion, fire, death, electric shock, scalding or injury to persons when using this product, follow basic precautions, including the following:**

#### **INSTALLATION**

- To reduce the risk of injury to persons, adhere to all industry recommended safety procedures including the use of long-sleeved gloves and safety glasses.
- Never attempt to operate this appliance if it is damaged, malfunctioning, partially disassembled, or has missing or broken parts, including a damaged cord or plug.
- Only connect this product to a dedicated grounded electrical outlet rated for use with this product (115 V, 60 Hz, AC only). It is the user's responsibility to replace a standard 2-prong wall outlet with a standard 3-prong wall outlet.
- Do not use an outlet that can be turned off with a switch. Do not use an extension cord.
- The appliance must be positioned for easy access to a power source.
- When moving the refrigerator, be careful not to roll over or damage the power cord.
- Contact an authorized service center when installing or relocating the refrigerator.
- Do not, under any circumstances, cut or remove the third (ground) prong from the power cord.
- Keep packing materials out of the reach of children. Packaging material can be dangerous for children. There is a risk of suffocation.

- Do not install the refrigerator in a damp or dusty place where insulation on electrical parts may deteriorate.
- Do not place the refrigerator in direct sunlight or expose it to the heat from heating appliances such as stoves or heaters.
- Do not bend or pinch the power cord excessively or place heavy objects on it.

## OPERATION

- This appliance is intended to be used in household and similar applications such as
  - Staff kitchen areas in shops, offices and other working environments;
  - Farm houses and by clients in hotels, motels and other residential type environments;
  - Bed and breakfast type environments;
  - Catering and similar non-retail applications.
- This product is not to be used for special purposes such as the storage of medicine or test materials or for use on ships, etc.
- DO NOT allow children to climb, stand, or hang on the refrigerator doors or on the shelves in the refrigerator. They could damage the refrigerator and seriously injure themselves.
- Do not allow children to climb into the refrigerator. They could be trapped and suffocated.
- Children should be supervised to ensure that they do not play with the refrigerator.
- Keep fingers out of pinch point areas; clearances between the doors and cabinets are necessarily small. Be careful closing doors when children are nearby.
- Do not touch frozen food or the metal parts in the freezer compartment with wet or damp hands. Doing so may cause frostbite.
- Do not refreeze frozen food that has thawed completely. Doing so may result in a serious health hazard.
- If the refrigerator is fitted with light bulbs that require replacing, unplug the refrigerator or turn off the power before doing so.
- Do not use an adapter plug or plug the power plug into a multi-outlet extension cord.
- Do not use a cord that shows cracks or abrasion damage along its length or at either the plug or connector end. Immediately have all power cords that have become frayed or otherwise damaged repaired or replaced by qualified service personnel.
- Do not operate the refrigerator or touch the power cord with wet hands.
- Do not modify or extend the power cord.
- Do not use an uncertified power outlet. Do not plug appliance into a damaged wall outlet.
- Do not put hands, feet or other objects into the air vents or bottom of the refrigerator. Doing so could result in personal injury or electric shock.
- In the event of a gas leak (propane/LPG), ensure the area is adequately ventilated and contact an authorized service center before resuming use. Do not touch the refrigerator or power cord of the refrigerator.
- Disconnect the power cord immediately and contact an authorized service center if there is a strange noise, odor, or smoke coming from the appliance.
- Do not use any fuse (such as copper, steel wire, etc.) other than a standard fuse.
- Do not place or use an electrical appliance inside the refrigerator, unless it is of a type recommended by the manufacturer.
- Do not put animals inside the appliance.
- Do not place heavy or fragile objects, liquid filled containers, combustible substances, or flammable objects (such as candles and lamps) on the appliance.
- Keep or dispose of the packing materials out of reach of children. Plastic packing materials pose a risk of suffocation.
- If connected to a circuit protected by fuses, use time delay fuse.

## MAINTENANCE

- Do not use a hair dryer to dry the inside of the refrigerator.
- Do not light a candle to remove odors in the refrigerator.
- In the event of a refrigerant leak, move flammable objects away from the refrigerator. Ensure the area is adequately ventilated and contact an authorized service center.
- Keep flammable materials and vapors, such as gasoline, away from the refrigerator.
- Unplug the power plug before cleaning or repairing the refrigerator.
- Unplug the power plug immediately in the event of a blackout or thunderstorm.
- Turn the power off if water or dust penetrates into the refrigerator. Call a service agent.
- Do not store glass containers or soda in the freezer compartment. Contents may expand when frozen, break the container and cause injury.
- Do not store, disassemble or repair the appliance yourself or allow unqualified personnel to do so.

## DISPOSAL

- Junked or abandoned refrigerators are dangerous, even if they are sitting for only a few days. When disposing of the refrigerator, remove the packing materials from the door or take off the doors but leave the shelves in place so that children may not easily climb inside.
- If disposing of a refrigerator, make sure the refrigerant is removed for proper disposal by a qualified servicer. If you release the refrigerant, you may be fined or imprisoned in accordance with the relevant environmental law.

## WARNING

- Keep ventilation openings, in the appliance enclosure or in the built-in structure, clear of obstruction.
- Do not use mechanical devices or other means to accelerate the defrosting process, other than those recommended by the manufacturer.
- Do not damage the refrigerant circuit.
- Do not use electrical appliances inside the food storage compartments of the appliance, unless they are of the type recommended by the manufacturer.
- The refrigerant and insulation blowing gas used in the appliance require special disposal procedures. When disposing, please consult with service agent or a similarly qualified person.

## Risk of Fire and Flammable Materials



This appliance contains a small amount of isobutane refrigerant (R600a), which is combustible. When transporting and installing the appliance, care should be taken to ensure that no parts of the refrigerating circuit are damaged. Refrigerant squirting out of the pipes could ignite or cause an eye injury. If a leak is detected, avoid any naked flames or potential sources of ignition and air the room in which the appliance is standing for several minutes.

In order to avoid the creation of a flammable gas air mixture if a leak in the refrigerating circuit occurs, the size of the room in which the appliance may be sited depends on the amount of refrigerant used. The room must be 10.8 square feet (1 square meter) in size for every 8g of R600a refrigerant inside the appliance. The amount of refrigerant in your particular appliance is shown on the identification plate inside the appliance. Never start up an appliance showing any signs of damage. If in doubt, consult your dealer.

## GROUNDING INSTRUCTIONS

- Improper connection of the equipment-grounding conductor can result in a risk of electric shock. Check with a qualified electrician or service person if you are in doubt whether the appliance is properly grounded. Do not modify the plug provided with the appliance; if it will not fit the outlet, have a proper outlet installed by a qualified electrician.
- Have a certified electrician check the wall outlet and wiring for proper grounding.
- Never unplug the appliance by pulling on the power cord. Always grip the plug firmly and pull straight out from the outlet. Failure to do so may damage the power cord, resulting in a risk of fire and electric shock.

## CAUTION

**To reduce the risk of minor or moderate injury to persons, malfunction, or damage to the product or property when using this product, follow basic precautions, including the following:**

### INSTALLATION

- Do not install the refrigerator where there may be a danger of the unit falling.
- The refrigerator must be properly installed in accordance with the Installation Instructions.

### OPERATION

- Do not use aerosols near the refrigerator.
- This appliance is intended to be used only in domestic and similar applications.
- Do not strike or apply excessive force to any glass surface. Do not touch glass surfaces if they are cracked or broken.
- Do not overfill the appliance with food. Doing so may cause personal injury or property damage.

### MAINTENANCE

- Do not use strong detergents like wax or thinners for cleaning. Clean with a soft cloth.
- Remove foreign objects (such as dust and water) from the prongs of the power plug and contact areas. Do not use a wet or damp cloth when cleaning the plug.
- Do not spray water directly on the inside or outside of the refrigerator.
- Do not clean glass shelves or covers with warm water when they are cold. They may break if exposed to sudden temperature changes.

**SAVE THESE INSTRUCTIONS**

# PRODUCT SPECIFICATIONS

The appearance and specifications listed in this manual may vary due to constant product improvements.

**Electrical requirements:** 115 V, 60 Hz

<b>Model LRKNC0505V</b>	
<b>Description</b>	Refrigerator
<b>Net weight</b>	90 lb (41 kg)



# PRODUCT OVERVIEW

The images in this guide may be different from the actual components and accessories, which are subject to change by the manufacturer without prior notice for product improvement purposes.

## Exterior and Interior

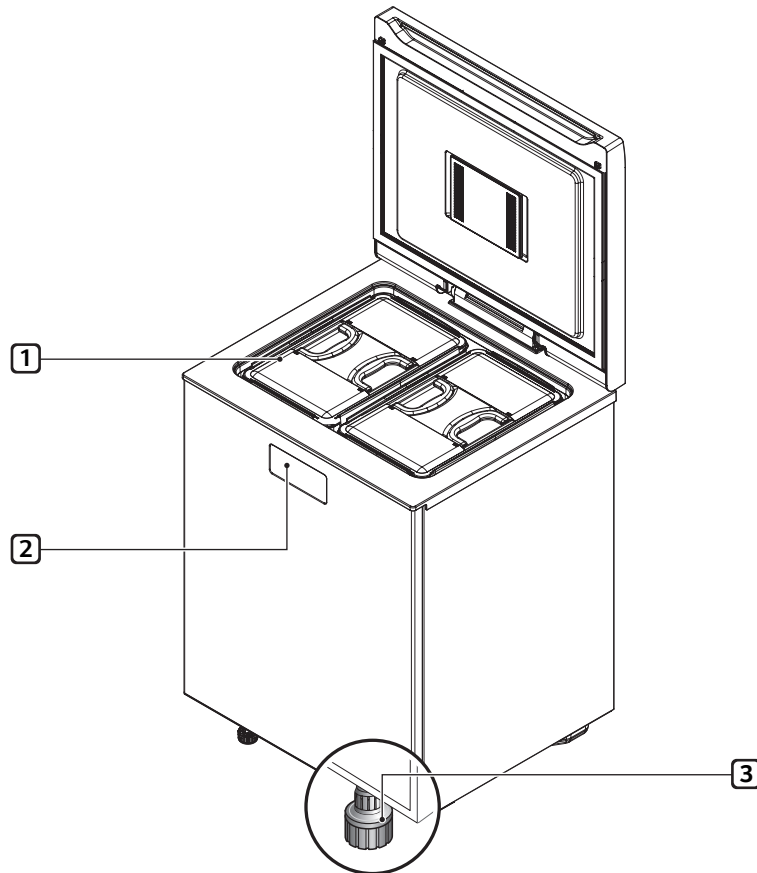

**1 Kimchi Container**

Place food in the kimchi container and close securely before storing.

**2 Control Panel**

Set controls using temperature or food type.

**3 Leveling Leg**

Extend or retract the legs to level the appliance.

## Kimchi Containers

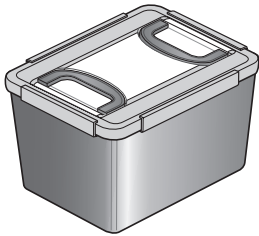
Model	Kimchi Container	Part NO	Capacity
LRKNC0505V		AKC72909303 : 6EA	3 1/2 gal (13.1 L)

# INSTALLATION

## Installation Overview

Please read the following installation instructions first after purchasing this product or transporting it to another location.

ENGLISH

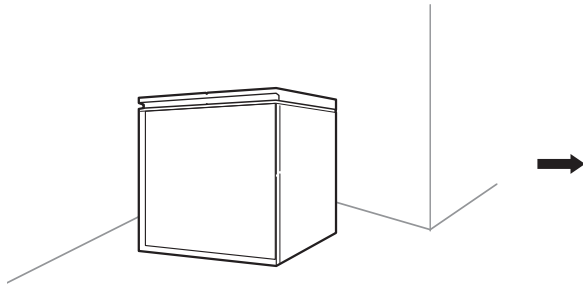

Unpacking the Refrigerator

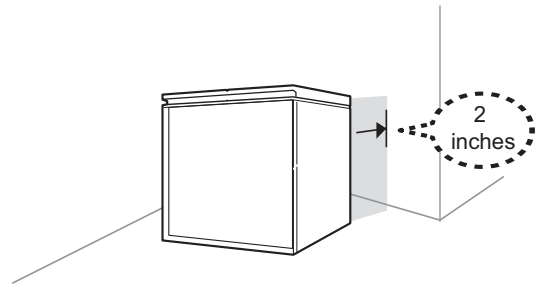

Choosing the Proper Location

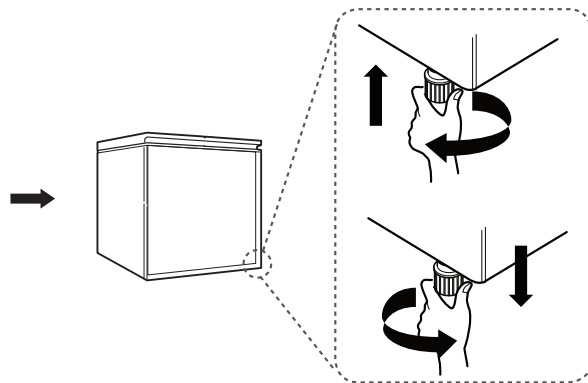

Leveling

## Unpacking the Refrigerator

### WARNING

- Use two or more people to move and install the refrigerator. Failure to do so can result in back injury or other injury.
- The refrigerator is heavy. Protect the floor when moving the refrigerator for cleaning or service. Always pull the refrigerator straight out when moving it. Do not wiggle or walk the refrigerator when trying to move it, as floor damage could occur.
- Keep flammable materials and vapors, such as gasoline, away from the refrigerator. Failure to do so can result in fire, explosion, or death.

### NOTE

- Remove tape and any temporary labels from your refrigerator before using. Do not remove any warning labels, the model and serial number label, or the circuit diagram that is located behind the refrigerator.
- To remove any remaining tape or glue, rub the area briskly with your thumb. Tape or glue residue can also be easily removed by rubbing a small amount of liquid dish soap over the adhesive with your fingers. Wipe with warm water and dry.
- Do not use sharp instruments, rubbing alcohol, flammable fluids, or abrasive cleaners to remove tape or glue. These products can damage the surface of your refrigerator.
- Reinstall or adjust shelves as needed. Refrigerator shelves are installed in the shipping position. Reinstall shelves according to your individual storage needs.

## Choosing the Proper Location

### Electricity

Use an individual, grounded outlet: 115 Volts, 60 Hz, AC, 15 Amps minimum.

### WARNING

- To reduce the risk of electric shock, do not install the refrigerator in a wet or damp area.
- Do not install in any outdoor or sheltered outdoor location or in direct sunlight.
- Do not overload house wiring and cause a fire hazard by plugging in multiple appliances in the same outlet with the refrigerator.

### Flooring

To avoid noise and vibration, the unit must be installed and leveled on a solidly constructed floor. If required, adjust the leveling legs to compensate for the unevenness of the floor.

### NOTE

- Installing on carpeting, soft tile surfaces, a platform or weakly supported structure is not recommended.

### Ambient Temperature

Install this appliance in an area where the temperature is between 55 °F (13 °C) and 110 °F (43 °C).

If the temperature around the appliance is too low or high, cooling ability may be adversely affected.

### Dimensions and Clearances

- Check the dimensions of the appliance and the installation path to ensure there is sufficient room to move the refrigerator through doors or narrow openings.
- The installation location chosen for the refrigerator should allow space behind the unit for connections and airflow and space above it to open the door.
- Too small of a distance from adjacent items may result in lowered freezing capability and increased electricity consumption charges. Allow at least 2 inches (50.8 mm) between the back of the refrigerator and the wall.
- Remember to allow enough room above the refrigerator to fully open the door.

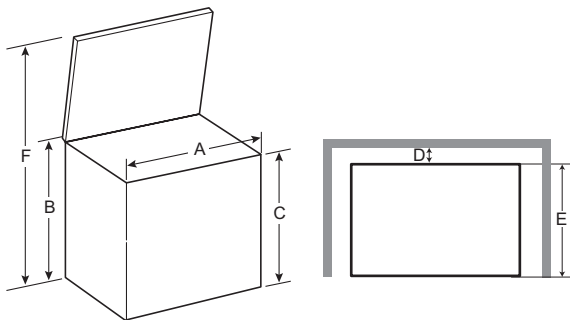

-	Dimensions/ Clearances	LRKNC0505V
A	Width	26 1/4" (666 mm)
B	Height to Top of Cover	35 7/16" (900 mm)
C	Height to Top of Case	33" (837 mm)
D	Back Clearance	2" (50 mm)
E	Depth	24" (612 mm)
F	Height with Door Open	57" (1445 mm)

### Leveling

For proper operation, make sure the product is level, with all leveling legs in firm contact with the floor. If the product seems unsteady, adjust the leveling legs.

The leveling legs can be turned easily by tipping the cabinet slightly. Turn the legs to the left to raise the product or to the right to lower it.

### Turning on the Power

- After installing, plug the refrigerator's power cord into a 3-prong grounded outlet and push the refrigerator into the final position.

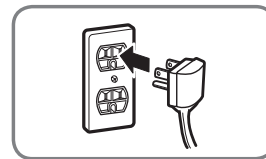

#### **CAUTION**

- Connect to a rated power outlet.
- Have a certified electrician check the wall outlet and wiring for proper grounding.
- Do not damage or cut off the ground terminal of the power plug.

# OPERATION

## Before Use

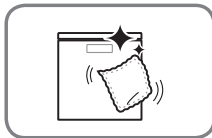

### Clean the refrigerator.

Clean the refrigerator thoroughly and wipe off all dust that accumulated during shipping.

### CAUTION

- Do not scratch the refrigerator with a sharp object or use a detergent that contains alcohol, a flammable liquid or an abrasive when removing any tape or adhesive from the refrigerator. Remove adhesive residue by wiping it off with your thumb or dish detergent.
- Do not peel off the model or serial number label or the technical information on the rear surface of the refrigerator.

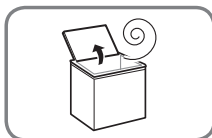

### Open refrigerator door to ventilate the interior.

The inside of the refrigerator may smell like plastic at first. Remove any adhesive tape from inside the refrigerator and open the refrigerator door for ventilation.

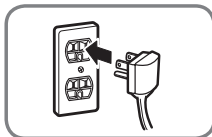

### Connect the power supply.

Check if the power supply is connected before use.

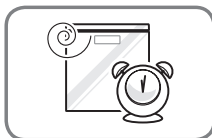

### Wait for the refrigerator to cool.

Allow the refrigerator to run for at least two to three hours before putting food in it. Check the flow of cold air in the compartments to ensure proper cooling.

### CAUTION

- Putting food in the refrigerator before it has cooled could cause the food to spoil, or a bad odor to remain inside the refrigerator.

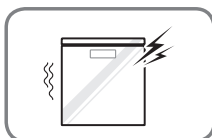

### The refrigerator makes a loud noise after initial operation.

This is normal. The volume will decrease as the temperature decreases.

## Control Panel

Depending on the model, some of the following functions may not be available.

- Before storing or fermenting kimchi, use this section to become more familiar with the parts and functions of the control panel.
- Before using the LG kimchi refrigerator, press and hold the Lock button for 3 seconds to unlock the display.

### Control Panel Features

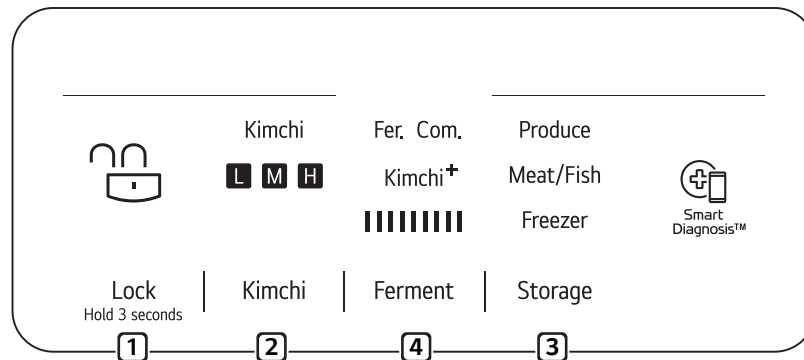

#### NOTE

- After 60 seconds of idle time, all lights on the display except the Lock icon (  ) are turned off to save power. This is normal operation. Press any button to wake the display and show current settings.
- Before using functions, you must press and hold the Lock button for 3 seconds to unlock the display.

#### 1 The Lock function prevents children or others from accidentally changing settings.

- Before changing settings, press and hold Lock for 3 seconds to unlock the display.
- After changing settings, press and hold Lock for 3 seconds to lock the display and prevent accidental changes.
- ※ The Lock function locks all display functions except for the Lock button. If a button is pressed, the Lock icon will blink 3 times. The Lock function is automatically turned on after 60 seconds if the control panel remains idle.
- ※ The display turns on automatically when the refrigerator is plugged in.

#### 2 Press to select a temperature for storing kimchi.

**Kimchi:** M → H → L

- Select the appropriate temperature for the type and salinity of kimchi.
- L=Low Cooling (cold)  
M=Medium Cooling (colder)  
H=High Cooling (coldest)

#### 3 Press to set up the compartment for refrigerating food.

**Storage:** Produce → Meat/Fish → Freezer

- Select the appropriate temperature for the type of food being stored.

#### 4 Press to set up the compartment for normal kimchi fermentation or for Kimchi+ fermentation.

**Ferment:** Fer. → Kimchi+

- When set to Kimchi+, the bars light up as the fermentation progresses.

## Storing Kimchi

Once the appliance is connected to power, the display is activated. If desired, the product can be used to store kimchi at the default settings without setting up additional refrigerator functions.

- The display turns on automatically when the refrigerator is plugged in.

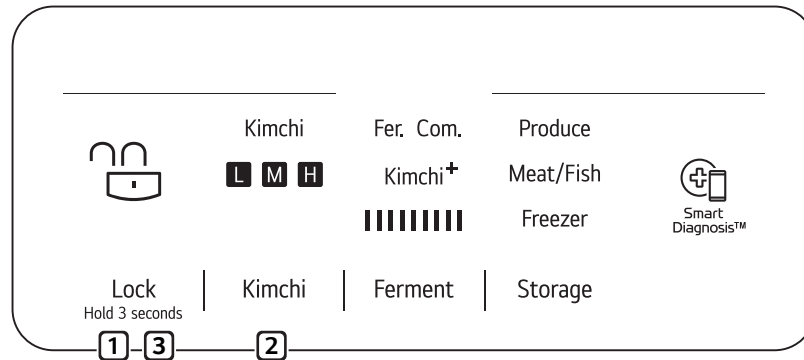

### 1 Unlock the display.

- Press and hold the Lock button for approximately 3 seconds to unlock the display.
- The display must be unlocked before settings can be changed.

### 3 Lock the display.

- Press and hold the Lock button for 3 seconds to lock the display.

### 2 Press the Kimchi button.

- Press the button repeatedly to cycle through the settings.
- As the button is pressed, the settings change in the order shown.

**Kimchi: M→H → L**

- L=Low Cooling (cold)
- M=Medium Cooling (colder)
- H=High Cooling (coldest)



## Fermenting Kimchi

Kimchi ferments more quickly at the Ferment setting than at the Kimchi setting.

- The display turns on automatically when the refrigerator is plugged in.

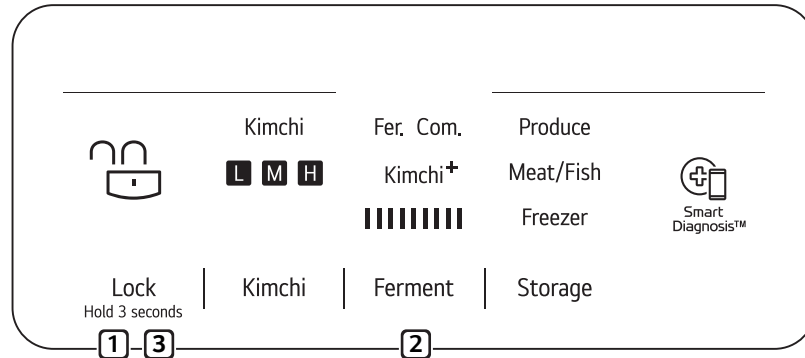

### 1 Unlock the display.

- Press and hold the Lock button for approximately 3 seconds to unlock the display.
- The display must be unlocked before settings can be changed.

### 2 Press the Ferment button.

- Press the button repeatedly to cycle through the settings.
- As the button is pressed, the settings change in the order shown.

**Fer. → Kimchi+**

#### NOTE

- Once fermentation is complete, Fer. Com. lights up. Fermentation time depends on the season and the room temperature.

### 3 Lock the display.

- Press and hold the Lock button for 3 seconds to lock the display.

#### Canceling Fermentation

- To cancel fermentation, unlock the display and select a different setting.

#### Storing Fermented Kimchi

- When fermentation is complete, the Fer. Com. (Fermentation Complete) text lights up and Kimchi M appears in the temperature display.
- Unlock the display to turn off the Fer. Com. indicator and change settings.

## Using the Produce, Meat/Fish and Freezer Settings

- Produce setting: Designed to keep vegetables and fruit fresh for a long time.
- Meat/Fish setting: Designed to keep meat and fish fresh.
- Freezer setting: Stores frozen food.
- The display turns on automatically when the refrigerator is plugged in.

### NOTE

- If kimchi is stored at the Meat/Fish setting, it may freeze.

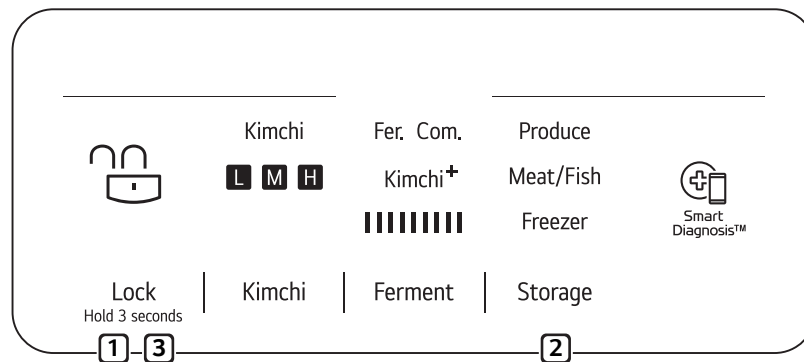

### 1 Unlock the display.

- Press and hold the Lock button for approximately 3 seconds to unlock the display.
- The display must be unlocked before settings can be changed.

### 2 Press the Storage button.

- Press the button repeatedly to cycle through the settings.
- As the button is pressed, the settings change in the order shown.

**Storage: Produce → Meat/Fish → Freezer**

### 3 Lock the display.

- Press and hold the Lock button for 3 seconds to lock the display.
- Remove all frozen food before switching from Freezer to another setting.
- Refreezing food that has thawed can lead to food-borne illnesses.

## Using the Kimchi+ Setting

- The display turns on automatically when the refrigerator is plugged in.

### Kimchi+

- Use this setting to rapidly cool cabbage kimchi and encourage lactic acid fermentation to keep kimchi fresher longer.
- ※ Use this setting only for freshly prepared cabbage kimchi. Less salty types of kimchi may freeze if stored at this setting.
- ※ Using the setting twice may over-ferment the kimchi. Use it only once.
- ※ The light bars in the display indicate the fermentation process. The kimchi is ready to eat when all the bars are lit (approximately 6 days).

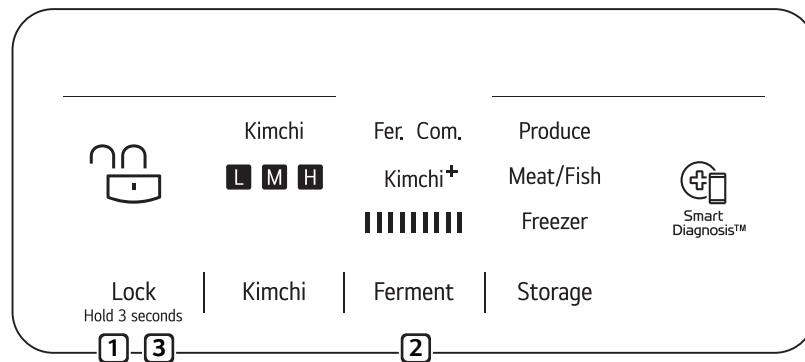

### 1 Unlock the display.

- Press and hold the Lock button for approximately 3 seconds to unlock the display.
- The display must be unlocked before settings can be changed.

### 2 Press the Ferment button.

- Press the button repeatedly to cycle through the settings.
- As the button is pressed, the settings change in the order shown.

**Fer. → Kimchi+**

### 3 Lock the display.

- Press and hold the Lock button for 3 seconds to lock the display.

## Food Storage Guide

### Food Storage Tips

#### Storing Vegetables and Fruit

- The moisture left on vegetables after washing can make them spoil faster. Wait to wash vegetables until just before use.
- Leafy greens like kale or lettuce have a limited storage life. Wrap them in newspaper or in sealed containers to help them stay fresh longer.
- Do not store tropical fruits in the refrigerator.
- Bananas or uncut pineapples are damaged by cold temperatures.

### Kimchi Storage Tips

#### Do not overfill the kimchi containers.

- Allow space for the kimchi to expand as it ferments or the contents may overflow the container. Close the container lids completely to prevent the kimchi from fermenting too quickly or developing yeast mold. Fill the container with kimchi up to the fill line and make sure the lid is tightly closed before storing. Cover the surface of the kimchi with plastic wrap to extend the storage time.

#### Do not place kimchi directly into the refrigerator compartment or store it in a plastic bag.

- Use the kimchi container provided to store kimchi. Kimchi placed directly into the refrigerator compartment may freeze and taste off. Do not block the air outlet inside the refrigerator with food. Doing so could cause the food to freeze, affect product performance, or result in electric shock or injury.

#### For best results, check on kimchi within 3 to 4 days of storing it.

- If the kimchi has overflowed from the container, it may ferment too quickly and not store well.

#### Be sure to use enough salt when preparing kimchi for longer storage.

- The rate of fermentation is mostly determined by the amount of salt in the kimchi. Small batches of mild kimchi can be successfully stored for short periods, but add more salt if storing large amounts for use over an extended period.

#### Use care when placing kimchi containers in the refrigerator.

- Lift the container by the handles and avoid impacts to the bottom of the container. (The appearance of kimchi containers may vary by model.)

#### Do not place foods that require different storage conditions in the same compartment.

- Select the appropriate settings for the food being stored.

## A Guide to Kimchi

### The first step in fermenting kimchi is salt pickling.

- The salt reacts with enzymes in the cabbage to break down proteins and begin fermentation immediately. This process continues even at cold temperatures. Traditionally, kimchi was allowed to ferment slowly during the cold winter weather.

### The taste of kimchi also depends on the seasonings used.

- Typical seasonings include green onion, garlic, ginger, salted fish, and chili powder. The combination of spices chosen determines the overall taste of the kimchi.

### Fermentation Rates for Kimchi

- Adding a lot of garlic, seafood, onions, chili powder, cucumber or green onions makes kimchi ferment more quickly. Adding salted oysters, salted shrimp or persimmon sauce really speeds up fermentation. On the other hand, adding leeks, mustard or ginseng slows down fermentation.

### Kimchi begins fermenting as soon as it is prepared.

- Contact with air will make kimchi sour. If the kimchi is not covered in sauce or has too little salt, a thin skin of yeast will form on its surface. Keep air away from the vegetables by covering them in sauce or placing the kimchi in a plastic bag or covering it with plastic wrap.

### How Temperature Affects Kimchi

- Temperature affects the fermentation rate of kimchi. When preparing kimchi for long-term storage, keep the temperature below 50°F (10°C).

### Long-Term Storage of Kimchi

- Like cheese, kimchi is a living organism and will change over time. To keep kimchi fresh for long periods, increase the salt content and store at a low temperature, near 32°F (0°C). Press vegetables down so they are covered with sauce and cover the container with plastic wrap or a layer of cabbage leaves to keep air out and keep kimchi fresh longer.

### Choosing the Right Cabbage for Kimchi

- There are many different kinds of cabbage available. For kimchi, choose a medium sized cabbage which is rounded rather than long and thin. The inner leaves should be sweet and paler than the outer leaves. Outer leaves should be thin and light green.

### Selecting Radishes for Kimchi

- There are many types of radish kimchi, and different radishes are used for different types of kimchi.
- For radish kimchi, use Korean radishes that have pale green tops and well-spread leaves.
- For chonggak (young radish) kimchi, use Seoul radishes that have round, thick bottoms.
- For kkakdugi (cubed radish kimchi), try to find radishes with white rather than green tops.
- For dongchimi, use radishes with soft leaves and white rather than green tops.

## Proper Food Storage Techniques

### Store kimchi in the kimchi container.

- Fill the container with kimchi only up to the fill line and make sure the lid is tightly closed before storing.
- If the lid is not closed properly, a thin film of yeast can form on the surface of the kimchi or the kimchi may ferment too quickly. Cover the surface of the kimchi with plastic wrap or a layer of cabbage leaves before storing it to prevent yeast from forming.

### Store vegetables or fruit in the designated container.

- Some vegetables and fruits are damaged by cold air.
- Vegetables which are damp from being washed tend to spoil more quickly. For best results, don't wash vegetables before storing them.
- Do not refrigerate tropical fruits like bananas or pineapples, which are damaged by cold temperatures.

### Allow hot food to cool to room temperature before refrigerating it.

- Placing hot food directly into the refrigerator can raise the temperature of surrounding food items, leading to spoilage and higher utility bills.

### Long-Term Storage of Kimchi

- Place newly prepared kimchi into the refrigerator and select the Kimchi setting.
- Depending on the type and saltiness of the kimchi, select the Low, Medium, or High setting.
- For best long-term storage, make sure the vegetables are completely submerged in the sauce and cover the kimchi with plastic wrap.

### Before storing vegetable oils in the refrigerator, read the storage instructions on the container.

- Vegetable oil bottles can become messy with use.
- Place oil bottles in disposable or left over plastic containers to avoid having to clean the storage containers.

### Select the appropriate temperature for the food being stored.

- Storing kimchi at the Fermentation setting may cause it to spoil.
- Some types of kimchi may freeze if stored at the High setting. Check on kimchi often when using the High setting.
- Storing other food along with kimchi in a storage container may result in the other food freezing.

## Using the Different Containers

- For best results when using the Produce or Meat/ Fish setting, store containers which are similar in size, smaller containers, or bottles.
- ※ Storing kimchi in the provided kimchi container in the designated position makes the most delicious kimchi.
- ※ Do not store kimchi in glass bottles. The kimchi will expand when frozen and the bottle may break, causing a risk of injury.
- ※ Do not place containers near the air outlet in the refrigerator. The food may freeze.

## Fermenting Kimchi

- Avoid opening the compartment door while kimchi is fermenting.
- Allowing the warmer outside air in during fermentation can affect the taste of the kimchi.

## Getting Rid of Food Odors

- Cover open food containers with plastic wrap before storing to prevent transfer of odors inside the refrigerator.

## After installation, allow the refrigerator to cool completely before storing food.

- Food may spoil and cause lingering odors if it is stored before the refrigerator has been allowed to reach the set temperature.

## CAUTION



- Do not store glass containers in the freezer. Contents may expand when frozen, break the container and cause injury.

## NOTE

- Food packaging should be wiped down to prevent adjacent foods from being contaminated.
- If the refrigerator is kept in a hot and humid place, frequent opening of the door or storing a lot of vegetables in the refrigerator may cause condensation to form. Wipe off the condensation with a clean cloth or a paper towel.
- If the refrigerator door is opened or closed too often, warm air may penetrate the refrigerator and raise its temperature. This can increase the running costs of the unit.

# SMART FUNCTIONS

## LG ThinQ Application

This feature is only available on models with the  or  logo.

The **LG ThinQ** application allows you to communicate with the appliance using a smartphone.

### LG ThinQ Application Features

- **Smart Diagnosis™**

- This function provides useful information for diagnosing and solving issues with the appliance based on the pattern of use.



#### NOTE

- This information is current at the time of publication. The application is subject to change for product improvement purposes without notice to users.

### Installing the LG ThinQ Application

Search for the **LG ThinQ** application from the Google Play Store or Apple App Store on a smart phone. Follow instructions to download and install the application.

## Smart Diagnosis™ Feature

This feature is only available on models with the  or  logo.

Use this feature to help you diagnose and solve problems with your appliance.

#### NOTE

- For reasons not attributable to LGE's negligence, the service may not operate due to external factors such as, but not limited to, Wi-Fi unavailability, Wi-Fi disconnection, local app store policy, or app unavailability.
- The feature may be subject to change without prior notice and may have a different form depending on where you are located.

## Using Audible Diagnosis to Diagnose Issues

Follow the instructions below to use the audible diagnosis method.

- Launch the **LG ThinQ** application and select the Smart Diagnosis feature in the menu. Follow the instructions for audible diagnosis provided in the **LG ThinQ** application.

- 1 Hold the Lock button for three seconds.

- If the display has been locked for over one minute, you must deactivate the lock and then reactivate it.

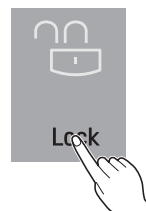

- 2 Press and hold the Ferment button until the display screen turns off.

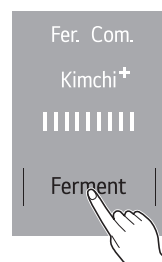

- 3 As soon as the display turns off, hold the microphone on your phone next to the display screen.

- The microphone on the phone must face the speaker opening on the refrigerator.

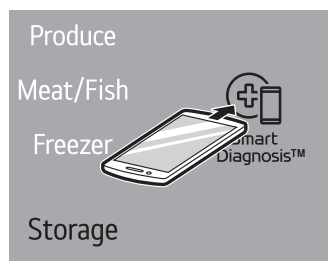

- 4 Keep the phone in place until the tone transmission has finished. The display will count down the time. Once the countdown is over and the tones have stopped, the diagnosis will be displayed in the application.

#### NOTE

- For best results, do not move the phone while the tones are being transmitted.

# MAINTENANCE

## Cleaning

### **! WARNING**

- Use non-flammable cleaner. Failure to do so can result in fire, explosion, or death.

### **! CAUTION**

- Do not use an abrasive cloth or sponge when cleaning the interior and exterior of the refrigerator.
- Do not place your hand on the bottom surface of the refrigerator when opening and closing the doors.

## General Cleaning Tips

- This model defrosts automatically; however, clean the compartment once a month to prevent odors.
- Wipe up spills immediately.
- Unplug the refrigerator or disconnect power before cleaning.
- Remove all removable parts, such as kimchi containers.
- Use a clean sponge or soft cloth and a mild detergent in warm water. Do not use abrasive or harsh cleaners.
- Hand wash, rinse and dry all surfaces thoroughly.

## Interior

If frost buildup inside the refrigerator makes it difficult to remove the kimchi containers, empty the compartment and turn the refrigerator off. Leaving the refrigerator door open will speed up defrosting. After ice has melted, wipe the interior of the compartment with a dry cloth. Do not attempt to defrost the refrigerator using other means or appliances. Doing so could cause a fire.

## Exterior

For products with black stainless steel exterior, spray glass cleaner on a clean, microfiber cloth and rub in direction of grain. Do not spray glass cleaner directly at the display panel. Do not use harsh or abrasive cleaners.

For products with a standard stainless steel exterior, use a damp microfiber cloth and rub in the direction of the grain. Dry with a paper towel to avoid streaks. For stubborn stains and fingerprints, use a few drops of liquid dish soap in water, and rinse with hot water before drying. Do not use abrasive or harsh cleaners.

## Inside Walls

- Allow compartment to warm up so the cloth will not stick.

To help remove odors, wash the inside of the refrigerator with a mixture of baking soda and warm water. Mix 2 tablespoons of baking soda to 1 quart of water (26 g soda to 1 liter water.) Be sure the baking soda is completely dissolved so it does not scratch the surfaces of the refrigerator.

## Door Liners and Gaskets

Use a clean sponge or soft cloth and a mild detergent in warm water. Do not use cleaning waxes, concentrated detergents, bleaches, or cleaners containing petroleum on plastic refrigerator parts.

## Plastic Parts (covers and panels)

Use a clean sponge or soft cloth and a mild detergent in warm water. Do not use glass cleaners, abrasive cleansers, or flammable fluids. These can scratch or damage the material.

## Condenser Coils

Use a vacuum cleaner with a brush or crevice attachment to clean the condenser cover and vents. Do not remove the panel covering the condenser coil area.

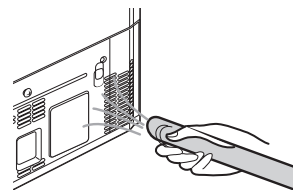

### Cleaning the Kimchi Containers

- Containers and bins can easily become dirty from spilled food. Remove them occasionally and rinse them out to avoid odors.
- Before cleaning the container lids, remove the rubber packing from inside the lid. Remember to replace the rubber packing once the lids are clean.
- Do not clean the containers and lids in water hotter than 122°F (50°C).
- Gently clean the containers with a soft sponge to avoid scratching the surface.
- Kimchi containers may emit a plastic odor when you first use them, so clean them using a soft sponge and neutral detergent.
- You can remove the smell from the kimchi container by placing finely chopped green leaves in, then cover it with a lid and leave it for around a day. Then leave rice rinse water in it for about 30 minutes and wipe the container clean.
- When used for a long period of time, the distinct color and odor of kimchi can permeate the container.

#### CAUTION

- Do not wash the lid of the kimchi container using a dishwasher or dryer.  
Hand-wash only.



# TROUBLESHOOTING

## FAQs

**Q: Why is my kimchi freezing?**

A: Kimchi's storage temperature is around 32°F (0°C). The exact freezing point of kimchi varies depending on the type of kimchi, seasoning, and the amount of salt. If your kimchi is freezing, change the storage temperature.

- If the storage temperature is (H), change it to (M) or (L).
- If the storage temperature is (M), change it to (L).
- L=Low Cooling (cold)  
M=Medium Cooling (colder)  
H=High Cooling (coldest)

**Q: Why is my kimchi fermenting too quickly?**

A: If the storage temperature is too high, kimchi will turn sour quickly. To avoid this, change the storage temperature. The storage temperature settings change in the order of (L) → (M) → (H). Kimchi may ferment at different speeds depending on the type of kimchi, seasoning, and temperature at which it is made. Cover kimchi containers with plastic wrap or tightly-fitting lids before storing them to keep kimchi fresh longer.

**Q: Why is my kimchi wilted or mushy?**

A: Adding too little salt will result in kimchi that looks okay at first but wilts and turns mushy as it ferments. Adding salty seafood can also cause kimchi to ferment more quickly and become mushy.

**Q: Why is my kimchi turning dark?**

A: If you store kimchi for a long time, contact with the air will cause it to oxidize and become dark. Cover the inside of the kimchi container with plastic wrap to prevent kimchi from becoming dark.

**Q: There is white mold on the surface of the Kimchi and the cabbage has dried out. What did I do wrong?**

A: If the lid of the kimchi container is not completely closed, the kimchi will come into contact with air, resulting in white yeast forming on the surface of the kimchi or cabbage drying out. Cover containers with plastic wrap before storing to prevent yeast from forming on kimchi.

**Q: Is it normal for ice to form on the lid of the kimchi container?**

A: When kimchi is stored at the best temperature for long-term storage, it is normal for some frost to form on the lid of the container.

## Before Calling for Service

Review this section before calling for service; doing so will save you both time and money.

### Cooling

Problem	Possible Cause	Solutions
<b>Refrigerator compartments are not cooling.</b>	<b>The refrigerator control is set to OFF (some models).</b>	Turn the control ON. Refer to the Setting the Controls section for proper temperature settings.
	<b>Refrigerator is in the defrost cycle.</b>	During the defrost cycle, the temperature of each compartment may rise slightly. Wait 30 minutes and confirm the proper temperature has been restored once the defrost cycle has completed.
	<b>Refrigerator was recently installed.</b>	It may take up to 24 hours for each compartment to reach the desired temperature.
	<b>Refrigerator was recently relocated.</b>	If the refrigerator was stored for a long period of time or moved on its side, it is necessary for the refrigerator to stand upright for 24 hours before connecting it to power.
<b>Cooling system runs too much.</b>	<b>Refrigerator is replacing an older model.</b>	Modern refrigerators require more operating time but use less energy due to more efficient technology.
	<b>Refrigerator was recently plugged in or power restored.</b>	The refrigerator will take up to 24 hours to cool completely.
	<b>The door is opened often or a large amount of food / hot food was added.</b>	Adding food and opening the door warms the refrigerator, requiring the compressor to run longer in order to cool the refrigerator back down. In order to conserve energy, try to get everything you need out of the refrigerator at once, keep food organized so it is easy to find, and close the door as soon as the food is removed. (Refer to the Food Storage Guide.)
	<b>Doors are not closed completely.</b>	Firmly push the doors shut. If they will not shut all the way, see the "Doors will not close correctly or pop open" section.
	<b>Refrigerator is installed in a hot location.</b>	The compressor will run longer under warm conditions. At normal room temperatures (70 °F) expect your compressor to run about 40% to 80% of the time. Under warmer conditions, expect it to run even more often. The refrigerator should not be operated above 110 °F.
	<b>Condenser / back cover is clogged.</b>	Use a vacuum cleaner with an attachment to clean the condenser cover and vents. Do not remove the panel covering the condenser coil area.

## Cooling

Problem	Possible Cause	Solutions
Interior moisture buildup.	Doors are opened often or for long periods of time.	When the doors are opened often or for long periods of time, warm, humid air enters the compartment. This raises the temperature and moisture level within the compartment. To lessen the effect, reduce the frequency and duration of door openings.
	Doors are not closed correctly.	See the "Doors will not close correctly or pop open" section.
	Weather is humid.	Humid weather allows additional moisture to enter the compartments when the doors are opened leading to condensation or frost. Maintaining a reasonable level of humidity in the home will help to control the amount of moisture that can enter the compartments.
	Defrost cycle recently completed.	During the defrost cycle, the temperature of each compartment may rise slightly and condensation may form on the back wall. Wait 30 minutes and confirm that the proper temperature has been restored once the defrost cycle has completed.
	Food is not packaged correctly.	Food stored uncovered or unwrapped, and damp containers can lead to moisture accumulation within each compartment. Wipe all containers dry and store food in sealed packaging to prevent condensation and frost.
Food is freezing in the refrigerator compartment.	Food with high water content was placed near an air vent.	Rearrange items with high water content away from air vents.
	Refrigerator temperature control is set incorrectly.	If the temperature is too cold, adjust the control one increment at a time and wait for the temperature to stabilize. Refer to the Control Panel section for more information.
	Refrigerator is installed in a cold location.	When the refrigerator is operated in temperature below 41°F (5°C), food can freeze in the refrigerator compartment. The refrigerator should not be operated in temperature below 55°F (13°C).
Refrigerator or Freezer section is too warm.	Refrigerator was recently installed.	It may take up to 24 hours for each compartment to reach the desired temperature.
	The air vents are blocked. Cold air circulates from the freezer to the fresh food section and back again through air vents in the wall dividing the two sections.	Locate air vents by using your hand to sense airflow and move all packages that block vents and restrict airflow. Rearrange items to allow air to flow throughout the compartment.

## Cooling

Problem	Possible Cause	Solutions
<b>Refrigerator or Freezer section is too warm.</b>	<b>Doors are opened often or for long periods of time.</b>	When the doors are opened often or for long periods of time, warm, humid air enters the compartment. This raises the temperature and moisture level within the compartment. To lessen the effect, reduce the frequency and duration of door openings.
	<b>Unit is installed in a hot location.</b>	The refrigerator should not be operated in temperatures above 110 °F.
	<b>A large amount of food or hot food was added to the compartment.</b>	Adding food warms the compartment requiring the cooling system to run. Allowing hot food to cool to room temperature before putting it in the refrigerator will reduce this effect.
	<b>Doors not closed correctly.</b>	See the Doors will not close correctly or pop open section in Parts & Features Troubleshooting.
	<b>Temperature control is not set correctly.</b>	If the temperature is too warm, adjust the control one increment at a time and wait for the temperature to stabilize.
	<b>Defrost cycle has recently completed.</b>	During the defrost cycle, the temperature of each compartment may rise slightly and condensation may form on the back wall. Wait 30 minutes and confirm the proper temperature has been restored once the defrost cycle has completed.
<b>Refrigerator is too cold.</b>	<b>Incorrect temperature control settings.</b>	If the temperature is too cold, adjust the control one increment at a time and wait for the temperature to stabilize. Refer to the Control Panel for more information.
<b>Frost or ice crystals form on frozen food (inside of sealed package).</b>	<b>Condensation from food with a high water content has frozen inside of the food package.</b>	This is normal for food items with a high water content.
	<b>Food has been left in the freezer for a long period of time.</b>	Do not store food items with high water content in the freezer for a long period of time.
<b>Frost or ice crystals form on frozen food (outside of package).</b>	<b>Door is opened frequently or for long periods of time.</b>	When the doors are opened often or for long periods of time, warm, humid air enters the compartment. This raises the temperature and moisture level within the compartment. Increased moisture will lead to frost and condensation. To lessen the effect, reduce the frequency and duration of door openings.
	<b>Door is not closing properly.</b>	Refer to the Doors will not close correctly or pop open section in the Troubleshooting section.

## Parts & Features

Problem	Possible Cause	Solutions
Doors will not close correctly or pop open.	Food packages are blocking the door open.	Rearrange food containers to clear the door and door shelves.
	Refrigerator is not leveled properly.	See Leveling in the installation instructions to level refrigerator.
Door is difficult to open.	The gaskets are dirty or sticky.	Clean the gaskets and the surfaces that they touch. Rub a thin coat of appliance polish or kitchen wax on the gaskets after cleaning.
	Door was recently closed.	When you open the door, warmer air enters the refrigerator. As the warm air cools, it can create a vacuum. If the door is hard to open, wait one minute to allow the air pressure to equalize, then see if it opens more easily.
Refrigerator wobbles or seems unstable	Leveling legs are not adjusted properly.	Refer to the Leveling section.
	Floor is not level.	It may be necessary to add shims under the leveling legs or rollers to complete installation.
Lights do not work.	LED interior lighting failure.	The refrigerator compartment lamp is LED interior lighting, and service should be performed by a qualified technician.
The interior of the refrigerator is covered with dust or soot.	The refrigerator is located near a fire source, such as a fireplace, chimney, or candle.	Make sure that the refrigerator is not located near a fire source, such as a fireplace, chimney or candle.

## Noises

Problem	Possible Cause	Solutions
Clicking	The defrost control will click when the automatic defrost cycle begins and ends. The thermostat control (or refrigerator control on some models) will also click when cycling on and off.	Normal Operation
Rattling	Rattling noises may come from the flow of refrigerant, the water line on the back of the unit, or items stored on top of or around the refrigerator.	Normal Operation
	Refrigerator is not resting solidly on the floor.	Floor is weak or uneven or leveling legs need to be adjusted. See the Leveling and Door Alignment section.
	Refrigerator with linear compressor was jarred while running.	Normal Operation
Whooshing	Evaporator fan motor is circulating air through the refrigerator compartment.	Normal Operation
	Air is being forced over the condenser by the condenser fan.	Normal Operation
Gurgling	Refrigerant flowing through the cooling system.	Normal Operation
Popping	Contraction and expansion of the inside walls due to changes in temperature.	Normal Operation
Sizzling	Water dripping on the defrost heater during a defrost cycle.	Normal Operation
Vibrating	If the side or back of the refrigerator is touching a cabinet or wall, some of the normal vibrations may make an audible sound.	To eliminate the noise, make sure that the sides and back cannot vibrate against any wall or cabinet.
Dripping	Water running into the drain pan during the defrost cycle.	Normal Operation
Pulsating or high-pitched sound	Your refrigerator is designed to run more efficiently to keep your food items at the desired temperature. The high efficiency compressor may cause your new refrigerator to run longer than your old one, but it is still more energy efficient than previous models. While the refrigerator is running, it is normal to hear a pulsating or high-pitched sound.	Normal Operation

# LIMITED WARRANTY

## USA

ARBITRATION NOTICE: THIS LIMITED WARRANTY CONTAINS AN ARBITRATION PROVISION THAT REQUIRES YOU AND LG TO RESOLVE DISPUTES BY BINDING ARBITRATION INSTEAD OF IN COURT, UNLESS YOU CHOOSE TO OPT OUT. IN ARBITRATION, CLASS ACTIONS AND JURY TRIALS ARE NOT PERMITTED. PLEASE SEE THE SECTION TITLED "PROCEDURE FOR RESOLVING DISPUTES" BELOW.

Should your LG Refrigerator ("Product") fail due to a defect in materials or workmanship under normal and proper use, during the warranty period set forth below, LG Electronics ("LG") will, at its option, repair or replace the Product. This limited warranty is valid only to the original retail purchaser of the Product and applies only when purchased and used within the United States including U.S. Territories.

WARRANTY PERIOD			
Refrigerator/ Freezer	Sealed System (Condenser, Dryer, Connecting Tube and Evaporator)	Compressor	
One (1) year from the date of original retail purchase	Five (5) years from the date of original retail purchase	Five (5) years from the date of original retail purchase	Linear / Inverter Compressor Only : Parts Only for years 6-10 from the date of original retail purchase (Consumer will be charged for labor)
Parts and Labor (internal/ functional parts only)	Parts and Labor	Parts and Labor	

- Replacement products and parts are warranted for the remaining portion of the original warranty period or ninety (90) days, whichever is greater.
- Replacement products and parts may be new, reconditioned, refurbished, or otherwise factory remanufactured.
- Proof of original retail purchase specifying the Product model and date of purchase is required to obtain warranty service under this limited warranty.

**EXCEPT TO THE EXTENT PROHIBITED BY APPLICABLE LAW, ANY IMPLIED WARRANTY OF MERCHANTABILITY OR FITNESS FOR A PARTICULAR PURPOSE ON THE PRODUCT IS LIMITED IN DURATION TO THE DURATION OF THE ABOVE LIMITED WARRANTY. UNDER NO CIRCUMSTANCES SHALL LG OR ITS U.S. DISTRIBUTORS/DEALERS BE LIABLE FOR ANY INDIRECT, INCIDENTAL, CONSEQUENTIAL, SPECIAL, OR PUNITIVE DAMAGES, INCLUDING, WITHOUT LIMITATION, LOST GOODWILL, LOST REVENUES OR PROFITS, WORK STOPPAGE, IMPAIRMENT OF OTHER GOODS, COST OF REMOVAL AND REINSTALLATION OF THE PRODUCT, LOSS OF USE, OR ANY OTHER DAMAGES WHETHER BASED IN CONTRACT, TORT, OR OTHERWISE. LG'S TOTAL LIABILITY, IF ANY, SHALL NOT EXCEED THE PURCHASE PRICE PAID BY YOU FOR THE PRODUCT.**

Some states do not allow the exclusion or limitation of incidental or consequential damages or limitations on how long an implied warranty lasts, so the above exclusions or limitations may not apply to you. This limited warranty gives you specific legal rights and you may also have other rights that vary from state to state.

### THIS LIMITED WARRANTY DOES NOT COVER:

- Service trips to deliver, pick up, or install, educate how to operate, correct wiring, or correct unauthorized repairs.
- Damage or failure of the Product to perform during power failures and interrupted or inadequate electrical service.
- Damage or failure caused by leaky or broken water pipes, frozen water pipes, restricted drain lines, inadequate or interrupted water supply or inadequate supply of air.
- Damage resulting from operating the product in a corrosive atmosphere or contrary to the product owner's manual.
- Damage or failure to the Product caused by accidents, pests and vermin, lightning, wind, fire, floods, acts of God, or any other causes beyond the control of LG.

## 32 LIMITED WARRANTY

---

- Damage or failure caused by unauthorized modification or alteration, or if used for other than the intended purpose.
- Damage or failure resulting from misuse, abuse, improper installation, repair, or maintenance. Improper repair includes use of parts not authorized by LG. Improper installation or maintenance includes installation or maintenance contrary to the Product owner's manual.
- Damage or failure caused by incorrect electrical current, voltage, or plumbing codes.
- Damage or failure caused by transportation and handling, including scratches, dents, chips, and/or other damage to the finish of the Product, unless such damage is reported within one (1) week of delivery.
- Damage or missing items to any display, open box, or discounted Product.
- Refurbished Product or any Product sold "As Is", "Where Is", "With all Faults", or similar disclaimer.
- Products with original serial numbers that have been removed, altered, or cannot be readily determined.
- Increases in utility costs and additional utility expenses.
- Any noises associated with normal operation.
- Use of accessories (e.g., water filters, etc.), components, or consumable cleaning products that are not authorized by LG.
- Replacement of light bulbs, filters, or any consumable parts.
- When Product is used for other than normal and proper household use (e.g. commercial or industrial use, offices, and recreational facilities or vehicles) or contrary to the instructions outlined in the Product's owner's manual.
- Costs associated with removal and reinstallation of your Product for repairs.
- Shelves, door bins, drawers, handle and accessories, except for internal/functional parts covered under this limited warranty.

**The cost of repair or replacement under these excluded circumstances shall be borne by the consumer.**

TO OBTAIN WARRANTY SERVICE AND ADDITIONAL INFORMATION

Call 1-800-243-0000 and select the appropriate option from the menu.

Or visit our website at <http://www.lg.com>.

Or by mail: LG Electronics Customer Service P.O. Box 240007 Huntsville, AL 35813 ATTN: CIC

### **PROCEDURE FOR RESOLVING DISPUTES:**

ALL DISPUTES BETWEEN YOU AND LG ARISING OUT OF OR RELATING IN ANY WAY TO THIS LIMITED WARRANTY OR THE PRODUCT SHALL BE RESOLVED EXCLUSIVELY THROUGH BINDING ARBITRATION, AND NOT IN A COURT OF GENERAL JURISDICTION. BINDING ARBITRATION MEANS THAT YOU AND LG ARE EACH WAIVING THE RIGHT TO A JURY TRIAL AND TO BRING OR PARTICIPATE IN A CLASS ACTION.

**Definitions.** For the purposes of this section, references to "LG" mean LG Electronics U.S.A., Inc., its parents, subsidiaries and affiliates, and each of their officers, directors, employees, agents, beneficiaries, predecessors in interest, successors, assigns and suppliers; references to "dispute" or "claim" shall include any dispute, claim or controversy of any kind whatsoever (whether based in contract, tort, statute, regulation, ordinance, fraud, misrepresentation or any other legal or equitable theory) arising out of or relating in any way to the sale, condition or performance of the product or this Limited Warranty.

**Notice of Dispute.** In the event you intend to commence an arbitration proceeding, you must first notify LG in writing at least 30 days in advance of initiating the arbitration by sending a letter to LG at LG Electronics, USA, Inc. Attn: Legal Department- Arbitration 1000 Sylvan Ave, Englewood Cliffs 07632. You and LG agree to engage in good faith discussions in an attempt to amicably resolve your claim. The notice must provide your name, address, and telephone number; identify the product that is the subject of the claim; and describe the nature of the claim and the relief being sought. If you and LG are unable to resolve the dispute within 30 days, either party may proceed to file a claim for arbitration.



**Agreement to Binding Arbitration and Class Action Waiver.** Upon failure to resolve the dispute during the 30 day period after sending written notice to LG, you and LG agree to resolve any claims between us only by binding arbitration on an individual basis, unless you opt out as provided below. Any dispute between you and LG shall not be combined or consolidated with a dispute involving any other person's or entity's product or claim. More specifically, without limitation of the foregoing, any dispute between you and LG shall not under any circumstances proceed as part of a class or representative action. Instead of arbitration, either party may bring an individual action in small claims court, but that small claims court action may not be brought on a class or representative basis.

**Arbitration Rules and Procedures.** To begin arbitration of a claim, either you or LG must make a written demand for arbitration. The arbitration will be administered by the American Arbitration Association ("AAA") and will be conducted before a single arbitrator under the AAA's Consumer Arbitration Rules that are in effect at the time the arbitration is initiated (referred to as the "AAA Rules") and under the procedures set forth in this section. The AAA Rules are available online at [www.adr.org/consumer](http://www.adr.org/consumer). Send a copy of your written demand for arbitration, as well as a copy of this provision, to the AAA in the manner described in the AAA Rules. You must also send a copy of your written demand to LG at LG Electronics, USA, Inc. Attn: Legal Department- Arbitration 1000 Sylvan Avenue Englewood Cliffs, NJ 07632. If there is a conflict between the AAA Rules and the rules set forth in this section, the rules set forth in this section will govern. This arbitration provision is governed by the Federal Arbitration Act. Judgment may be entered on the arbitrator's award in any court of competent jurisdiction. All issues are for the arbitrator to decide, except that issues relating to the scope and enforceability of the arbitration provision and to the arbitrability of the dispute are for the court to decide. The arbitrator is bound by the terms of this provision.

**Governing Law.** The law of the state of your residence shall govern this Limited Warranty and any disputes between us except to the extent that such law is preempted by or inconsistent with applicable federal law.

**Fees/Costs.** You do not need to pay any fee to begin an arbitration. Upon receipt of your written demand for arbitration, LG will promptly pay all arbitration filing fees to the AAA unless you seek more than \$25,000 in damages, in which case the payment of these fees will be governed by the AAA Rules. Except as otherwise provided for herein, LG will pay all AAA filing, administration and arbitrator fees for any arbitration initiated in accordance with the AAA Rules and this arbitration provision. If you prevail in the arbitration, LG will pay your attorneys' fees and expenses as long as they are reasonable, by considering factors including, but not limited to, the purchase amount and claim amount. Notwithstanding the foregoing, if applicable law allows for an award of reasonable attorneys' fees and expenses, an arbitrator can award them to the same extent that a court would. If the arbitrator finds either the substance of your claim or the relief sought in the demand is frivolous or brought for an improper purpose (as measured by the standards set forth in Federal Rule of Civil Procedure 11(b)), then the payment of all arbitration fees will be governed by the AAA Rules. In such a situation, you agree to reimburse LG for all monies previously disbursed by it that are otherwise your obligation to pay under the AAA Rules. Except as otherwise provided for, LG waives any rights it may have to seek attorneys' fees and expenses from you if LG prevails in the arbitration.

**Hearings and Location.** If your claim is for \$25,000 or less, you may choose to have the arbitration conducted solely on the basis of (1) documents submitted to the arbitrator, (2) through a telephonic hearing, or (3) by an in-person hearing as established by the AAA Rules. If your claim exceeds \$25,000, the right to a hearing will be determined by the AAA Rules. Any in-person arbitration hearings will be held at a location within the federal judicial district in which you reside unless we both agree to another location or we agree to a telephonic arbitration.

**Opt Out.** You may opt out of this dispute resolution procedure. If you opt out, neither you nor LG can require the other to participate in an arbitration proceeding. To opt out, you must send notice to LG no later than 30 calendar days from the date of the first consumer purchaser's purchase of the product by either: (i) sending an e-mail to [optout@lge.com](mailto:optout@lge.com), with the subject line: "Arbitration Opt Out" or (ii) calling 1-800-980-2973. You must include in the opt out e-mail or provide by telephone: (a) your name and address; (b) the date on which the product was purchased; (c) the product model name or model number; and (d) the serial number (the serial number can be found (i) on the product; or (ii) online by accessing <https://www.lg.com/us/support/repair-service/schedule-repair-continued> and clicking on "Find My Model & Serial Number").

You may only opt out of the dispute resolution procedure in the manner described above (that is, by e-mail or telephone); no other form of notice will be effective to opt out of this dispute resolution procedure. Opting out of this dispute resolution procedure will not affect the coverage of the Limited Warranty in any way, and you will continue to enjoy the full benefits of the Limited Warranty. If you keep this product and do not opt out, then you accept all terms and conditions of the arbitration provision described above.

# LIMITED WARRANTY

## CANADA

ARBITRATION NOTICE: THIS LIMITED WARRANTY CONTAINS AN ARBITRATION PROVISION THAT REQUIRES YOU AND LG TO RESOLVE DISPUTES BY BINDING ARBITRATION INSTEAD OF IN COURT, UNLESS THE LAWS OF YOUR PROVINCE OR TERRITORY DO NOT PERMIT THAT, OR, IN OTHER JURISDICTIONS, IF YOU CHOOSE TO OPT OUT. IN ARBITRATION, CLASS ACTIONS AND JURY TRIALS ARE NOT PERMITTED. PLEASE SEE THE SECTION TITLED "PROCEDURE FOR RESOLVING DISPUTES" BELOW.

Should your LG Refrigerator ("Product") fail due to a defect in materials or workmanship under normal and proper use, during the warranty period set forth below, LG Electronics Canada, Inc. ("LGECI") will, at its option, repair or replace the Product upon receipt of proof of the original retail purchase. This limited warranty is valid only to the original retail purchaser of the Product and applies only to a Product distributed, purchased and used within Canada, as determined at the sole discretion of LGECI.

<b>WARRANTY PERIOD (Note: If the original date of purchase cannot be verified, the warranty will begin sixty (60) days from the date of manufacture)</b>			
<b>Refrigerator</b>	<b>Sealed System (Condenser, Dryer, Connecting Tube and Evaporator)</b>		<b>Linear / Inverter Compressor</b>
<b>One (1) year from the date of original retail purchase</b>	<b>One (1) year from the date of original retail purchase</b>	<b>Seven (7) years from the date of original retail purchase</b>	<b>Ten (10) years from the date of original retail purchase</b>
Parts and Labor (internal/functional parts only)	Parts and Labor	Parts only (Consumer will be charged for labor)	Part only (Consumer will be charged for labor)

- Replacement products and parts are warranted for the remaining portion of the original warranty period or ninety (90) days, whichever is greater.
- Replacement products and parts may be new, reconditioned, refurbished, or otherwise factory remanufactured, all at the sole discretion of LGECI.
- Proof of original retail purchase specifying the Product model and date of purchase is required to obtain warranty service under this Limited Warranty.

**LGECI'S SOLE LIABILITY IS LIMITED TO THE LIMITED WARRANTY SET OUT ABOVE. EXCEPT AS EXPRESSLY PROVIDED ABOVE, LGECI MAKES NO, AND HEREBY DISCLAIMS, ALL OTHER WARRANTIES AND CONDITIONS RESPECTING THE PRODUCT, WHETHER EXPRESS OR IMPLIED, INCLUDING BUT NOT LIMITED TO, ANY IMPLIED WARRANTY OR CONDITION OF MERCHANTABILITY OR FITNESS FOR A PARTICULAR PURPOSE, AND NO REPRESENTATIONS SHALL BE BINDING ON LGECI. LGECI DOES NOT AUTHORIZE ANY PERSON TO CREATE OR ASSUME FOR IT ANY OTHER WARRANTY OBLIGATION OR LIABILITY IN CONNECTION WITH THE PRODUCT. TO THE EXTENT THAT ANY WARRANTY OR CONDITION IS IMPLIED BY LAW, IT IS LIMITED TO THE WARRANTY PERIOD SET OUT ABOVE. UNDER NO CIRCUMSTANCES SHALL LGECI, THE MANUFACTURER OR DISTRIBUTOR OF THE PRODUCT, BE LIABLE FOR ANY INCIDENTAL, CONSEQUENTIAL, SPECIAL, DIRECT, INDIRECT, PUNITIVE OR EXEMPLARY DAMAGES, INCLUDING, WITHOUT LIMITATION, LOSS OF GOODWILL, LOST PROFITS, LOSS OF ANTICIPATED PROFITS, LOST REVENUE, LOSS OF USE, OR ANY OTHER DAMAGE, WHETHER ARISING DIRECTLY OR INDIRECTLY FROM ANY CONTRACTUAL BREACH, FUNDAMENTAL BREACH, TORT OR OTHERWISE, OR FROM ANY ACTS OR OMISSIONS. LGECI'S TOTAL LIABILITY, IF ANY, SHALL NOT EXCEED THE PURCHASE PRICE PAID BY YOU FOR THE PRODUCT.**

This Limited Warranty gives you specific legal rights. You may also have other rights that vary from province to province depending on applicable provincial laws. Any term of this Limited Warranty that negates or varies any implied condition or warranty under provincial law is severable where it conflicts with such provincial law without affecting the remainder of this warranty's terms.

**THIS LIMITED WARRANTY DOES NOT COVER:**

- Service trips to i) deliver, pick up, or install or; educate on how to operate the Product; ii) correct wiring or plumbing; or iii) correct unauthorized repairs or installations of the Product;
- Damage or failure of the Product to perform during power failures and interrupted or inadequate electrical service;
- Damage or failure caused by leaky or broken water pipes, frozen water pipes, restricted drain lines, inadequate or interrupted water supply or inadequate supply of air;
- Damage or failure resulting from operating the Product in a corrosive atmosphere or contrary to the instructions outlined in the Product's owner's manual;
- Damage or failure to the Product caused by accidents, pests and vermin, lightning, wind, fire, floods, acts of God, or any other causes beyond the control of LGECI or the manufacturer;
- Damage or failure resulting from misuse, abuse, improper installation, repair, or maintenance of the Product. Improper repair includes use of parts not authorized or specified by LGECI. Improper installation or maintenance includes installation or maintenance contrary to the Product's owner's manual;
- Damage or failure caused by unauthorized modification or alteration of the Product, or if used for other than the intended household purpose/use of the Product, or damage or failure resulting from any water leakage due to improper installation of the Product;
- Damage or failure caused by incorrect electrical current, voltage or plumbing codes;
- Damage or failure caused by use that is other than normal household use, including, without limitation, commercial or industrial use, including use in commercial offices or recreational facilities, or as otherwise outlined in the Product's owner's manual;
- Damage or failure caused by the use of any accessories, components or cleaning products, including, without limitation, water filters, that are not approved/authorized by LGECI;
- Replacement of the water filter cartridge due to water pressure that is outside the specified operating range or due to excessive sediment in the water supply;
- Damage or failure caused by transportation and handling, including scratches, dents, chips and/or other damage to the finish of the Product, **unless** such damage results from defects in materials or workmanship and is reported to LGECI within one (1) week of delivery of the Products;
- Damage or missing items to any display, open box, refurbished or discounted Product;
- Refurbished Product or any Product sold "As Is", "Where Is", "With all Faults", or any similar disclaimer;
- Products with original serial numbers that have been removed, altered or cannot be readily determined at the discretion of LGECI;
- Increases in utility costs and additional utility expenses in any way associated with the Product;
- Any noises associated with normal operation of the Product;
- Replacement of light bulbs, filters, fuses or any other consumable parts;
- Replacement of any part that was not originally included with the Product;
- Costs associated with removal and/or reinstallation of the Product for repairs; and
- Shelves, door bins, drawers, handle and accessories to the Product, except for internal/functional parts covered under this Limited Warranty.
- Coverage for "in Home" repairs, for products in-warranty, will be provided if the Product is within a 150 km radius from the nearest authorized service center (ASC), as determined by LG Canada. If your Product is located outside a 150 km radius from a ASC, as determined by LG Canada, it will be your responsibility to bring the Product, at your sole expense, to the ASC for in-warranty repair.

**All costs and expenses associated with the above excluded circumstances, listed under the heading, This Limited Warranty Does Not Cover, shall be borne by the consumer.**

TO OBTAIN WARRANTY SERVICE AND ADDITIONAL INFORMATION, PLEASE CALL OR VISIT OUR WEBSITE:

Call 1-888-542-2623 (7 A.M. to 12 A.M., 365 days a year) and select the appropriate option from the menu, or. Visit our website at <http://www.lg.com>

**PROCEDURE FOR RESOLVING DISPUTES:**

EXCEPT WHERE PROHIBITED AT LAW, ALL DISPUTES BETWEEN YOU AND LG ARISING OUT OF OR RELATING IN ANY WAY TO THIS LIMITED WARRANTY OR THE PRODUCT SHALL BE RESOLVED EXCLUSIVELY THROUGH BINDING ARBITRATION, AND NOT IN A COURT OF GENERAL JURISDICTION. EXCEPT WHERE PROHIBITED AT LAW, YOU AND LG BOTH IRREVOCABLY AGREE TO WAIVE THE RIGHT TO A JURY TRIAL AND TO BRING OR PARTICIPATE IN A CLASS ACTION.

**Definitions.** For the purposes of this section, references to “LG” mean LG Electronics Canada, Inc., its parents, subsidiaries and affiliates, and each of their officers, directors, employees, agents, beneficiaries, predecessors in interest, successors, assigns and suppliers; references to “dispute” or “claim” shall include any dispute, claim or controversy of any kind whatsoever (whether based in contract, tort, statute, regulation, ordinance, fraud, misrepresentation or any other legal or equitable theory) arising out of or relating in any way to the sale, condition or performance of the product or this Limited Warranty.

**Notice of Dispute.** In the event you intend to commence an arbitration proceeding, you must first notify LG in writing at least 30 days in advance of initiating the arbitration by sending a letter to LGECI Legal Team at 20 Norelco Drive, North York, Ontario, Canada M9L 2X6 (the “Notice of Dispute”). You and LG agree to engage in good faith discussions in an attempt to amicably resolve your claim. The notice must provide your name, address, and telephone number; identify the product that is the subject of the claim; and describe the nature of the claim and the relief being sought. If you and LG are unable to resolve the dispute within 30 days of LG’s receipt of the Notice of Dispute, the dispute shall be resolved by binding arbitration in accordance with the procedure set out herein. You and LG both agree that, during the arbitration proceeding, the terms (including any amount) of any settlement offer made by either you or LG will not be disclosed to the arbitrator until the arbitrator determines the dispute.

**Agreement to Binding Arbitration and Class Action Waiver.** Upon failure to resolve the dispute during the 30 day period after LG’s receipt of the Notice of Dispute, you and LG agree to resolve any claims between you and LG only by binding arbitration on an individual basis, unless you opt out as provided below, or you reside in a jurisdiction that prevents full application of this clause in the circumstances of the claims at issue (in which case if you are a consumer, this clause will only apply if you expressly agree to the arbitration). To the extent permitted by applicable law, any dispute between you and LG shall not be combined or consolidated with a dispute involving any other person’s or entity’s product or claim. More specifically, without limitation of the foregoing, except to the extent such a prohibition is not permitted at law, any dispute between you and LG shall not under any circumstances proceed as part of a class or representative action. Instead of arbitration, either party may bring an individual action in small claims court, but that small claims court action may not be brought on a class or representative basis except to the extent this prohibition is not permitted at law in your province or territory of jurisdiction as it relates to the claims at issue between you and LG.

**Arbitration Rules and Procedures.** To begin arbitration of a claim, either you or LG must make a written demand for arbitration. The arbitration will be private and confidential, and conducted on a simplified and expedited basis before a single arbitrator chosen by the parties under the provincial or territorial commercial arbitration law and rules of the province or territory of your residence. You must also send a copy of your written demand to LG at LG Electronics, Canada, Inc., Attn: Legal Department- Arbitration, 20 Norelco Drive, North York, Ontario M9L 2X6. This arbitration provision is governed by your applicable provincial or territorial commercial arbitration legislation. Judgment may be entered on the arbitrator’s award in any court of competent jurisdiction. All issues are for the arbitrator to decide, except that, issues relating to the scope and enforceability of the arbitration provision and to the arbitrability of the dispute are for the court to decide. The arbitrator is bound by the terms of this provision.

**Governing Law.** The law of the province or territory of your purchase shall govern this Limited Warranty and any disputes between you and LG except to the extent that such law is preempted by or inconsistent with applicable federal or provincial/territorial law. Should arbitration not be permitted for any claim, action, dispute or controversy between you and LG, you and LG attorn to the exclusive jurisdiction of the courts of the province or territory of your purchase for the resolution of the claim, action, dispute or controversy between you and LG.

**Fees/Costs.** You do not need to pay any fee to begin an arbitration. Upon receipt of your written demand for arbitration, LG will promptly pay all arbitration filing fees unless you seek more than \$25,000 in damages, in which case the payment of these fees will be governed by the applicable arbitration rules. Except as otherwise provided for herein, LG will pay all filing, administration and arbitrator fees for any arbitration initiated in accordance with the applicable arbitration rules and this arbitration provision. If you prevail in the arbitration, LG will pay your attorneys' fees and expenses as long as they are reasonable, by considering factors including, but not limited to, the purchase amount and claim amount. Notwithstanding the foregoing, if applicable law allows for an award of reasonable attorneys' fees and expenses, an arbitrator can award them to the same extent that a court would. If the arbitrator finds either the substance of your claim or the relief sought in the demand is frivolous or brought for an improper purpose (as measured by the applicable laws), then the payment of all arbitration fees will be governed by the applicable arbitration rules. In such a situation, you agree to reimburse LG for all monies previously disbursed by it that are otherwise your obligation to pay under the applicable arbitration rules. Except as otherwise provided for, LG waives any rights it may have to seek attorneys' fees and expenses from you if LG prevails in the arbitration.

**Hearings and Location.** If your claim is for \$25,000 or less, you may choose to have the arbitration conducted solely (1) on the basis of documents submitted to the arbitrator, (2) through a telephonic hearing, or (3) by an in-person hearing as established by the applicable arbitration rules. If your claim exceeds \$25,000, the right to a hearing will be determined by the applicable arbitration rules. Any in-person arbitration hearings will be held at the nearest, most mutually-convenient arbitration location available within the province or territory in which you reside unless you and LG both agree to another location or agree to a telephonic arbitration.

**Severability and Waiver.** If any portion of this Limited Warranty (including these arbitration procedures) is unenforceable, the remaining provisions will continue in full force and effect to the maximum extent permitted by applicable law. Should LG fail to enforce strict performance of any provision of this Limited Warranty (including these arbitration procedures), it does not mean that LG intends to waive or has waived any provision or part of this Limited Warranty.

**Opt Out.** You may opt out of this dispute resolution procedure. If you opt out, neither you nor LG can require the other to participate in an arbitration proceeding. To opt out, you must send notice to LG no later than 30 calendar days from the date of the first consumer purchaser's purchase of the product by either (i) sending an e-mail to [optout@lge.com](mailto:optout@lge.com), with the subject line: "Arbitration Opt Out;" or (ii) calling 1-800-980-2973. You must include in the opt out e-mail or provide by telephone: (a) your name and address; (b) the date on which the product was purchased; (c) the product model name or model number; and

(d) the serial number (the serial number can be found (i) on the product; or (ii) online by accessing [https://www.lg.com/ca\\_en/support/repair-service/schedule-repair](https://www.lg.com/ca_en/support/repair-service/schedule-repair) and clicking on "Find My Model & Serial Number").

In the event that you "Opt Out", the law of the province or territory of your residence shall govern this Limited Warranty and any disputes between you and LG except to the extent that such law is preempted by or inconsistent with applicable federal or provincial/territorial law. Should arbitration not be permitted for any claim, action, dispute or controversy between you and LG, you and LG agree to attorn to the exclusive jurisdiction of the courts of the province or territory of your residence for the resolution of the claim, action, dispute or controversy between you and LG.

You may only opt out of the dispute resolution procedure in the manner described above (that is, by e-mail or telephone); no other form of notice will be effective to opt out of this dispute resolution procedure. Opting out of this dispute resolution procedure will not affect the coverage of the Limited Warranty in any way, and you will continue to enjoy the full benefits of the Limited Warranty. If you keep this product and do not opt out, then you accept all terms and conditions of the arbitration provision described above.

**Conflict of Terms.** In the event of a conflict or inconsistency between the terms of this Limited Warranty and the End User License Agreement ("EULA") in regards to dispute resolution, the terms of this Limited Warranty shall control and govern the rights and obligations of the parties and shall take precedence over the EULA.











LG Customer Information Center

For inquiries or comments,  
visit [www.lg.com](http://www.lg.com) or call:

1-800-243-0000 USA

1-888-542-2623 CANADA

Register your product Online!

[www.lg.com](http://www.lg.com)